



VALLEY CHROME PLATING



QUALITY SINCE 1961

BUMPERS & ACCESSORIES

CATALOG

version 26.4



ISO 9001
ISO 14001

VALLEY CHROME PLATING



For **OVER 60 YEARS**, the trucking industry has put its trust in Valley Chrome Plating, Inc./STAINLESS. We are a hard working, family-owned American business. A huge THANK YOU to those who have helped us build our reputation for stellar aftermarket bumpers, visors, light panels, LED accessory lighting and more!

Please visit us on our website and join the excitement on our social media pages by posting pictures of our products on your trucks. Our knowledgeable staff is ready to serve you by phone as well, by calling 1.800.354.0976.

TABLE OF CONTENTS

BUMPERS

Part Numbering Guide	7
Autocar	8
Ford	9-10
Freightliner	11-26
GMC	27-29
Hino	30
International	31-38
Kenworth	39-48
Mack	48-59
Peterbilt	60-74
Sterling	75-76
Volvo	77-82
Western Star & White	83-88
Universal Mount Blank Bumpers	89
Blind Mount Bumpers	90
Bumper Customization Options	91-93
Bumper Mounting Bolt Kits	94

UNIVERSAL ACCESSORIES

Flap Weights, Tank Straps & Tag Hangers ...	97
Permit Panels	98
Ridged Permit Panels & Beacon Light Brackets	99
Airline Boxes	100
Deck Plates & Front Deck Plate Tool Box ...	101
Rear Frame Tool Box	102
Frame Steps	103
Rear Window Visors	104
Rear Frame Fillers	105
Lower Rear Frame Fillers	106
Retail Display - LEDs	107
LED Light Option Chart	108
Blank Light Cutout Options	109
Universal LED Lights & Watermelon Lights	110-115
Watermelon Light Brackets	116
Wire Harnesses	117

PETERBILT MODEL 359 ACCESSORIES

Cab Panel 3.5" & Hood Extensions	119
Misc. Trim Pieces	120
Standard Mount Stainless Visors, Gangster	
Stainless Visors & Wicked Visors	121
Air Deflectors, Fuel Tank Strap Covers & Misc.	
Trim Pieces	122

PETERBILT MODELS 365 & 367 ACCESSORIES

Cab Panel 4"	124
Sleeper Panels 4"	125
Sleeper Extension Panels 4"	126
Air Cleaner Light Boxes & Bug Shields	127

PETERBILT MODEL 379 ACCESSORIES

One-Piece Cab/Hood Extension Panels	130
4" & 6" Cab Panels	131
4" & 6" Hood Extension Panels	132
4" & 6" Sleeper Panels	133
4" & 6" Sleeper Extension Panels	134
Air Cleaner Light Boxes Vortex	135
Mirror Light Boxes	136
Bumper/Grille Trim & Fender Guards	137
Bug Shields	138
Blinker Bars & Fender Support Covers	139
Sleeper Filler Panels & Shock Covers	140
Air Deflectors & Fuel Tank Strap Covers	141
Fuel Tank Fairings	142
Emblems & Misc. Trim Pieces	143-144
Battery Boxes & Tool Boxes	145
Tool & Battery Box Covers	146

PETERBILT MODEL 384

4" & 6" Cab Panels	148
4" & 6" Sleeper Panels	149
4" & 6" Sleeper Extension Panels	150

PETERBILT MODEL 386

2.5" Cab Panels & Exhaust Filler Panel	152
2.5" Sleeper Panels	153
2.5" Sleeper Extension Panels, Bug Shields	154

PETERBILT MODELS 388 & 389

4" & 6" Formed Cab Panels	156
One-Piece Cab/Hood Extension Panels for DEF &	
No DEF System	157-159
4" & 6" Cab Panels	160

Table of Contents continued on next page

TABLE OF CONTENTS

Table of Contents continued from previous page

PETERBILT MODELS 388 & 389 (cnt'd)

4" & 6" Cab Panels for Def & No Def System	161
4" & 6" Sleeper Panels.....	162
4" & 6" Hood Extension Panels	163-164
388 Cab Panel DEF System	165
4" & 6" Sleeper Extension Panels.....	166
Air Cleaner Light Boxes Donaldson	167
Mirror Light Boxes	168
Bumper & Grille Trim, Fender Guards & Bug Shields.....	169
Emblems, Fender Trim & Hood Trim	170
Blinker Bars & Fender Support Cover	171
Stainless Visors & Sleeper Filler Panels.....	172
Misc. Trim Pieces	173-174
Sleeper Shock Covers & Air Deflectors.....	175
Fuel Tank Strap Covers & Exhaust Covers .	176
Tool & Battery Box Covers	177
Battery Boxes, Tool Boxes & Box Step High-lights/Protectors.....	178

PETERBILT MODEL 567

Cab Panels, Sleeper Panels, Hood Extensions & Fender Guards	180
Bug Shields & Fuel Tank Strap Covers	181
Stainless Visors	182

PETERBILT MODEL 579

Cab Panel & Sleeper Panels.....	185
DEF System Panels.....	186
Misc. Trim Pieces	187-188
Stainless Visors	189
Sleeper Shock Covers, Tank Fairing Highlight & Kick Panel Trim	190

PETERBILT MODEL 587

Fender Trim & Stainless Visors	192
Misc. Trim Pieces	193

PETERBILT MODEL 589

Fender Guards, Air Cleaner Light Bars, Cab & Sleeper Panels	196
Universal Watermelon Light Brackets, Tag Hangers & Panels.....	197

ACCESSORIES FOR ALL PETERBILT MODELS

Hood Emblems & Hood Latch Guards	199-200
Key Guards & Misc. Trim Pieces	201
Bug Shield for model 387, Window Trim & Sleeper Window Lower Looks	202
Stainless Visors	203-206
Sleeper Wraps & Rear Frame Covers	207
DEF Tank Covers & Fuel Tank Wraps	208

KENWORTH MODEL W900

Cab Panels	210
Sleeper Panels.....	211
Hood Extension Panels & Sleeper Extension Panels	212
Air Cleaner Light Boxes	213
Air Cleaner Fairings	214
Exterior Window Trim, Exhaust Shields & Bug Shields	215
Blinker Bars & Flap Weight	216
Fender Guards, Battery & Tool Box Covers	217
Hood & Grille Trim	218
Stainless Sun Visors	219-221
Catalytic System Box Highlights, DEF Tank Cover & Stainless Deck Plates	222
Fuel Tank Fairings.....	223
Lower Hood Panels & Center Hood Trim...	224

KENWORTH MODEL T600

Sleeper Panels & Sleeper Extension Panels	226
Stainless Grilles & Bug Shields.....	227
Battery/Tool Box Covers & Side Marker Trim	228

KENWORTH MODEL T660

Cab Panels, Bug Shields & Stainless Sun Visors	230
Gangster Visors & Boltless Wicked Visors .	231
Battery & Tool Box Covers	232

Table of Contents continued on next page

TABLE OF CONTENTS

Table of Contents continued from previous page

KENWORTH T680

Cab & Cowl Panels, Sleeper Extension Panels & Door and Window Trim.....	234
Bug Shields, Fender Guards & Stainless Sun-Visors	235
DEF Tank Cover.....	236

KENWORTH T800 & T880

Sleeper Panels & Sleeper Extension Panels.....	238
Bug Shields, Fender Guards & Stainless Sun-Visors	239
Gangster Visors & Boltless Wicked Visors ..	240
Battery & Tool Box Covers	241
Exterior Window Trim, Door Handle Trim, Lower Look	241 & Air Deflectors 242
Emblem Accents & Hood Latch Guards	243
Sleeper Window Trim, Rear Frame Covers & Stainless Fuel Tank Wraps.....	244

FREIGHTLINER FLD/CLASSIC

Cab Panels 4" & Sleeper Panels	246
Hood Latch Guards, Hood Trim & Lowered Look Window Panels.....	247
Misc. Trim Pieces & Air Cleaner Light Boxes.....	248
Fender Guards, Stainless Trim For Plastic Bumpers & Headlight Visors.....	249
Bug Shields.....	250
Drop Visors	251
Wicked Boltless Visors.....	252

FREIGHTLINER CENTURY & COLUMBIA

Cab Panels 4", Sleeper Panels & Misc.-Trim Pieces	254
Stainless Trim for Plastic Bumpers & Bug Shields ..	255
Sun Visors.....	256

FREIGHTLINER CORONADO 2002-2009 & GLIDER KITS

Bug Shields & Sun Visors	258
--------------------------------	-----

FREIGHTLINER CASCADIA 2017 & OLDER "P3"

Cab Panels 4" & Sleeper Panels	260
Fairing Panels	261
Fender Trim, Hood & Door Trim & Lowered Look-Window Panels.....	262
Stainless Trim For Plastic Bumpers & Bug Shields ..	263
Sun Visors.....	264
Fuel Tank Covers, Battery Box Covers & Steps & Catalytic Covers	265
Emblem Accents, Permit Panels & Fuel Tank-Fairing.....	266

INTERNATIONAL

Sun Visors.....	268
-----------------	-----

VOLVO VNL

Hood & Fender Trim, Bug Shield & Stainless Trim For Factory Visors	270
Fairing Highlights.....	271

VOLVO VT SERIES

Cab Panels & Sleeper Panels.....	273
Hood Extension Panels & Hood & Fender Trim ..	274
Hood & Fender Trim, Bug Shield & Sun Visors. ..	275
Battery Box Cover & Fuel Tank Fairings	276

WESTERN STAR 4700SF

Cab Panels, Fender Guards & Panels	278
Bug Shields, Radiator Rock Guard & Sun Visors ..	279

WESTERN STAR 5700XE

Sun Visors & Bug Shields	(279 Cont'd)
--------------------------------	--------------

WESTERN STAR 47X & 49

Sun Visors, Sleeper Extension Panels & Air Intake Screens	279
---	-----

TURBOWINGS

The Turbowing Advantage	281
Pickup Truck Wings/Mounting Kits.....	282
Aerolight 700 Series Intro & 900 Series Intro..	283
Peterbilt Wings/Mounting Kits	284
Kenworth Wings/Mounting Kits	285
Freightliner Wings/Mounting Kits.....	286
International Wings/Mounting Kits.....	287
Western Star Wings/Mounting Kits	288
Pro Tail Wings	289

NOTES	290
--------------------	-----

WARRANTY AND RETURN POLICIES	291
---	-----

BUMPER PART NUMBERING & OPTIONS GUIDE

How our BUMPER part numbering system works:

We use a "smart" part number. Every digit has a meaning, which indicates how we build your bumper. Make sure all digits are correct to have your bumper built correctly!

Example Part Number:

HC - 0010 - 06 - 21BY

TRUCK MAKE
H = Peterbilt

TRUCK MODEL
C = Model 379

Search the following bumper pages to find this two digit code.

CUTOUPS
0010 = mounting holes and tow hole. Visit the bumper pages in this catalog for available cutout options.

END STYLE
06 = 18 inch Rolled End Square. See this chart for end style choices. Varies by make/model. See bumper pages.

OPTIONS
21BY = 21 open Bullseye 3/4 light holes. No code needed here if the rest of the part number completes your bumper. See p. 88-91 for some options.

TAPER ROLLED END

"STANDARD TAPER"

12"	01
16"	02

TAPER HAND FORM

12"	91
14"	30
16"	92
18"	03
20"	31
22"	32

SETBACK AXLE

9"	29
12 to 14"	15
16"	16
18"*	17
20"*	34

AMERICAN EAGLE BOXED END

12"	54
16"	55
18"	56
20"	57
22"	58

WITH 8" EARS

AMERICAN EAGLE BOXED END

12"	54A
16"	55A
18"	56A
20"	57A
22"	58A

WITH 6" EARS

SQUARE ROLLED END

"TEXAS SQUARE"

18"	06
20"	41
22"	42

SQUARE ROLLED HAND FORM

10"	00
12"	04
14"	21
16"	05
18"	96
20"	97
22"	98

SET FORWARD AXLE

12"-13"	18
16"	19
18"	20
20"	35

AMERICAN EAGLE ROLLED END

12"	64
16"	65
18"	66
20"	67
22"	68

WITH 8" EARS

AMERICAN EAGLE ROLLED END

12"	64A
16"	65A
18"	66A
20"	67A
22"	68A

WITH 6" EARS

BOXED END

"SQUARE BOXED"

12"	09
16"	10
18"	11
20"	51
22"	52

OPEN END

10"	27
12"	12
14"	25
14" (w/Taper)	26
16"	13
18"	14
20"	61
22"	62

WRAP AROUND "FACTORY STYLE"

10"	24
12"	22
14"	38
16"	23

Example: -561T

CUSTOM TAPERS:

Add "1T" for 1" TAPER
Example: -561T = AMER. EAGLE BOX, 18" to 17" TAPER
Add "2T" for 2" TAPER
Example: -742T = BOXED END, 20" to 18" TAPER

GULLWING

16"	07
-----	----

BOXED END TAPER

12"	70
14"	71
16"	72
18"	73
20"	74
22"	75

ROADRUNNER

12"	111
16"	112
18"	113
20"	114
22"	115

45° MITRE END

AMERICAN ROADRUNNER

12"	101
16"	102
18"	103
20"	104
22"	105

45° MITRE END



* NOTE: No Warranty on setback bumpers 20" and wider, except COA, COB and LI series.

Standard sizes are in bold.

ALSO SEE OUR "BUILD A BUMPER" CONFIGURATION TOOL ON OUR WEBSITE

AUTOCAR BUMPERS

AVAILABLE STYLES FOR PRODUCTS ON THIS PAGE:

AA, AB		End Style Code		AA, AB		End Style Code		KB		End Style Code				
 <p>TAPER ROLLED END</p>	Width	16"	02	 <p>SQUARE ROLLED END</p>	Width	16"	05	 <p>WRAP AROUND</p>	Width	12"	Bumper Length	94"	End Style Code	22
	18"	03	18"		06	12"	88"			22-88"				
	20"	31	20"		41									
	22"	32	22"		42									

AA

AUTOCAR
WITH 2" BREAKBACK
NOT AVAILABLE IN 12" WIDTH

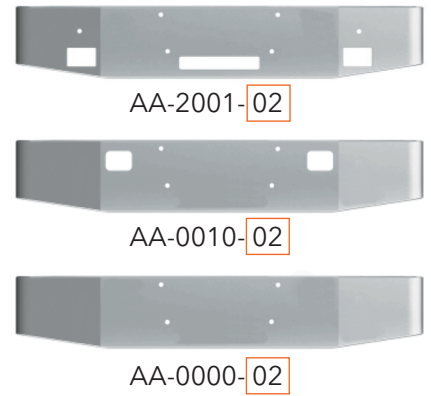
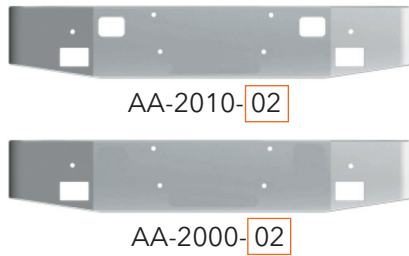
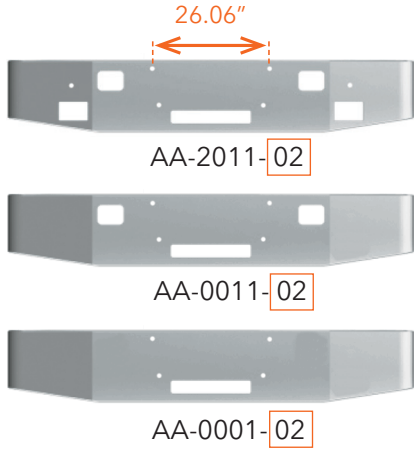

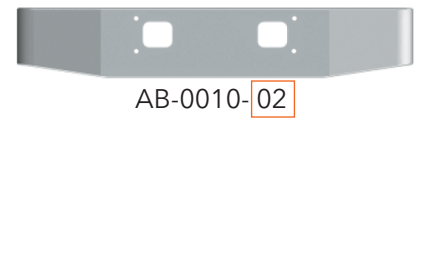
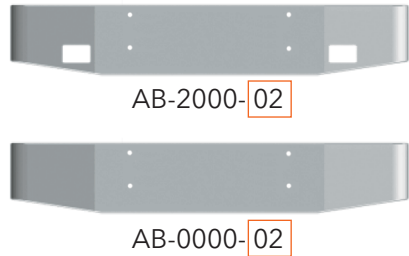
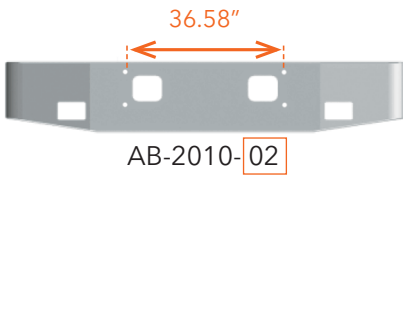

AB

AUTOCAR
WITH 2" BREAKBACK

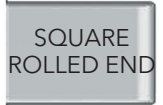

FORD BUMPERS

AVAILABLE STYLES FOR PRODUCTS ON THIS PAGE:

BA	Width	End Style Code	BA	Width	End Style Code	BF, BG	Width	End Style Code
 TAPER ROLLED END	12"	01	 SQUARE ROLLED END	10"	00	 SETBACK AXLE	9"	29
	16"	02		12"	04		12"	15
	18"	03		16"	05		16"	16
	20"	31		18"	06		*18"	17
	22"	32		20"	41			
			22"	42				

* No warranty for 18" width on models BF & BG

L, LN, LT, LTN, LTL -800-900-8000-9000 YEARS 1970-1998

ALSO MODELS LN7000 & STERLING LT9511

MUST BE 16" WIDE OR LARGER FOR 4 FOG LIGHT OPTION

BA



BA-4010-02

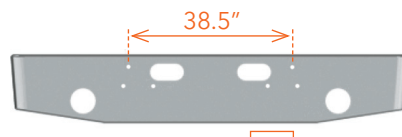

BA-1010-02



BA-4000-02

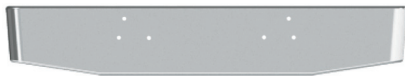

BA-0000-02



BA-1000-02



BA-0010-02

AEROMAX SETBACK AXLE - L, LS, LA, LTS, LTA YEARS 1988-1995

CHECK 'BG' SERIES PRIOR TO ORDERING

BF



BF-0000-29



BF-0010-29

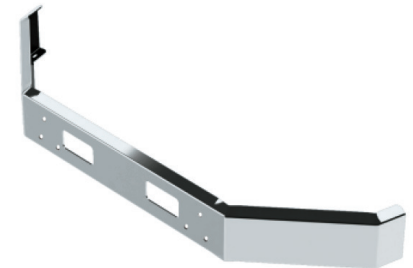

LST SET BACK AXLE YEARS 1988-1995

CHECK 'BF' SERIES PRIOR TO ORDERING

BG



BG-0000-29



BG-0010-29

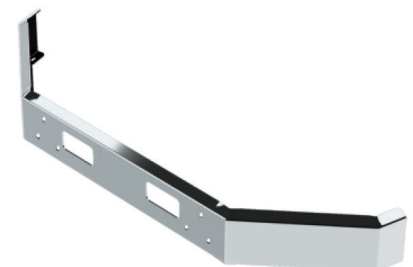

FORD BUMPERS

AVAILABLE STYLES FOR PRODUCTS ON THIS PAGE:



Width
13"
16"
18"
*20"

End Style
Code

15
16
17
34

* No warranty for 20" width

BI

F-650 SUPER DUTY YEARS 2005-2018

WITH CUMMINS 5.9L ENGINES

MOUNTING BRACKETS INCLUDED

CHECK 'BJ' SERIES PRIOR TO ORDERING

NOTE LETTERS 'BI' IN PART NUMBER

7.62"



BI-0011-15

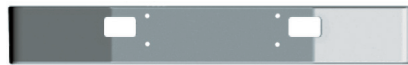

BI-0010-15



BI-0001-15



BI-0000-15



BI-0011-15

BJ

F-650 SUPER DUTY YEARS 2005-2018

WITH CATERPILLAR C7 ENGINES

MOUNTING BRACKETS INCLUDED

CHECK 'BI' SERIES PRIOR TO ORDERING

14.25"



BJ-0011-15

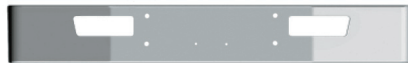

BJ-0010-15



BJ-0001-15



BJ-0000-15

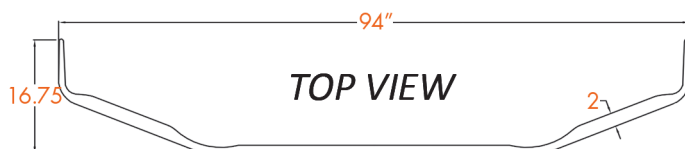

BJ-0011-15

FREIGHTLINER BUMPERS

EXAMPLE STYLES FOR PRODUCTS ON THIS PAGE:

Width	End Style Code	Width	End Style Code	Width	End Style Code
12"	01	12"	09	12"	04
16"	02	16"	10	16"	05
18"	03	18"	11	18"	06
20"	31	20"	51	20"	41
22"	32	22"	52	22"	42

CABOVER AND CONVENTIONAL

YEARS 1980-1984

CA



CA-1110-02



CA-1100-02



CA-1010-02



CA-0110-02



CA-1000-02



CA-0100-02



CA-0010-02



CA-0000-02

CABOVER AND CONVENTIONAL AND CLASSIC

YEARS 1984-1999

CB

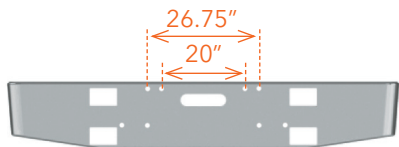

CB-2110-02



CB-2100-02



CB-2010-02



CB-0110-02



CB-2000-02



CB-0100-02



CB-0010-02

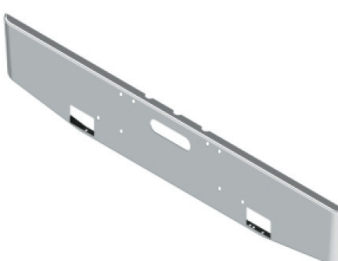

CB-0000-02



VF120009

FL-TOW PIN COVER -CLASSIC
FITS 'CA' & 'CB' SERIES BUMPERS



CB-2010-02

FREIGHTLINER BUMPERS

EXAMPLE STYLES FOR PRODUCTS ON THIS PAGE:

End Style	Width	End Style Code	End Style	Width	End Style Code	End Style	Width	End Style Code
TAPER ROLLED END	12"	01	BOXED END	12"	09	SQUARE ROLLED END	12"	04
	16"	02		16"	10		16"	05
	18"	03		18"	11		18"	06
	20"	31		20"	51		20"	41
	22"	32		22"	52		22"	42

CQ

26.75"
20"

FLD CLASSIC YEARS 2000-2002



CQ-2110-02



CQ-2100-02



CQ-2010-02



CQ-0110-02



CQ-2000-02

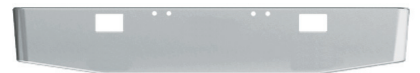

CQ-0100-02



CQ-0010-02



CQ-2010-02

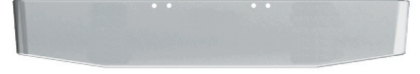

CQ-0000-02

CS

28.12"

FLD CLASSIC - 1200 SERIES YEARS 2002-2007



CS-2110-02



CS-2100-02



CS-2010-02



CS-0110-02



CS-2000-02



CS-0100-02



CS-0010-02



VF120009
FL-TOW PIN COVER - CLASSIC
FITS 'CQ' & 'CS' & 'CU' SERIES BUMPERS



CS-0000-02

CU

26.5"
18.88"

FLD CLASSIC - 1400 SERIES YEARS 2002-2007

ALSO CHECK 'CV' SERIES



CU-2110-02

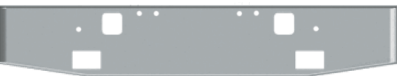

CU-2100-02



CU-2010-02



CU-0110-02



CU-2000-02



CU-0100-02



CU-0010-02



CU-2110-02



CU-0000-02

5.13"

FREIGHTLINER BUMPERS

EXAMPLE STYLES FOR PRODUCTS ON THIS PAGE:

Width	End Style Code	Width	End Style Code	Width	End Style Code
12"	01	12"	09	12"	04
16"	02	16"	10	16"	05
18"	03	18"	11	18"	06
20"	31	20"	51	20"	41
22"	32	22"	52	22"	42

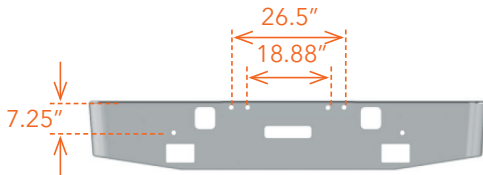

FLD CLASSIC YEARS 2002-2007 ALSO CHECK 'CU' SERIES

CV

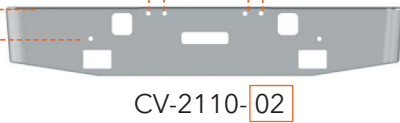

CV-2110-02

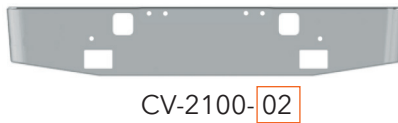

CV-2100-02



CV-2100-02



CV-0110-02



CV-2000-02

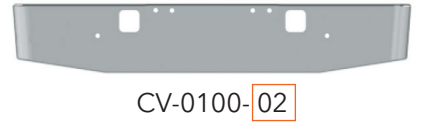

CV-0100-02

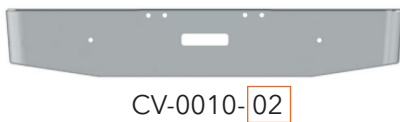

CV-0010-02



CV-2110-02



CV-0000-02



FLD CLASSIC YEARS 2008-2010 ONLY AVAILABLE IN 16" AND WIDER

CX

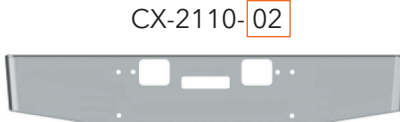

CX-2110-02

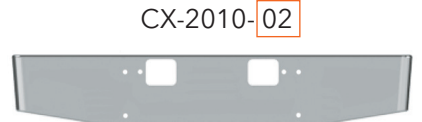

CX-2100-02

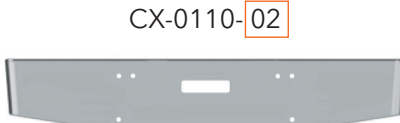

CX-0110-02

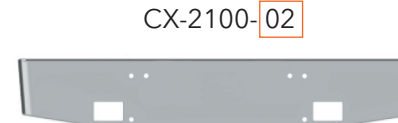

CX-2100-02

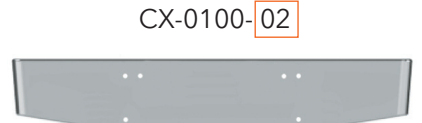

CX-0100-02

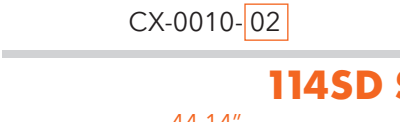

CX-0010-02



CX-2000-02

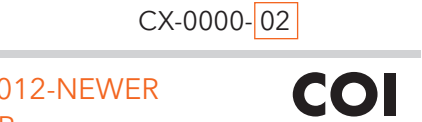

CX-0000-02

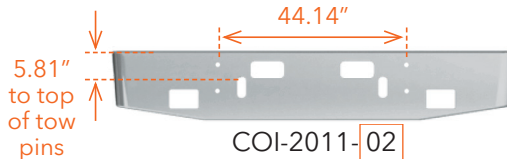

114SD SET FORWARD AXLE YEARS 2012-NEWER NOTE LETTERS "COI" IN PART NUMBER

COI



COI-2111-02



COI-2100-02



COI-2001-02



COI-0011-02



COI-2000-02

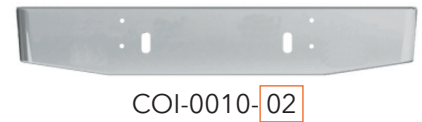

COI-0010-02



COI-0001-02



COI-0011-02

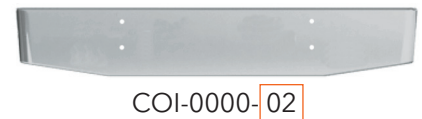

COI-0000-02

FREIGHTLINER BUMPERS

AVAILABLE STYLES FOR PRODUCTS ON THIS PAGE:

CZ			End Style Code			Width			End Style Code		
<p>GULLWING Width 19"</p>	End Style Code	707	<p>TAPER ROLLED END Width 12"</p>	End Style Code	01	<p>SQUARE ROLLED END Width 12"</p>	End Style Code	04			
					02			05			
					03			06			
					31			41			
					32			42			

CZ

CORONADO YEARS 2002-2009 & GLIDER CHASSIS
DOES NOT USE FACTORY SUPPORT BRACKETS OR ENDS CAPS



COC

CORONADO 122SD SET FORWARD YEARS 2010-NEWER
16" AND WIDER (SEE 'COE' SERIES FOR 12" BUMPERS)
NOTE LETTERS "COC" IN PART NUMBER

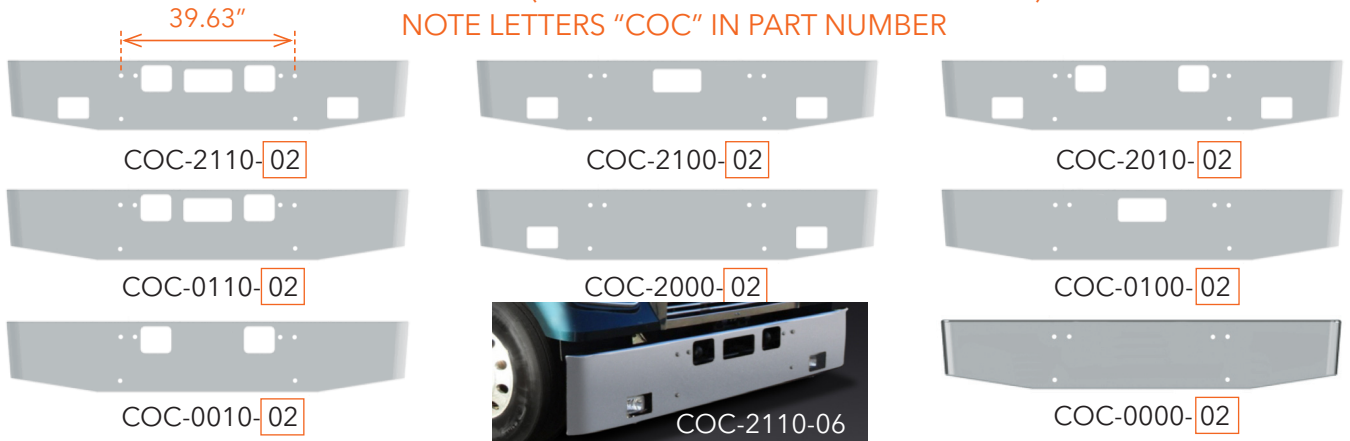

COE

CORONADO 122SD SET FORWARD YEARS 2010-NEWER
12" WIDE (SEE 'COC' SERIES FOR 16" AND WIDER BUMPERS)
NOTE LETTERS "COE" IN PART NUMBER



FREIGHTLINER BUMPERS

AVAILABLE STYLES FOR PRODUCTS ON THIS PAGE:



Width	End Style Code
12"	04
16"	95
18"	96
20"	97

* No warranty for 20" width

FLC112 SETBACK AXLE YEARS 1986-1995

CC

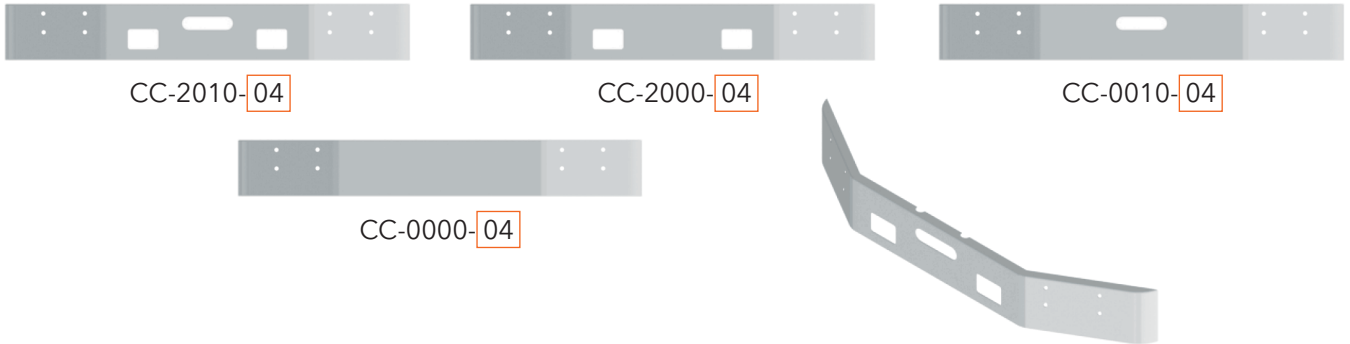

FLC120 SETBACK AXLE YEARS 1986-1995

CD

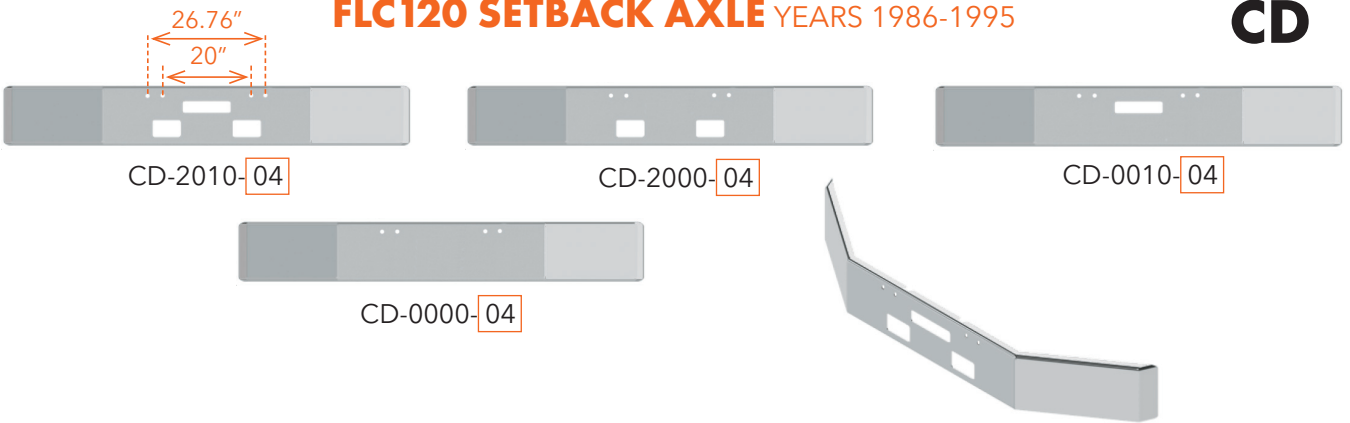

FLD 112SD SETBACK AXLE YEARS 1989-1996

CP

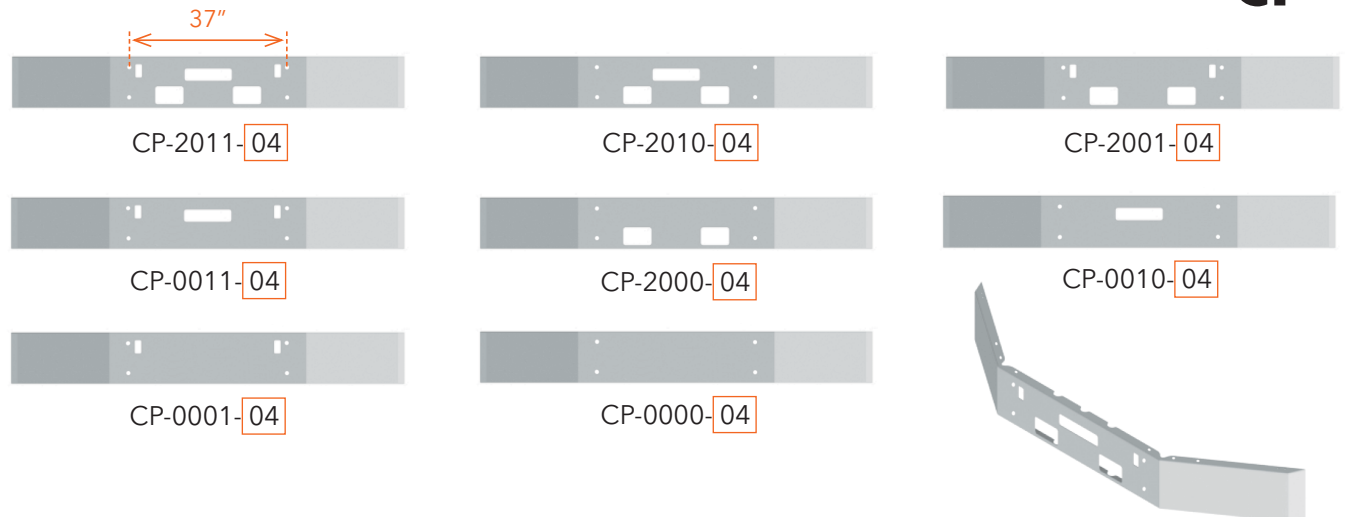

FREIGHTLINER BUMPERS



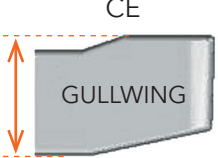
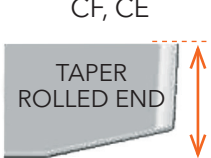
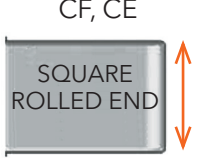













AVAILABLE STYLES FOR PRODUCTS ON THIS PAGE:

CE		CF, CE		End Style Code		CF, CE		End Style Code
	Width 16"		Width				Width	
	End Style Code 07		12"	01			12"	04
			16"	02			16"	05
			18"	03			18"	06
			20"	31			20"	41
			22"	32			22"	42

CF

CABOVER WITH 7 INCH BREAKBACK, YEARS 1989-1995

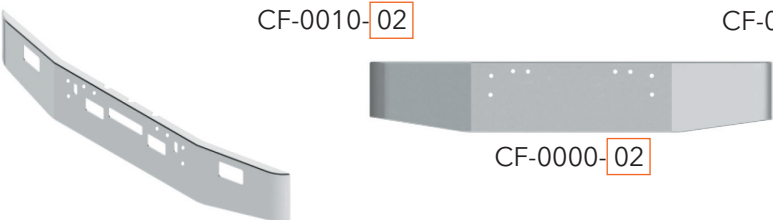
36.88"

		
CF-2111-02	CF-2110-02	CF-2101-02
		
CF-2011-02	CF-0111-02	CF-2100-02
		
CF-2010-02	CF-2001-02	CF-0110-02
		
CF-0101-02	CF-0011-02	CF-2000-02
		
CF-0100-02	CF-0010-02	CF-0001-02
		
	CF-0000-02	

CE

FLC112 CONVENTIONAL, YEARS 1986-1995
STEEL CAB MUST USE GULLWING STYLE -07 ONLY

22.75"

		
CE-1110-07	CE-1100-07	CE-1010-07
		
CE-0110-07	CE-1000-07	CE-0100-07
		
CE-0010-07	CE-2110-07	CE-0000-07

FREIGHTLINER BUMPERS

AVAILABLE STYLES FOR PRODUCTS ON THIS PAGE:

SQUARE ROLLED END	Width	End Style
		Code
	12"	04
	16"	95
	18"	96
	20"	97

* No warranty for 20" width

FOR 92-INCH LONG BUMPERS WITHOUT PLASTIC END CAPS, ADD "92" TO END OF PART NUMBER.
EXAMPLE: CG-2011-04-"92"

FLD112 WITH 6 INCH BREAKBACK, YEARS 1989-1996
86.75" LONG STANDARD. PLASTIC ENDS NOT INCLUDED.

CG

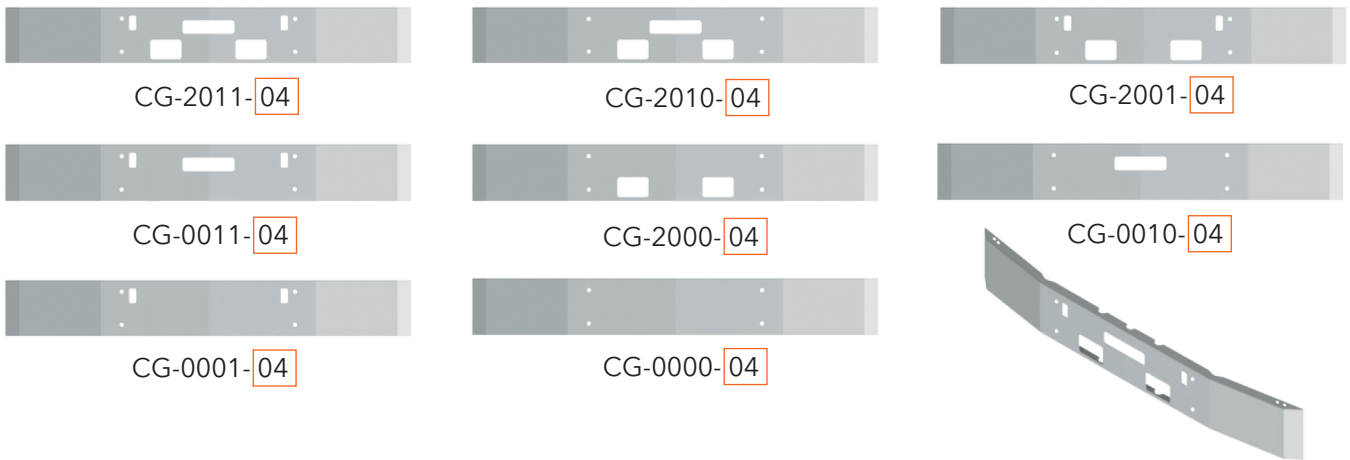

FLD120 WITH 6 INCH BREAKBACK, YEARS 1989-1996
86.75" LONG STANDARD. PLASTIC ENDS NOT INCLUDED (ALSO SEE 'CJ' SERIES).

CH

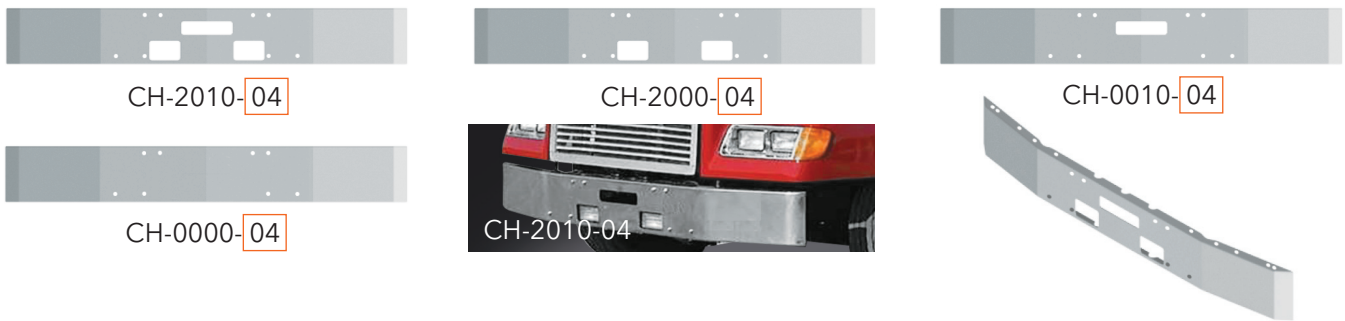

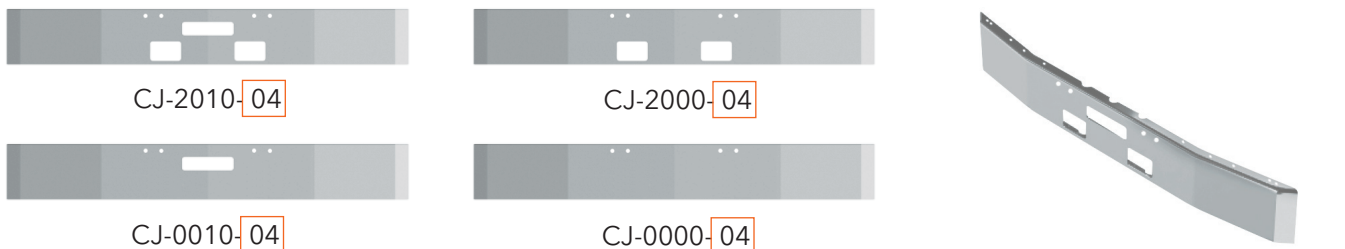

FLD120 WITH 6 INCH BREAKBACK, YEARS 1989-1996
86.75" LONG STANDARD. PLASTIC ENDS NOT INCLUDED (ALSO SEE 'CH' SERIES).

CJ

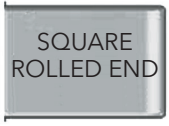

FREIGHTLINER BUMPERS

AVAILABLE STYLES FOR PRODUCTS ON THIS PAGE:

CM	Width	End Style Code	CI	Width	End Style Code
	12"	04		12"	15
	16"	95		16"	16
	18"	96		18"	17
	20"	97		*20"	34

* No warranty for 20" width

FOR 92 INCH LONG CM SERIES BUMPERS WITHOUT PLASTIC END CAPS, ADD "92" TO END OF PART NUMBER . EXAMPLE : CM-2011-04-"92"

CM

FLD 112 & FLD 120 WITH 6-INCH BREAKBACK, YEARS 1989-1996
86.75" LONG STANDARD. PLASTIC ENDS NOT INCLUDED.
COMBO BOLT PATTERN

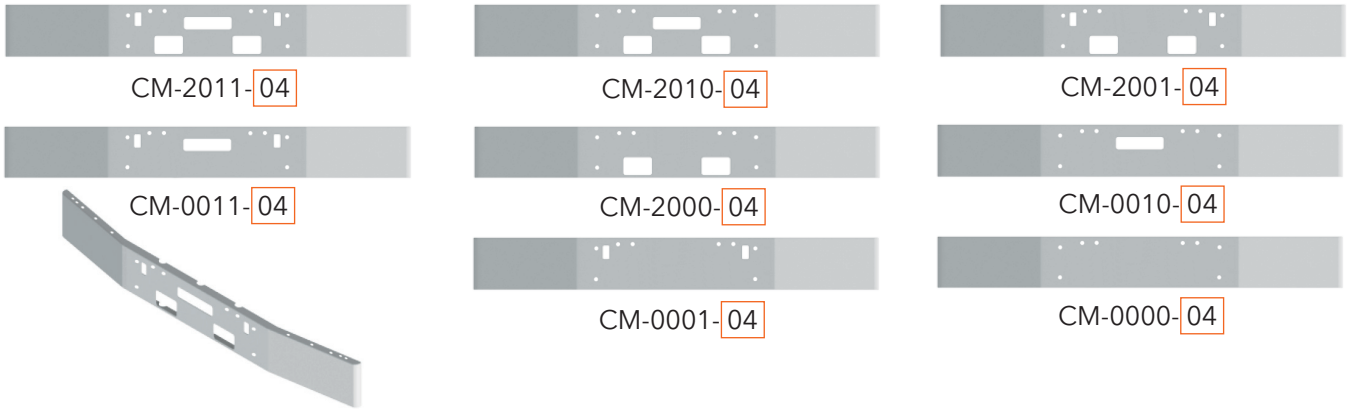

CI

FLD 112 & FLD 120 SETBACK FULL WRAP. METAL BUMPER, YEARS 1989-2006
COMBO BOLT PATTERN, NOTE LETTERS 'CI' IN PART NUMBER

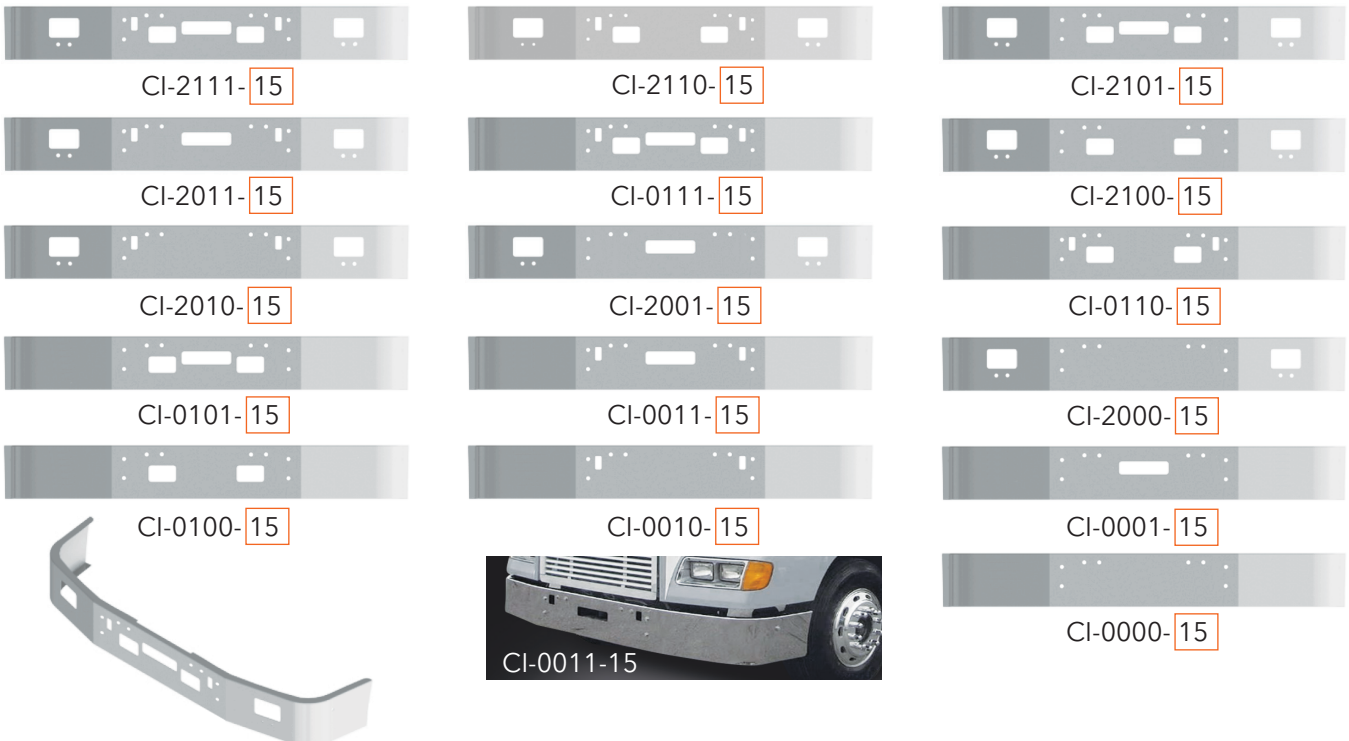

FREIGHTLINER BUMPERS

AVAILABLE STYLES FOR PRODUCTS ON THIS PAGE:



Width	End Style Code
14"	15
16"	16
18"	17
*20"	34

* No warranty for 20" width

CENTURY SETBACK AXLE, YEARS 1996-2004 MOUNTING BRACKETS INCLUDED

CL



CL-2210-15 CL-2200-15 CL-2010-15



CL-0210-15 CL-0200-15

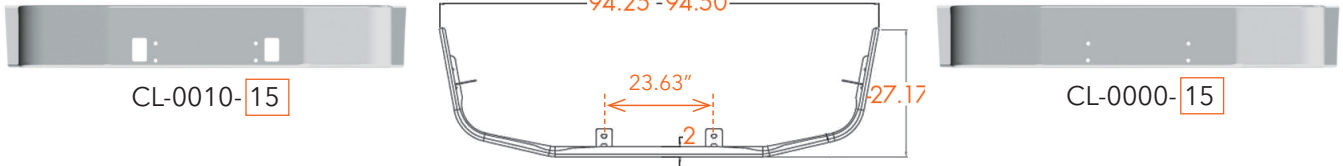

CL-0010-15 CL-0000-15

COLUMBIA SETBACK AXLE, YEARS 1999-2007

CW

CENTURY SETBACK AXLE, YEARS 2005-2007 MOUNTING BRACKETS INCLUDED

ALSO FITS NEWER MODEL GLIDERS - CHECK CHASSIS CONFIGURATION



CW-1011-15 CW-2011-15 CW-0011-15

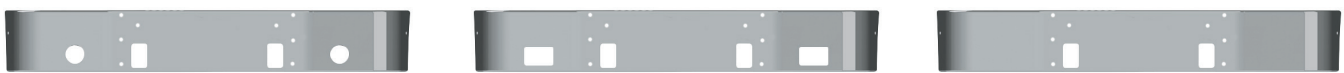

CW-1010-15 CW-2010-15 CW-0010-15



CW-0000-15 CW-2000-15 CW-0001-15



CW-0011-15

FREIGHTLINER BUMPERS

AVAILABLE STYLES FOR PRODUCTS ON THIS PAGE:



Width	End Style Code
18"	17
*20"	34

* No warranty for 20" width

COA

COLUMBIA SETBACK AXLE, YEARS 2008 & NEWER
REPLACES STEEL CENTER/PLASTIC ENDS BUMPERS ONLY
 MOUNTING BRACKETS INCLUDED

NOTE LETTERS 'COA' IN PART NUMBER. FOR 2008 & NEWER GLIDERS SEE CW SERIES.



COA-1011-17



COA-2011-17



COA-0011-17



COA-1010-17



COA-2010-17



COA-0010-17



COA-0000-17



COA-2000-17



COA-0001-17

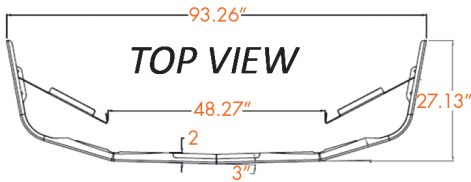

COB

COLUMBIA SETBACK AXLE, YEARS 2008 & NEWER

CENTURY SETBACK AXLE, YEARS 2008 & NEWER
REPLACES STAINLESS CLAD BUMPERS ONLY

MOUNTING BRACKETS INCLUDED. NOTE LETTERS 'COB' IN PART NUMBER.



COB-1011-17



COB-2011-17



COB-0011-17



COB-1010-17



COB-2010-17



COB-0010-17

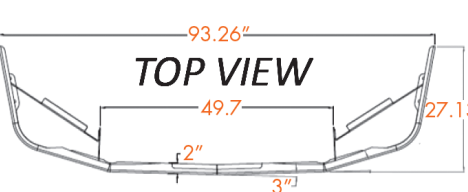

COB-0000-17



COB-0001-17

FREIGHTLINER BUMPERS

AVAILABLE STYLES FOR PRODUCTS ON THIS PAGE:

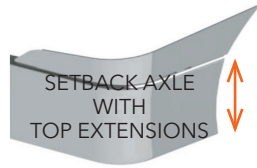

Width	End Style Code
14"	15X
16"	16X
18"	17X
*20"	34X

* No warranty for 20" width

CASCADIA "P3" YEARS 2008-2017



REPLACES PLASTIC BUMPERS ONLY

STANDARD WIDTH RADIATOR TRUCKS ONLY

MOUNTING BRACKETS AND EXTENSIONS INCLUDED

SEE 'COH' SERIES FOR REPLACING P3 STAINLESS CLAD

SEE 'COJ' AND 'COK' SERIES FOR NEWER P4 BUMPERS



CY-5010-15X
2 OEM fogs, tow pins



CY-2011-15X
2 rect. fogs, tow pins, vent
No radar



CY-5012-15X
2 OEM fogs, tow pins, vent
Accommodates radar



CY-0011-15X
Tow pins, vent, no radar



CY-0012-15X
Tow pins, vent
Accommodates radar



CY-0000-15X
No cutouts, mounting only

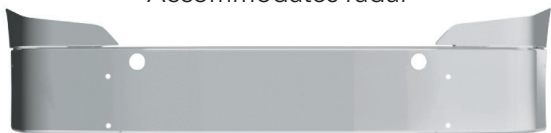

CY-0010-15X
Tow pins



CY-5011-15X

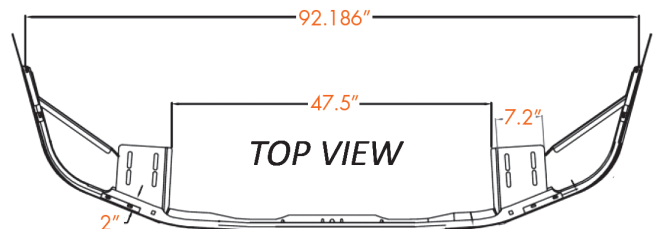

FREIGHTLINER BUMPERS

AVAILABLE STYLES FOR PRODUCTS ON THIS PAGE:

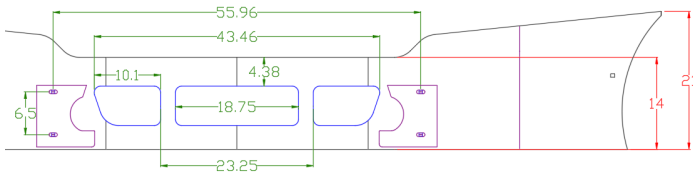

End Style Code

708S



ONE-PIECE BUMPER (ONE SIZE ONLY)

CASCADIA YEARS 2008-2017

REPLACES PLASTIC BUMPERS ONLY

STANDARD WIDTH RADIATOR TRUCKS ONLY

MOUNTING BRACKETS AND EXTENSIONS INCLUDED

SEE 'COH' SERIES FOR REPLACING P3 STAINLESS CLAD

SEE 'COJ' AND 'COK' SERIES FOR NEWER P4 BUMPERS

CY



CY-5011-708S

2 OEM fogs, tow pins, vent
No radar



CY-0001-708S

vent
No Radar



CY-0002-708S

vent
Accommodates Radar

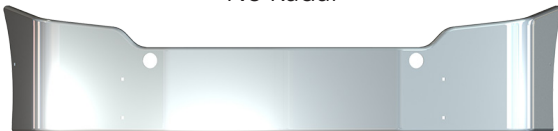

CY-0010-708S

tow pins



CY-0011-708S

tow pins, vent
No radar



CY-0012-708S

tow pins, vent
Accommodates Radar



CY-5012-708S

2 OEM fogs, tow pins, vent
Accommodates Radar



CY-5011-708S

2 OEM fogs, tow pins, vent
No radar

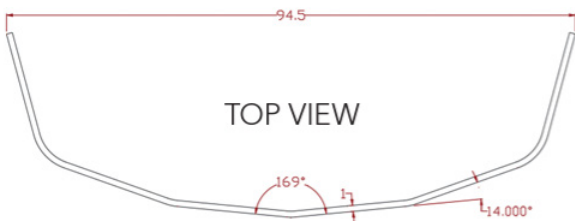

FREIGHTLINER BUMPERS

AVAILABLE STYLES FOR PRODUCTS ON THIS PAGE:

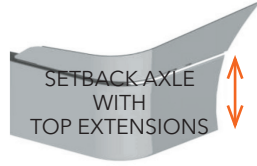

Width	End Style Code
14"	15X
*16"	16X

* 16" bumpers require customer to shim brackets

COH

CASCADIA "P3" YEARS 2008-2017

REPLACES STAINLESS CLAD BUMPERS ONLY

STANDARD WIDTH RADIATOR TRUCKS ONLY

EXTENSIONS INCLUDED, MOUNTING BRACKETS NOT INCLUDED

MOUNTS TO EXISTING CLAD BUMPER BRACKETS

SEE 'CY' SERIES FOR REPLACING P3 PLASTIC BUMPERS

SEE 'COJ' AND 'COK' SERIES FOR NEWER P4 BUMPERS

NOTE LETTERS 'COH' IN PART NUMBER



COH-5011-15X
2 OEM fogs, tow pins, vent
No radar



COH-5012-15X
2 OEM fogs, tow pins, vent
Accommodates radar

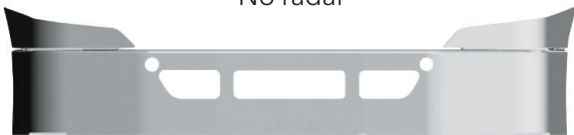

COH-0011-15X
Tow pins, vent, no radar

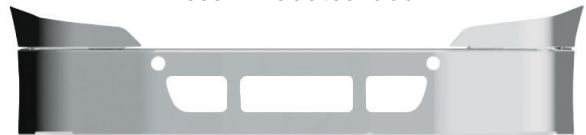

COH-0012-15X
Tow pins, vent
Accommodates radar



COH-0000-15X
No cutouts, mounting only



COH-0010-15X
Tow pins

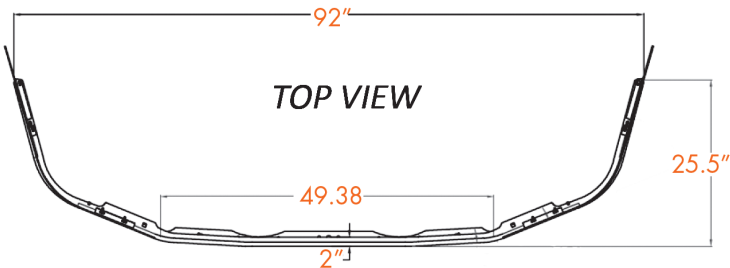

FREIGHTLINER BUMPERS

AVAILABLE STYLES FOR PRODUCTS ON THIS PAGE:

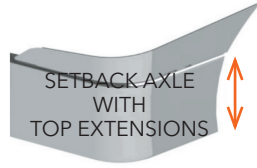

Width	End Style Code
14"	15Z
16"	16Z
18"	17Z
*20"	34Z

* No warranty for 20" wide bumpers

CASCADIA "P4" YEARS 2017 & NEWER
 REPLACES PLASTIC BUMPERS ONLY
 STANDARD WIDTH RADIATOR TRUCKS ONLY
 MOUNTING BRACKETS INCLUDED
 NOTE LETTERS 'COJ' IN PART NUMBER
 SEE 'COK' SERIES IF REPLACING STAINLESS CLAD BUMPERS

COJ



COJ-5011-15Z-V6
 2 OEM fogs, tow pins, vent, radar
 Radar requires plastic cover

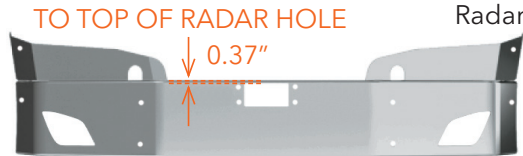

COJ-5010-15Z-V6
 2 OEM fogs, tow pins, radar
 Radar requires plastic cover



COJ-2010-15Z-V6
 2 rectangular aftermarket fogs, tow pins, radar
 Radar requires plastic cover



COJ-5010-15Z
 2 OEM fogs, tow pins

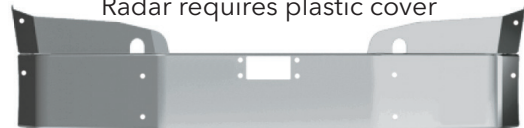

COJ-0010-15Z-V6
 Tow pins, radar
 Radar requires plastic cover



COJ-0011-15Z
 Tow pins, vent

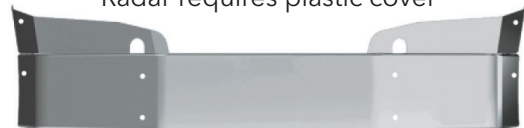

COJ-0010-15Z
 Tow pins



COJ-5011-15Z-V6

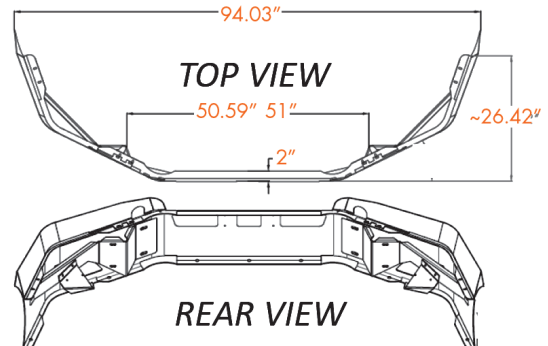

FREIGHTLINER BUMPERS

AVAILABLE STYLES FOR PRODUCTS ON THIS PAGE:

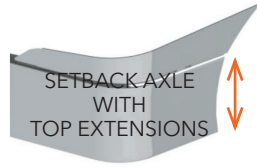

Width	End Style Code
14"	15Z
16"	16Z
18"	17Z
*20"	34Z

* No warranty for 20" wide bumpers

COK

CASCADIA "P4" YEARS 2017 & NEWER
 REPLACES STAINLESS CLAD BUMPERS ONLY
 STANDARD WIDTH RADIATOR TRUCKS ONLY
 MOUNTING BRACKETS INCLUDED
 NOTE LETTERS 'COK' IN PART NUMBER
 SEE 'COJ' SERIES IF REPLACING PLASTIC BUMPERS



COK-5011-15Z-V6
 2 OEM fogs, tow pins, vent, radar
 Radar requires plastic cover

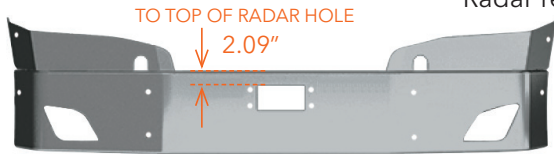

COK-5010-15Z-V6
 2 OEM fogs, tow pins, radar
 Radar requires plastic cover



COK-2010-15Z-V6
 2 rectangular aftermarket fogs, tow pins, radar
 Radar requires plastic cover

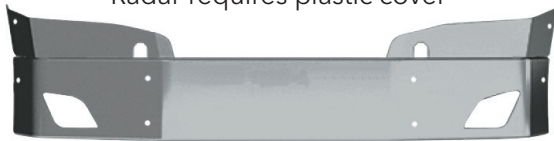

COK-5010-15Z
 2 OEM fogs, tow pins

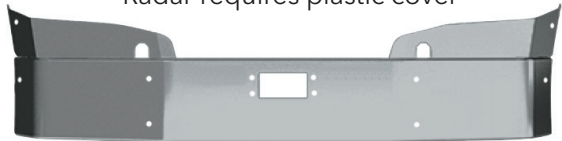

COK-0010-15Z-V6
 Tow pins, radar
 Radar requires plastic cover



COK-0011-15Z
 Tow pins, vent

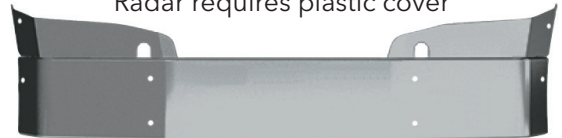

COK-0010-15Z
 Tow pins



COK-5011-15Z-V6

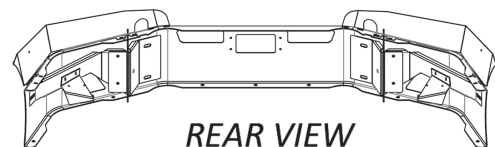
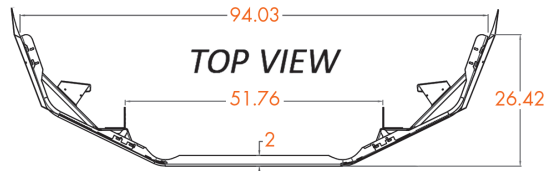

FREIGHTLINER BUMPERS

AVAILABLE STYLES FOR PRODUCTS ON THIS PAGE:



Width	End Style Code
12"	15
16"	16
18"	17
*20"	34

*No warranty for 20" wide bumpers

FL SERIES MEDIUM DUTY YEARS 2002 & OLDER

CK

FL50, FL60, FL70, FL80
MOUNTS TO FACTORY BRACKETS
ALSO CHECK 'CR' SERIES



CK-0220-15



CK-0020-15



CK-0200-15

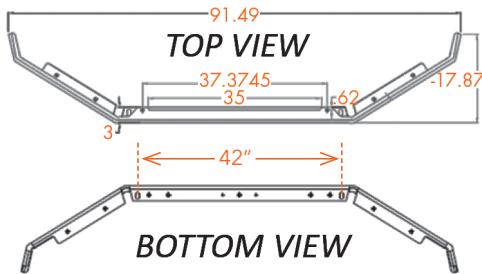

CK-0000-15

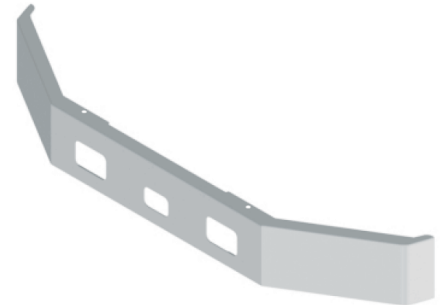
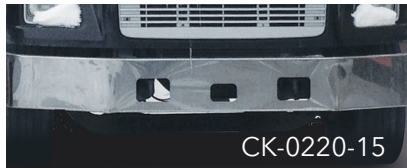

FL112 SERIES MEDIUM DUTY YEARS 2002 & OLDER

CR

MOUNTS TO FACTORY BRACKETS
ALSO CHECK 'CK' SERIES



CR-0220-15



CR-0020-15



CR-0200-15

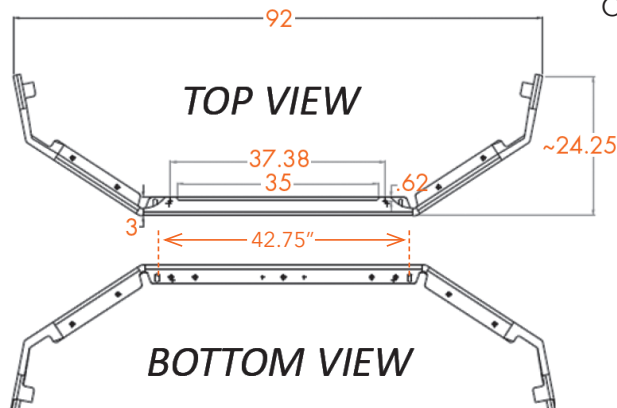

CR-0000-15

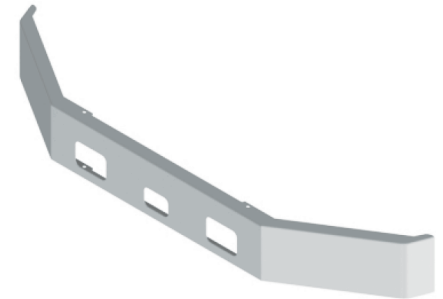

FREIGHTLINER BUMPERS

AVAILABLE STYLES FOR PRODUCTS ON THIS PAGE:



SETBACK AXLE

Width	End Style Code
13"	15
16"	16
18"	17
*20"	34

* No warranty for 20" wide bumpers

CT

M2 106 BUSINESS CLASS YEARS 2003 & NEWER
 FLUSH TOP FLANGE MOUNT. INCLUDES UPPER LICENSE PLATE HOLES.
 ALSO CHECK 'COG' SERIES

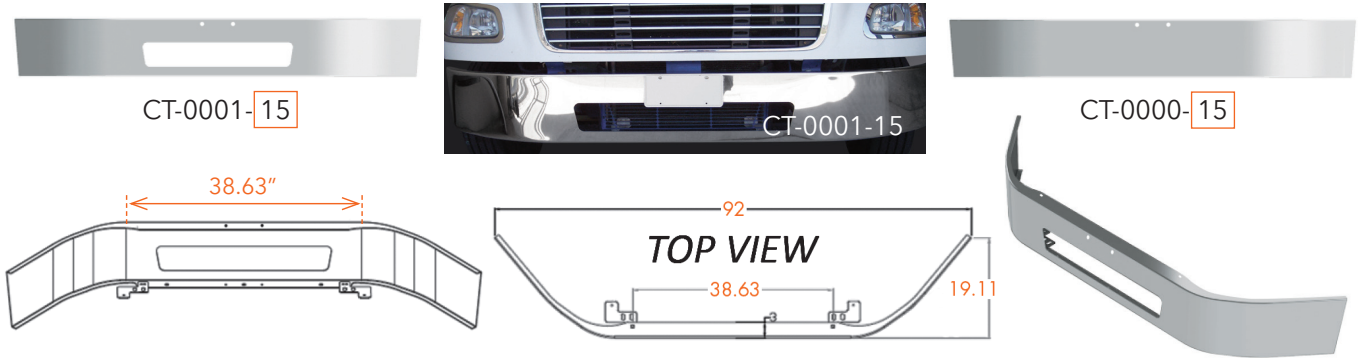

CT-0001-15

CT-0000-15

CT-0001-15

TOP VIEW

38.63

19.11

COF

M2 112 BUSINESS CLASS YEARS 2003 & NEWER
 TOP FLANGE MOUNT ON INTEGRATED GUSSETS. INCLUDES UPPER LICENSE PLATE HOLES.
 NOTE LETTERS 'COF' IN PART NUMBER



COF-0011-15

COF-0010-15

COF-0001-15

COF-0000-15

COF-0011-15

TOP VIEW

52.47

18.84

COG

M2 106 BUSINESS CLASS YEARS 2011 & NEWER
 RECESSED TOP FLANGE MOUNT, BRACKETS INCLUDED
 NOTE LETTERS 'COG' IN PART NUMBER
 CHECK 'CT' SERIES PRIOR TO ORDERING

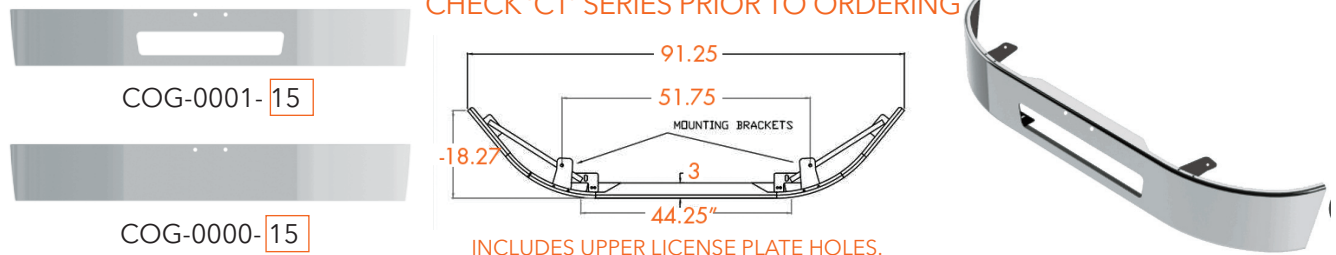

COG-0001-15

COG-0000-15

COG-0001-15

TOP VIEW

44.25

18.27

MOUNTING BRACKETS

INCLUDES UPPER LICENSE PLATE HOLES.

GMC BUMPERS

EXAMPLE STYLES FOR PRODUCTS ON THIS PAGE:

Width	End Style Code	Width	End Style Code	Width	End Style Code
12"	01	12"	09	12"	04
16"	02	16"	10	16"	05
18"	03	18"	11	18"	06
20"	31	20"	51	20"	41
22"	32	22"	52	22"	42

GENERAL YEARS 1977-1987 **DB**

DB-1001-02 DB-1000-02

DB-0001-02 DB-0000-02

BRIGADIER YEARS 1978-1988 **DC**

DC-1001-02 DC-1000-02

DC-0001-02 DC-0000-02

BRIGADIER HIGH CAB YEARS 1978-1988 **DD**

DD-1001-02 DD-1000-02

DD-0001-02 DD-0000-02

ASTRO YEARS 1982-1987, NOT AVAILABLE IN 12" WIDTH **DE**

DE-1011-02 DE-1010-02 DE-1001-02

DE-0011-02 DE-1000-02 DE-0010-02

DE-0001-02 DE-0000-02

GMC BUMPERS

AVAILABLE STYLES FOR PRODUCTS ON THIS PAGE:



DH

GMC 7000/CHEVY C60, C65, C70 YEARS 1981-1988

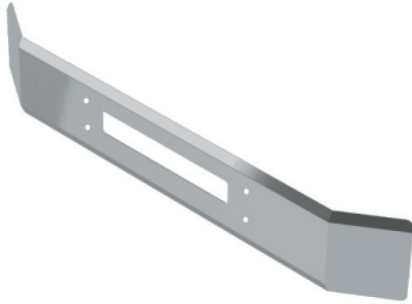

DH-0001-12



DH-0000-12

DF

GMC TOPKICK/CHEVY KODIAK YEARS 1989-1990
NOT AVAILABLE IN 7-GAUGE STEEL OR STAINLESS STEEL

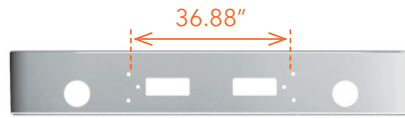
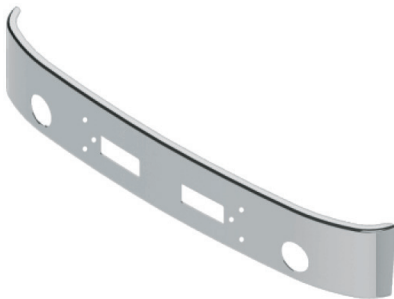

DF-1001-38



DF-1000-38



DF-0001-38



DF-0000-38

DG

GMC TOPKICK/CHEVY KODIAK YEARS 1990-2003
C5500, C6500
NOT AVAILABLE IN 7-GAUGE STEEL OR STAINLESS STEEL

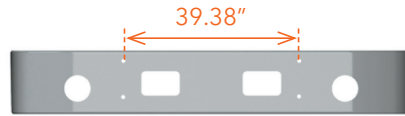
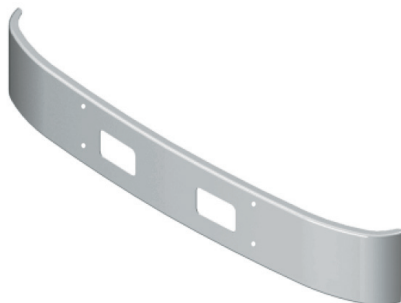

DG-1001-38



DG-1000-38



DG-0001-38



DG-0000-38

GMC BUMPERS

AVAILABLE STYLES FOR PRODUCTS ON THIS PAGE:



Width	End Style Code
14"	15
16"	16
18"	17

C4500, C5500 YEARS 2004-2006

NOTE LETTERS 'DI' IN PART NUMBER
INCLUDES UPPER LICENSE PLATE HOLES.

DI

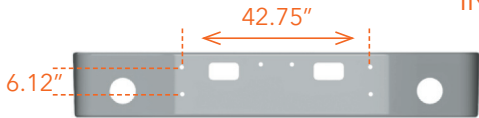

DI-1001-15



DI-0001-15



DI-1000-15



DI-0000-15

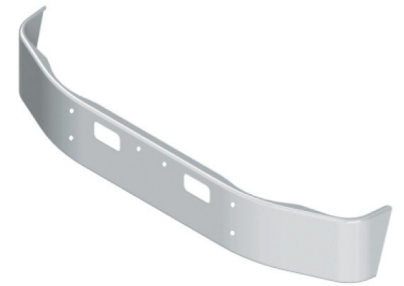

DI-0001-15

C6500, C7500 YEARS 2004-2009

INCLUDES UPPER LICENSE PLATE HOLES.

DJ

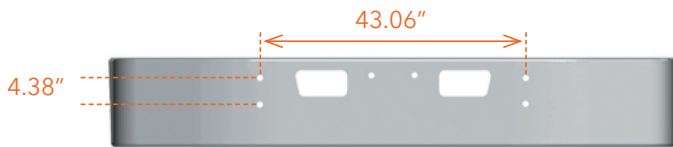

DJ-0001-15



DJ-0000-15

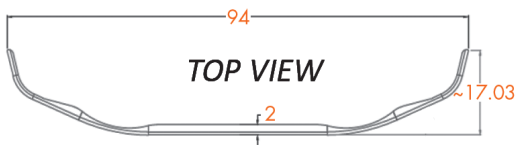

DJ-0001-15



HINO BUMPERS

AVAILABLE STYLES FOR PRODUCTS ON THIS PAGE:



Width	End Style Code
14"	15
16"	16
18"	17
*20"	34

* No warranty for 20" wide bumpers

OA

268, 338 YEARS 2004 & NEWER
MOUNTING BRACKETS INCLUDED
NOTE LETTERS 'OA' IN PART NUMBER
INCLUDES ONE SET UPPER LICENSE PLATE HOLES



OA-0011-15



OA-0010-15



OA-0001-15



OA-0000-15

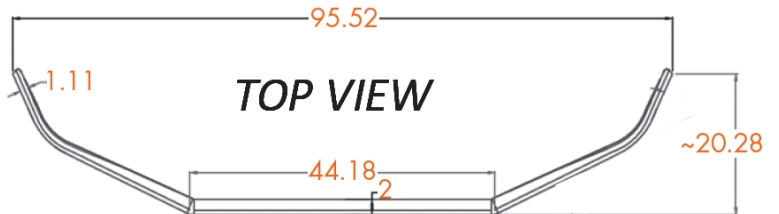

OA-0011-15



OA-0011-15P

Add "P" to end of any bumper part number for black powder coated steel

INTERNATIONAL BUMPERS

EXAMPLE STYLES FOR PRODUCTS ON THIS PAGE:

Width	End Style Code	Width	End Style Code	Width	End Style Code
12"	01	12"	09	12"	04
16"	02	16"	10	16"	05
18"	03	18"	11	18"	06
20"	31	20"	51	20"	41
22"	32	22"	52	22"	42

4200, 4300 YEARS YEARS 1977-1990 CONVENTIONAL

ED

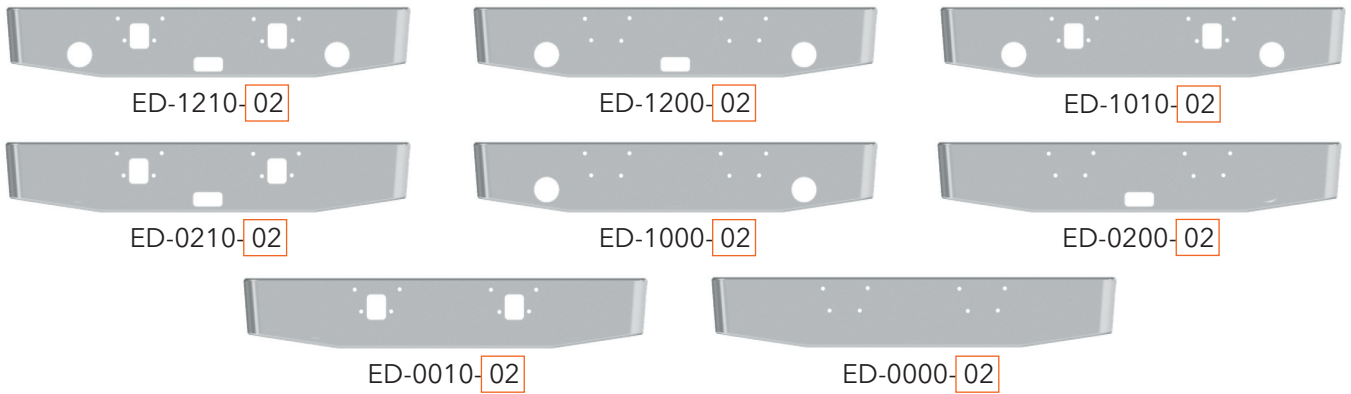

9300, 9370 CONVENTIONAL, 9670 CABOVER YEARS 1983-1996

EI

SET FORWARD AXLE. SEE 'EJ' SERIES FOR SETBACK AXLE.
NOTE LETTERS 'EI' IN PART NUMBER

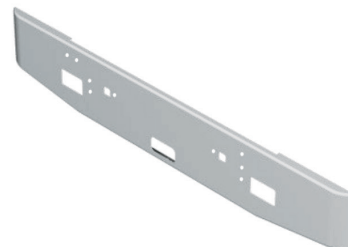
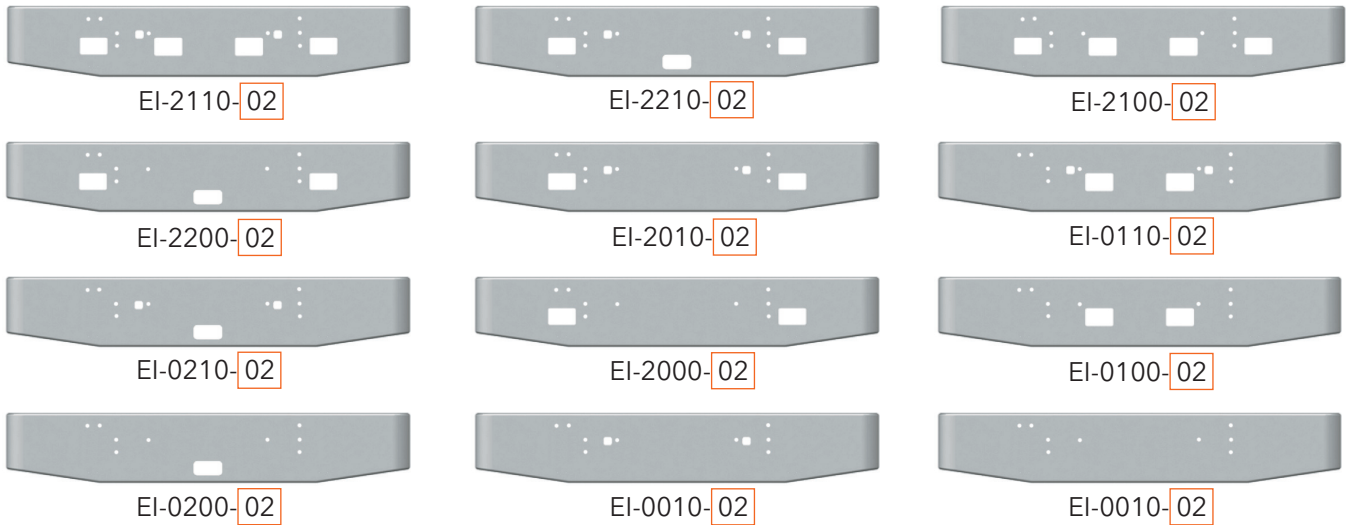

INTERNATIONAL BUMPERS

AVAILABLE STYLES FOR PRODUCTS ON THIS PAGE:

Width	End Style Code	Width	End Style Code
12"	04	12"	09
16"	05	16"	10
18"	96	18"	11
*20"	97	20"	51
*22"	98	22"	52

* No warranty for 20" wide bumpers

EJ

9300 SERIES SET BACK AXLE YEARS 1983-1996

SEE 'EI' SERIES FOR SET FORWARD AXLE



EJ-2210-96



EJ-2000-96



EJ-0010-96



EJ-0210-96



EJ-0200-96



EJ-0000-96



EJ-2010-96



EJ-2200-96



EJ-2210-96

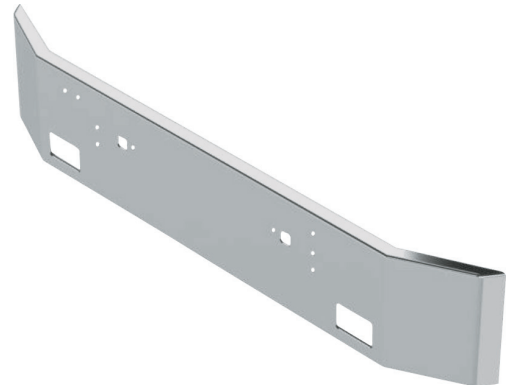

VC VALLEY CHROME PLATING





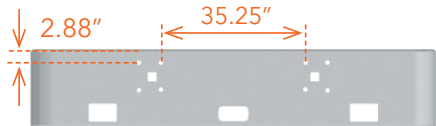

INTERNATIONAL BUMPERS

EXAMPLE STYLES FOR PRODUCTS ON THIS PAGE:

Width	End Style Code	Width	End Style Code	Width	End Style Code
12"	01	12"	09	12"	04
16"	02	16"	10	16"	05
18"	03	18"	11	18"	06
20"	31	20"	51	20"	41
22"	32	22"	52	22"	42

9900 YEARS 1998-1999 **EN**

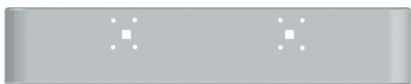
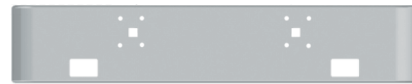
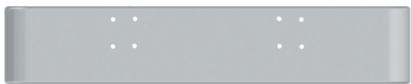

		
EN-2210-06	EN-2200-06	EN-0200-06
		
EN-2000-06	EN-0210-06	EN-0200-06
		
EN-0010-06	EN-2010-06	EN-0000-06

9900 YEARS 2000 & NEWER **ER**



		
ER-2210-06	ER-2200-06	ER-2010-06
		
ER-2000-06	ER-0210-06	ER-0200-06
		
ER-0010-06	ER-0000-06	ER-0000-06

5900 SET FORWARD AXLE YEARS 2001-2011 **EW**

		
EW-2010-02	EW-2020-02	EW-2030-02
		
EW-2000-02	EW-0010-02	EW-0020-02
		
EW-0030-02	EW-2010-02	EW-0000-02

INTERNATIONAL BUMPERS

AVAILABLE STYLES FOR PRODUCTS ON THIS PAGE:



EF

2200S, 2500S YEARS 1977-1990

NOT AVAILABLE IN 10-GAUGE STEEL OR STAINLESS STEEL



EF-1010-24



EF-1000-24



EF-0000-24



EF-0010-24

EG

1700S, 1800S 1900S YEARS 1977-1990

NOT AVAILABLE IN 10-GAUGE STEEL OR STAINLESS STEEL

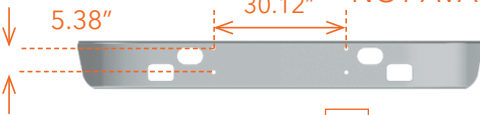

EG-2010-24

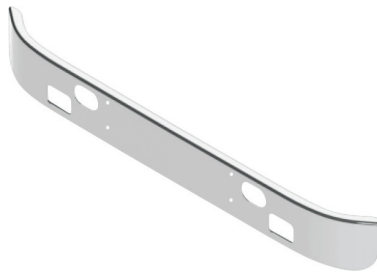

EG-2000-24

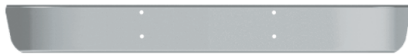

EG-0000-24

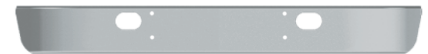

EG-0010-24

EL

4000 SERIES, 7000 SERIES, 8000 SERIES YEARS 1990-2004

NOT AVAILABLE IN 10-GAUGE STEEL OR STAINLESS STEEL

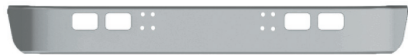

EL-2010-24

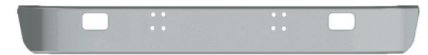

EL-2000-24

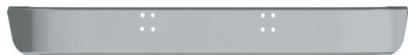

EL-0000-24



EL-0010-24

EM

4000 SERIES, 7000 SERIES, 8000 SERIES YEARS 1990-2004

NOT AVAILABLE IN 10-GAUGE STEEL OR STAINLESS STEEL



EM-2010-24



EM-2000-24



EM-0000-24



EM-0010-24

INTERNATIONAL BUMPERS

EXAMPLE STYLES FOR PRODUCTS ON THIS PAGE:



Width	End Style Code
13"	15
16"	16
18"	17
*20"	34

* No warranty for 20" wide bumpers

9400 SETBACK AXLE YEARS 1990-1996

CHECK 'ES' AND 'EP' SERIES PRIOR TO ORDERING

EK

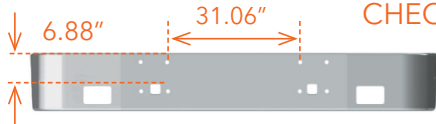

EK-2010-15



EK-2000-15



EK-0010-15



EK-0000-15

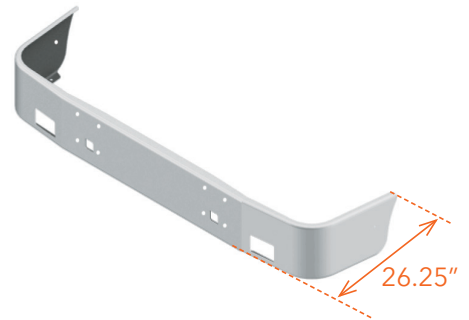

9200 SETBACK AXLE YEARS 1992-1996

CHECK 'EK' AND 'EP' SERIES PRIOR TO ORDERING

ES

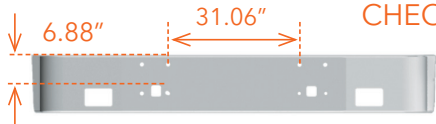

ES-2010-15



ES-2000-15



ES-0010-15



ES-0000-15

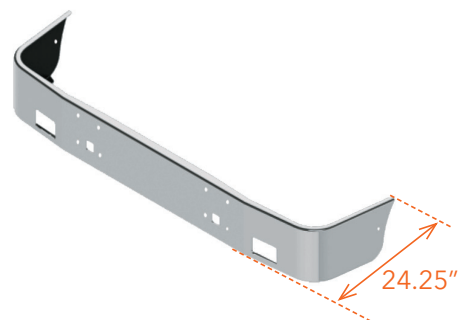

9100, 9200, 9400 SETBACK AXLE YEARS 1997-2007

CHECK 'EK' AND 'ES' SERIES PRIOR TO ORDERING

EP

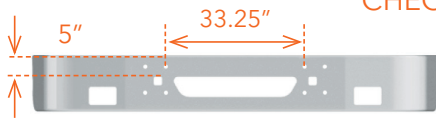

EP-2011-15



EP-2010-15



EP-0012-15 (radar)



EP-0011-15



EP-2000-15



EP-0010-15



EP-0001-15



EP-0011-15



EP-0000-15

INTERNATIONAL BUMPERS

AVAILABLE STYLES FOR PRODUCTS ON THIS PAGE:

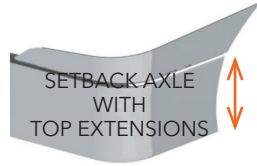

Width	End Style Code
16"	16X
18"	17X
*20"	34X

* No warranty for 20" wide bumpers

EU

PROSTAR YEARS 2008-2017
FIXED MOUNT / NON-TILT
MOUNTING BRACKETS AND EXTENSIONS INCLUDED



EU-5011-16X
2 OEM fogs, tow pins, vent



EU-5010-16X-V9
2 OEM fogs, tow pins, round radar
Use option - V8 for rectangular radar



EU-0011-16X
Tow pins, vent



EU-5010-16X
2 OEM fogs, tow pins



EU-0010-16X
Tow pins



EU-0000-16X
No cutouts, mounting only

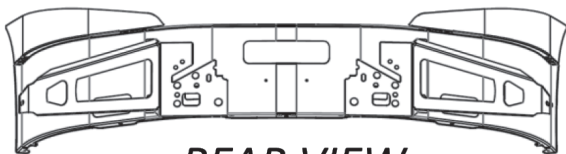

REAR VIEW

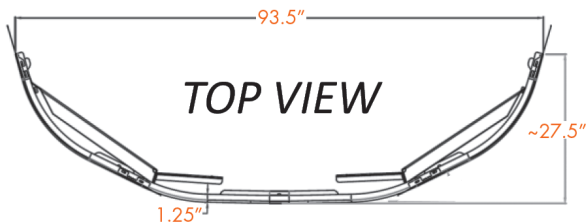

TOP VIEW



EU-5011-16X

INTERNATIONAL BUMPERS

AVAILABLE STYLES FOR PRODUCTS ON THIS PAGE:

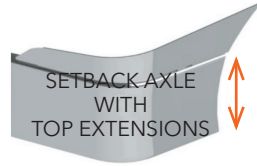

Width	End Style Code
16"	16X
18"	17X
*20"	34X

* No warranty for 20" wide bumpers

LT SERIES YEARS 2017 & NEWER
MOUNTING BRACKETS AND EXTENSIONS INCLUDED
REPLACES PLASTIC BUMPERS ONLY

EY



EY-5013-16X

2 OEM fogs, tow pins, slotted vent



EY-0010-16X

Tow pins



EY-2011-16X

2 rectangular fogs, tow pins, open vent



EY-0013-16X

Tow pins, slotted vent



EY-0000-16X

Mounting Only



EY-0011-16X

Tow pins, open vent

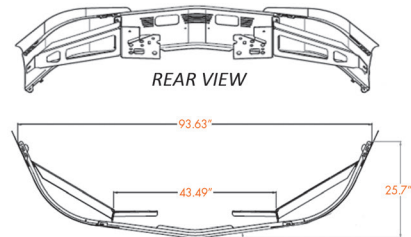

MV607 SETBACK AXLE YEARS 2024 & NEWER
(-15) END STYLE FOR THIS SERIES IS 14"

EZ



12 to 14"	15
16"	16
18"	17
20"*	34

* No warranty for 20" wide bumpers

Factory Fog Light Mounting Holes



EZ-0011-15

Tow, Vent

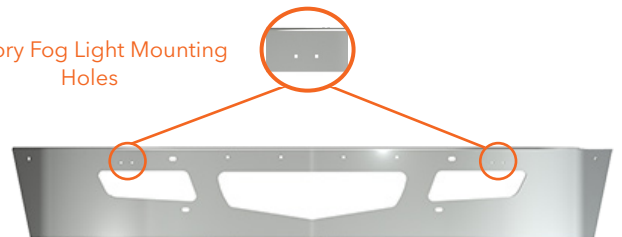

EZ-5011-15

Fog, Tow, Vent



SHOWN WITH FACTORY GRILL INSERT
(GRILL INSERT NOT INCLUDED)

INTERNATIONAL BUMPERS

AVAILABLE STYLES FOR PRODUCTS ON THIS PAGE:



FACTORY
STYLE

Width
14"

**End Style
Code**
38

10 GAUGE ONLY



SETBACK
AXLE

Width
13"
16"
18"
*20"

End Style Code	
15	
16	
17	
34	

* No warranty for
20" wide bumpers

ET 4000 SERIES MEDIUM DUTY / DURASTAR YEARS 2002 & NEWER

AUTOMATIC MUST INCLUDE VENT HOLE
ADAPTER BRACKETS INCLUDED



ET-0011-15



ET-0010-15



ET-0001-15



ET-0021-15

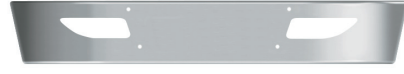

ET-0020-15



ET-0021-15

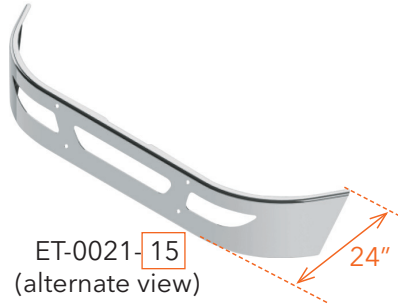

ET-0021-15
(alternate view) 24"

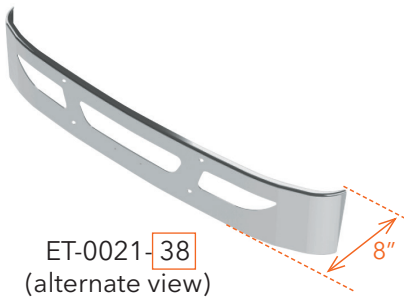

ET-0021-38
(alternate view) 8"

EV 7000 SERIES MEDIUM DUTY / WORKSTAR YEARS 2006 & NEWER

AUTOMATIC MUST INCLUDE VENT HOLE
INCLUDES ONE SET LICENSE PLATE HOLES



EV-5001-38



EV-0001-38



EV-5001-38



EV-5000-38



EV-0000-38

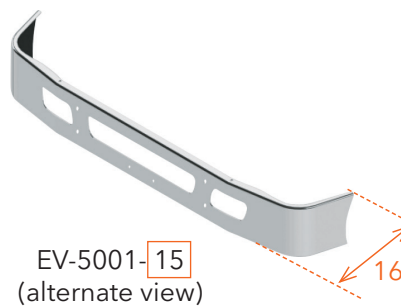



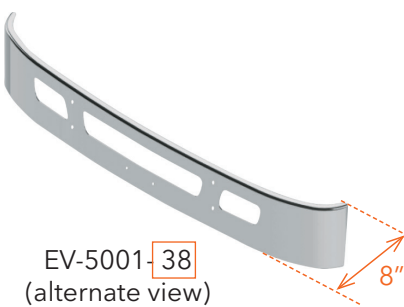

EV-5001-15
(alternate view) 16"



EV-5001-38
(alternate view) 8"

KENWORTH BUMPERS

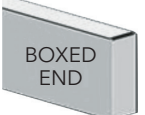
EXAMPLE STYLES FOR PRODUCTS ON THIS PAGE:







 <p>TAPER ROLLED END</p>	Width	End Style Code	 <p>GULLWING</p>	 <p>BOXED END</p>	 <p>SQUARE ROLLED END</p>
	12"	01			
	16"	02			
	18"	03			
	20"	31			
22"	32				
	Width	End Style Code			
	16"	07			

Width	End Style Code
12"	09
16"	10
18"	11
20"	51
22"	52

Width	End Style Code
12"	04
16"	05
18"	06
20"	41
22"	42



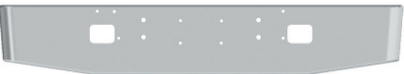

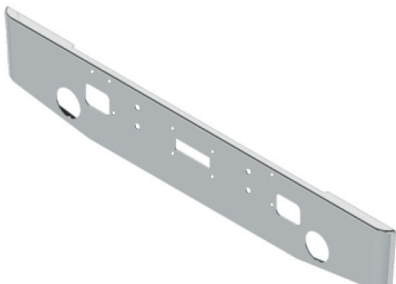
K100C CABOVER YEARS 1967-1983

FA

		
FA-1110-02	FA-1100-02	FA-1010-02
		
FA-0110-02	FA-1000-02	FA-0100-02
		
FA-0010-02	FA-0000-02	

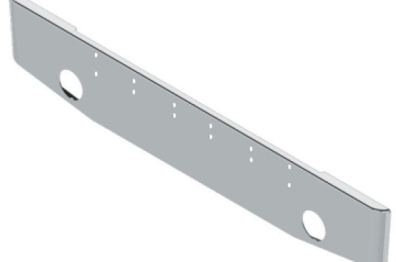

LOGGER YEARS 1967-1981

FF

		
FF-1090-02	FF-1000-02	
		
FF-0090-02	FF-0000-02	



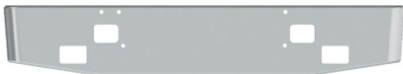
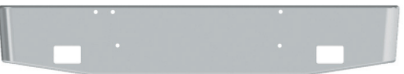
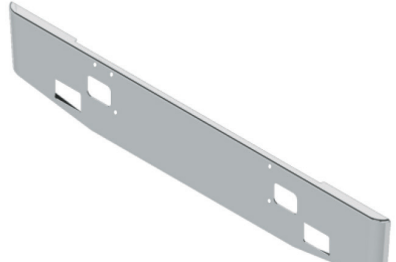

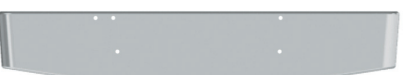
K100E YEARS 1984-1999

FB

		
FB-2010-02	FB-2000-02	
		
FB-0010-02	FB-0000-02	

KENWORTH BUMPERS

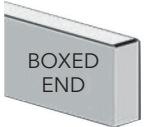
AVAILABLE STYLES FOR PRODUCTS ON THIS PAGE:

 <p>TAPER ROLLED END</p>	Width	End Style Code	 <p>GULLWING</p>	 <p>BOXED END</p>	Width	End Style Code	 <p>SQUARE ROLLED END</p>	Width	End Style Code
	12"	01			12"	09		12"	04
	16"	02			16"	10		16"	05
	18"	03			18"	11		18"	06
	20"	31			20"	51		20"	41
22"	32	22"	52	22"	42				

Width	End Style Code
16"	07

FD

W900A YEARS 1967-1981



FD-1210-07



FD-1200-07



FD-1010-07



FD-0210-07



FD-1000-07



FD-0200-07



FD-0010-07



VK120003
Tow Pin Covers (pair)
Fits FD,FE,FT & more



FD-0000-07

FE

W900B YEARS 1982-2010 • W900L YEARS 1982 & NEWER



FE-2210-02



FE-2200-02

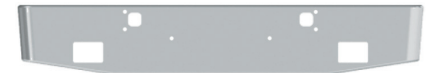

FE-2010-02



FE-0210-02

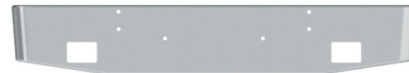

FE-2000-02



FE-0200-02

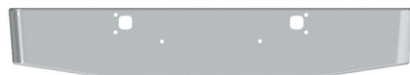

FE-0010-02



FE-0210-02

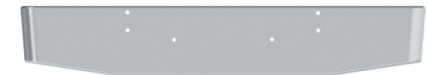

FE-0000-02

FT

W900B YEARS 2011 & NEWER, DOES NOT FIT W900L



FT-2210-06



FT-2200-06



FT-2010-06



FT-0210-06



FT-2000-06



FT-0200-06



FT-0010-06

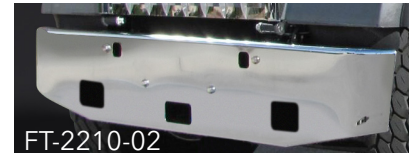

FT-2210-02



FT-0000-06

KENWORTH BUMPERS

EXAMPLE STYLES FOR PRODUCTS ON THIS PAGE:

Width	End Style Code
12"	01
16"	02
18"	03
20"	31
22"	32



TAPER ROLLED END

Width	End Style Code
16"	07

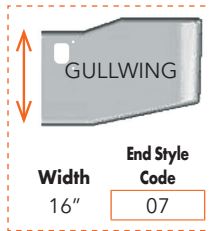

GULLWING

Width 16" End Style Code 07

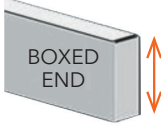

BOXED END

Width	End Style Code
12"	09
16"	10
18"	11
20"	51
22"	52

Width	End Style Code
12"	04
16"	05
18"	06
20"	41
22"	42

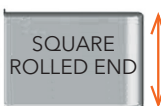

SQUARE ROLLED END

W900S YEARS 1989-2007

FJ



FJ-2010-01



FJ-2000-01

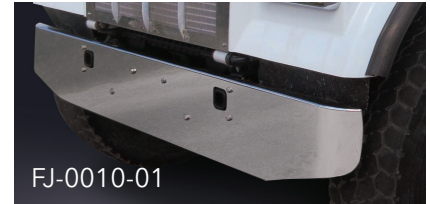

FJ-0010-01



FJ-0010-01



FJ-0000-01

W900S YEARS 2008 & NEWER

FQ



FQ-2210-02



FQ-2200-02



FQ-2010-02



FQ-0210-02



FQ-2000-02



FQ-0200-02

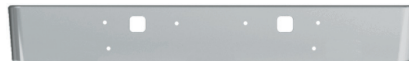

FQ-0010-02



FQ-0010-02

W990 YEARS 2018-2020

FW



FW-2210-06



FW-2000-06



FW-0210-06



FW-2010-06



FW-0010-06



FW-0210-06



FW-0000-06

KENWORTH BUMPERS

AVAILABLE STYLES FOR PRODUCTS ON THIS PAGE:



Width	End Style Code
14"	25
16"	13
18"	14

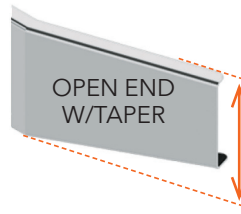

Width	End Style Code
14"	26
16"	132T
18"	142T

FG

T800 YEARS 1986-2003



FG-2191-25



FG-2190-25



FG-2101-25



FG-2091-25



FG-0191-25



FG-2100-25



FG-2090-25



FG-2001-25



FG-0190-25



FG-0101-25



FG-0091-25



FG-2000-25



FG-0100-25



FG-0090-25



FG-0001-25



FG-0101-25



FG-0000-25



FG-0101-26

FP

T800W WIDENOSE - YEARS 1988-2005

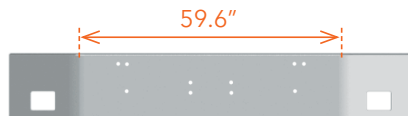
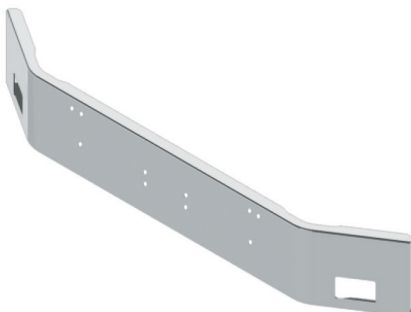

FP-2090-25



FP-2000-25

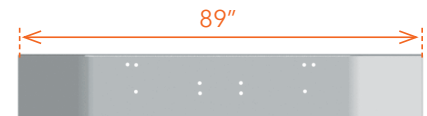

FP-0090-25



FP-0000-25

37.38"

KENWORTH BUMPERS

AVAILABLE STYLES FOR PRODUCTS ON THIS PAGE:



Width	End Style Code
14"	25
16"	13
18"	14

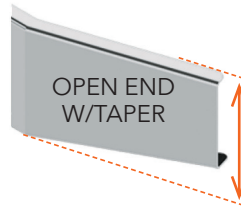

Width	End Style Code
14"	26
16"	132T
18"	142T

T800, T880 YEARS 2004 & NEWER

FN



FN-2111-25



FN-2110-25



FN-2100-25



FN-2010-25

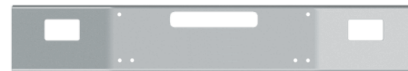

FN-2001-25



FN-2011-25

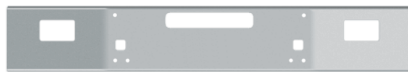

FN-2101-25



FN-2000-25



FN-0111-25



FN-0110-25



FN-0101-25



FN-0011-25



FN-0010-25



FN-0001-25

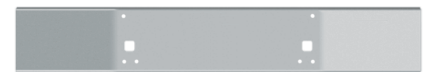

FN-0100-25



FN-2191-25

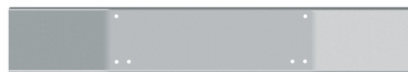

FN-0000-25



FN-0090-25



FN-0101-25

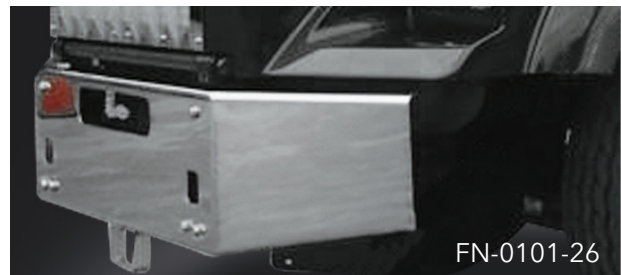

FN-0101-26

KENWORTH BUMPERS

AVAILABLE STYLES FOR PRODUCTS ON THIS PAGE:



Width	End Style Code
14"	25
16"	13
18"	14

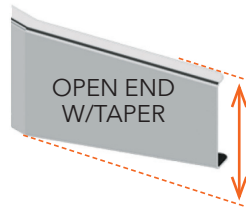

Width	End Style Code
14"	26
16"	132T
18"	142T

FK

T450B YEARS 1994-1997

SIMILAR BOLT PATTERN AS 'FG' SERIES BUT SHORTER BUMPER LENGTH

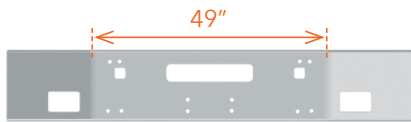

FK-2191-25

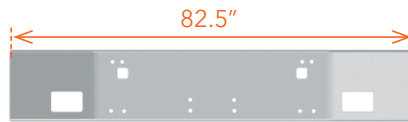

FK-2190-25



FK-2101-25



FK-2091-25



FK-0191-25

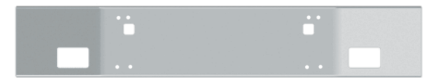

FK-2100-25



FK-2090-25



FK-2001-25



FK-0190-25



FK-0101-25



FK-0091-25

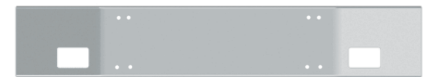

FK-2000-25

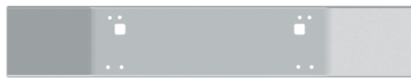

FK-0100-25



FK-0090-25



FK-0001-25

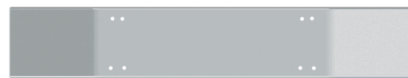

FK-0000-25



KENWORTH BUMPERS

AVAILABLE STYLES FOR PRODUCTS ON THIS PAGE:

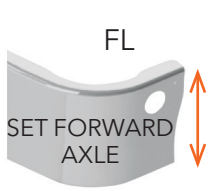

Width	End Style Code
13"	18
16"	19
18"	20
*20"	35

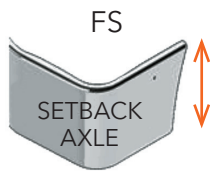

Width	End Style Code
16"	16

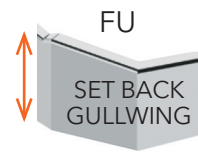

Width	End Style Code
15"	708
18"	709
*20"	711

* No warranty for 20" wide bumpers

T300 SET FORWARD AXLE YEARS 1997-2008

MOUNTS TO FACTORY BRACKETS

FL

LICENSE PLATE HOLES STANDARD



FL-0010-18

EXTERNAL STEP HOLES (STEP NOT INCLUDED)



FL-0000-18

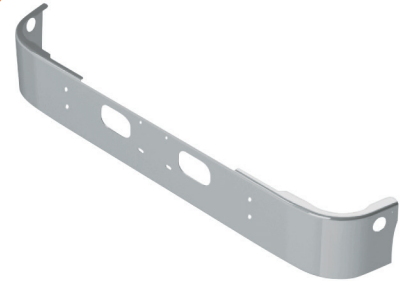

T270, T370 SET BACK AXLE YEARS 2008 & NEWER

ADAPTER BRACKETS INCLUDED. 16" WIDTH ONLY.

NOW BOLTLESS

FS



FS-2010-16



FS-2000-16



FS-0010-16

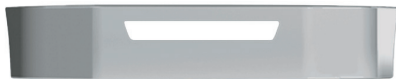

FS-0010-16

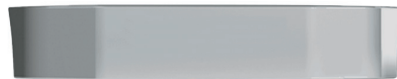

FS-0000-16

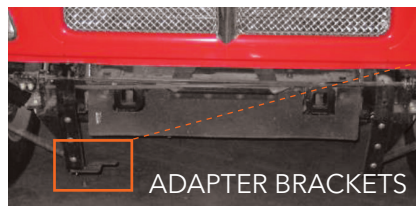

ADAPTER BRACKETS



NEW BOLTLESS MOUNTING BRACKETS

T440 SET BACK AXLE YEARS 2011 & NEWER

NOT AVAILABLE IN STAINLESS STEEL

FU



FU-0011-708



FU-0010-708



FU-0001-708



FU-0000-708

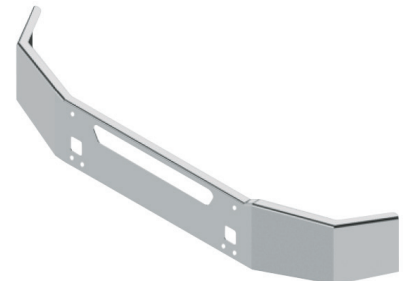

KENWORTH BUMPERS

AVAILABLE STYLES FOR PRODUCTS ON THIS PAGE:



Width	End Style Code
13"	15
16"	16
18"	17
*20"	34

* No warranty for 20" wide bumpers

FH

T600 YEARS 1987-2007

SPACERS INCLUDED. MUST INCLUDE VENT HOLES FOR WARRANTY.



FH-2011-15



FH-2001-15



FH-0011-15



FH-0001-15

FR

T660 YEARS 2008-2017
MOUNTING BRACKETS INCLUDED



FR-5011-15



FR-2011-15



FR-2001-15



FR-5001-15



FR-2000-15



FR-2010-15



FR-5010-15



FR-0010-15



FR-0011-15



FR-0001-15

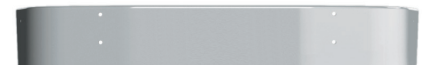

FR-0000-15

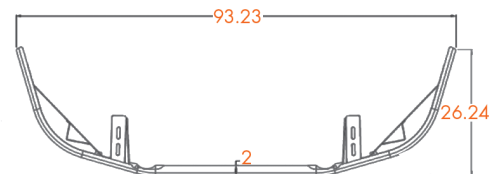

FM

T400 SET BACK AXLE YEARS 1989-2000



FM-2001-15



FM-0001-15

KENWORTH BUMPERS

AVAILABLE STYLES FOR PRODUCTS ON THIS PAGE:

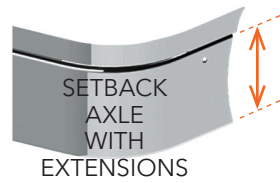

Width	End Style Code
14"	708
16"	709
18"	711
*20"	712

* No warranty for 20" wide bumpers

T680 SET BACK AXLE YEARS 2013 & NEWER

MOUNTING BRACKETS INCLUDED
(NOW IN -708 END STYLE (ONE-PIECE))

FV



FV-5210-708
2 OEM fogs, step, tow pins



FV-0010-708-V4
Tow pins, radar accommodation



FV-0210-708
Step, tow pins



FV-5010-708
2 OEM fogs, tow pins



FV-0010-708
Tow pins



FV-0000-708
Mounting only



FV-0010-708



FV-0010-708-V4
Tow pins, radar accommodation

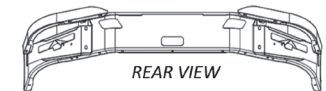
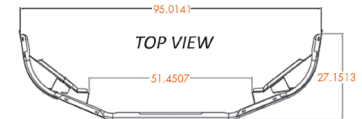

T680 GEN II SET BACK AXLE YEARS 2021 & NEWER

MOUNTING BRACKETS INCLUDED
(NOW IN -708 END STYLE (ONE-PIECE))

FX



FX-0000-708
Mounting only



FX-0010-708
Tow pins



FX-0010-708-V4
Tow pins, radar accommodation



FX-5210-708
2 OEM fogs, step, tow pins



FX-5010-708
2 OEM fogs, tow pins



FX-5011-708
Vent, 2 OEM fogs, tow pins

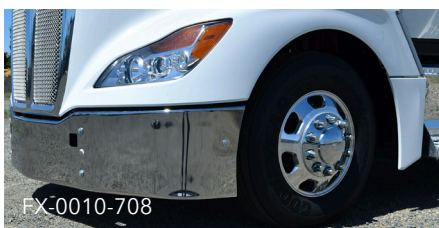

FX-0010-708



FX-0011-708
Vent, tow pins



FX-0210-708
Step, tow pins

KENWORTH BUMPERS

AVAILABLE STYLES FOR PRODUCTS ON THIS PAGE:



12"	18
16"	19
18"	20
20"	35

* No warranty for 20" wide bumpers

T280, T380 & T480 SET FORWARD AXLE YEARS 2021 & NEWER **FY**

MOUNTS TO FACTORY BRACKETS FOR STEEL REPLACEMENT
(SEPARATE BRACKETS REQUIRED TO REPLACE FACTORY URETHANE)



FY-5000-18
Fog



FY-5001-18



FY-5001-18
Fog, Vent



FY-0000-18
Mount Only



FY-0001-18
Vent

W990 YEARS 2021 & NEWER

FZ



FZ-0000-117
Mount Only



FZ-0000-118
Mount Only



FZ-0010-117
Center Tow



FZ-0010-118
Center Tow



FZ-2010-117
Square Fog, Center Tow



FZ-2010-118
Square Fog, Center Tow



FZ-6010-117
OE Fog, Steps, Center Tow



FZ-6010-118
OE Fog, Steps, Center Tow

KENWORTH BUMPERS

AVAILABLE STYLES FOR PRODUCTS ON THIS PAGE:

T880S SET FORWARD AXLE YEARS 2017-2023

FOA



FOA-0000-02
Mount Only



FOA-0000-06
Mount Only



FOA-0010-02
Tow Pins



FOA-0010-06
Tow Pins

T880 SETBACK AXLE YEARS 2014 & NEWER

FOB



FOB-0101-15
Tow Pins, Vent



FOB-0101-26
Tow Pins, Vent

MACK BUMPERS

EXAMPLE STYLES FOR PRODUCTS ON THIS PAGE:

Width	End Style Code	Width	End Style Code	Width	End Style Code
12"	01	12"	09	12"	04
16"	02	16"	10	16"	05
18"	03	18"	11	18"	06
20"	31	20"	51	20"	41
22"	32	22"	52	22"	42

GA

R, RL, F, FL, FS

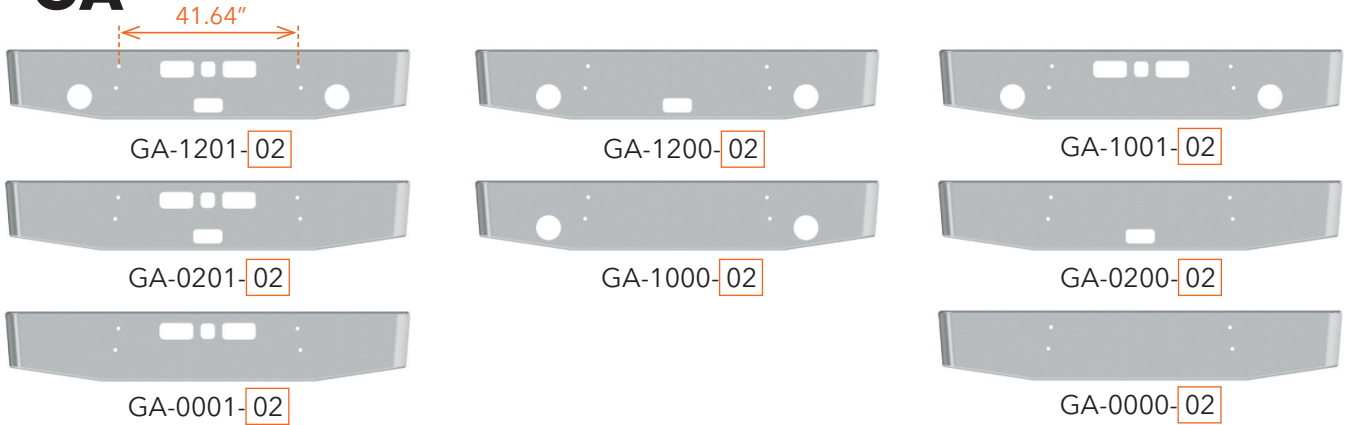

GB

SUPERLINER, CRUISELINER

NOT AVAILABLE IN 12" WIDTH
SUPERLINER NOT AVAILABLE IN GULLWING STYLE-07

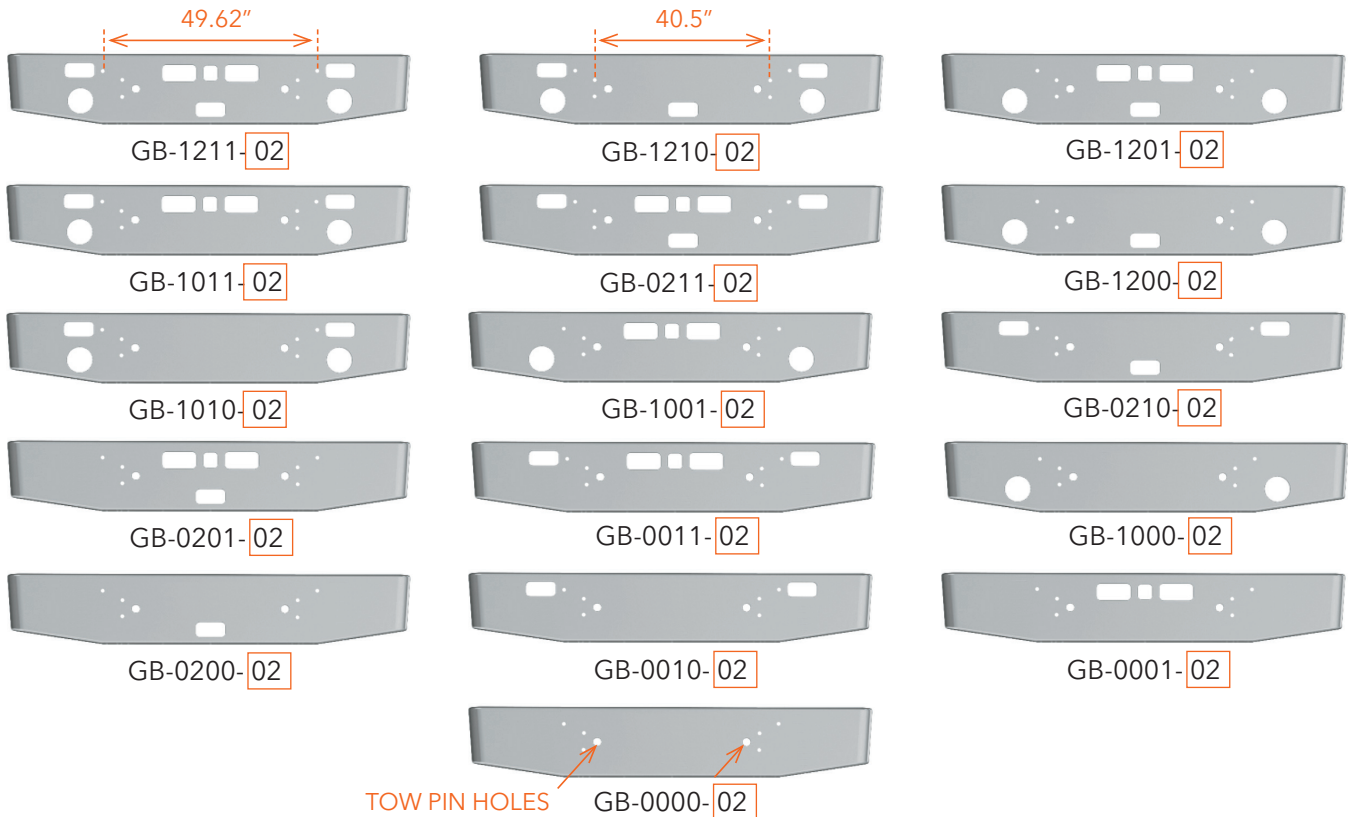

MACK BUMPERS

EXAMPLE STYLES FOR PRODUCTS ON THIS PAGE:

Width	End Style Code	Width	End Style Code	Width	End Style Code
12"	01	12"	09	12"	04
16"	02	16"	10	16"	05
18"	03	18"	11	18"	06
20"	31	20"	51	20"	41
22"	32	22"	52	22"	42

R-600, R-700

ADD- GG TO END OF ANY 'GC' PART NUMBER FOR GRILLE GUARD HOLES

GC

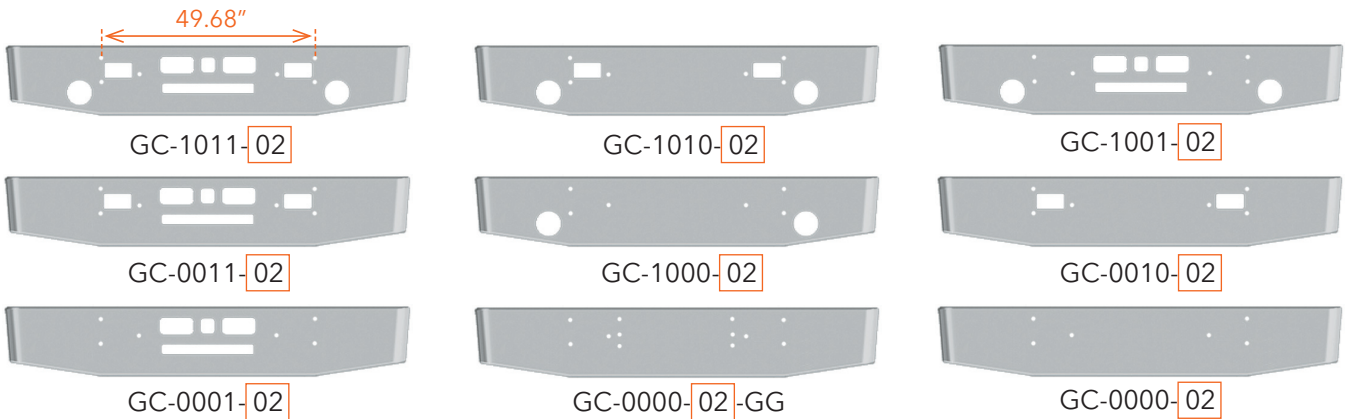

GRILLE GUARDS

FIT OEM BUMPERS AND OUR BUMPERS GC, GH, GS, GV
DOES NOT FIT OUR 'GZ' BUMPERS (SEE PAGE 54)
STAINLESS STEEL ONLY



F-600

GD

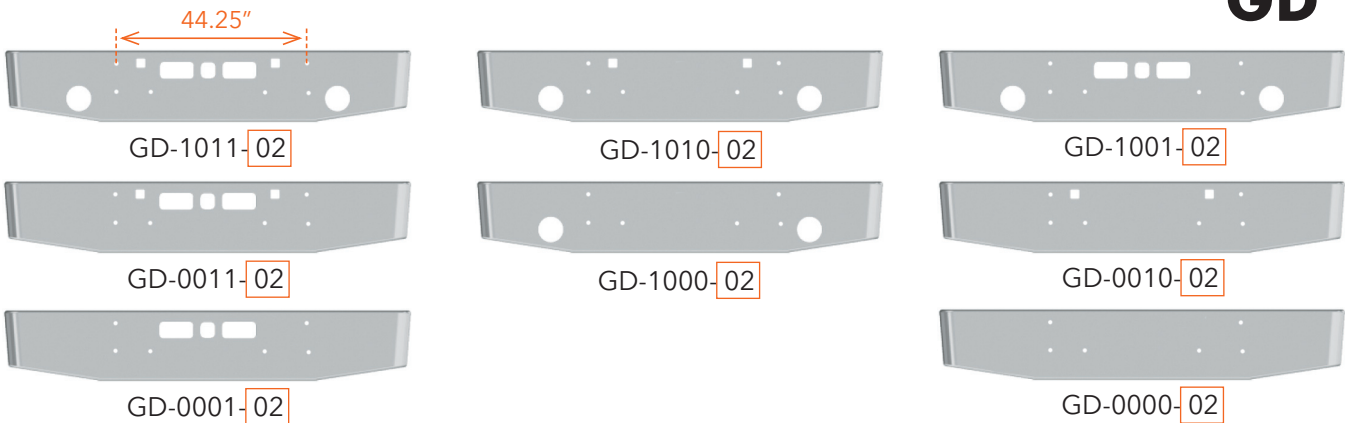

MACK BUMPERS

EXAMPLE STYLES FOR PRODUCTS ON THIS PAGE:

Width	End Style Code	Width	End Style Code	Width	End Style Code
12"	01	12"	09	12"	04
16"	02	16"	10	16"	05
18"	03	18"	11	18"	06
20"	31	20"	51	20"	41
22"	32	22"	52	22"	42

GE

VALUELINER, WESTCOAST

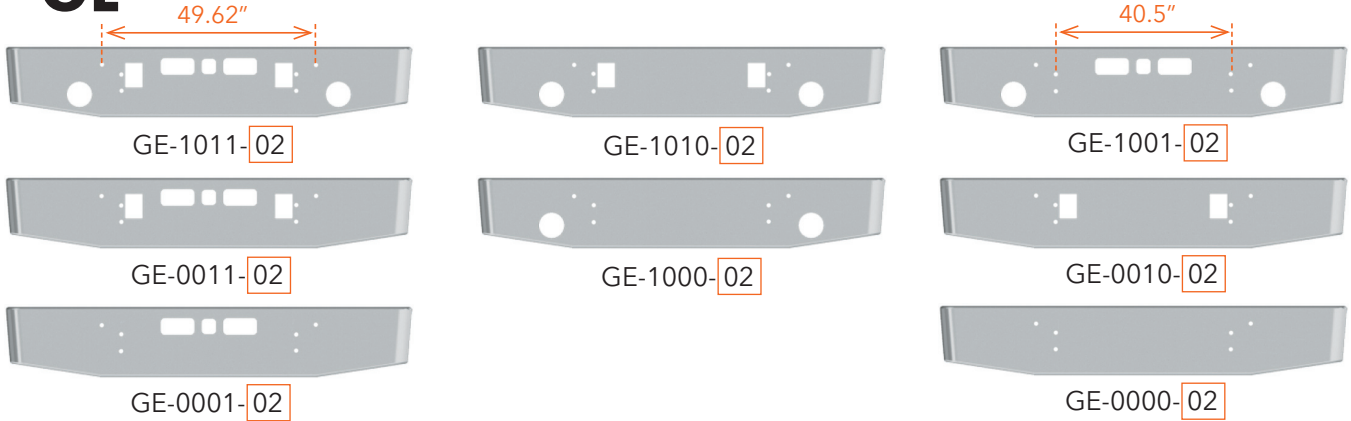

GF

F-700, INTERSTATE

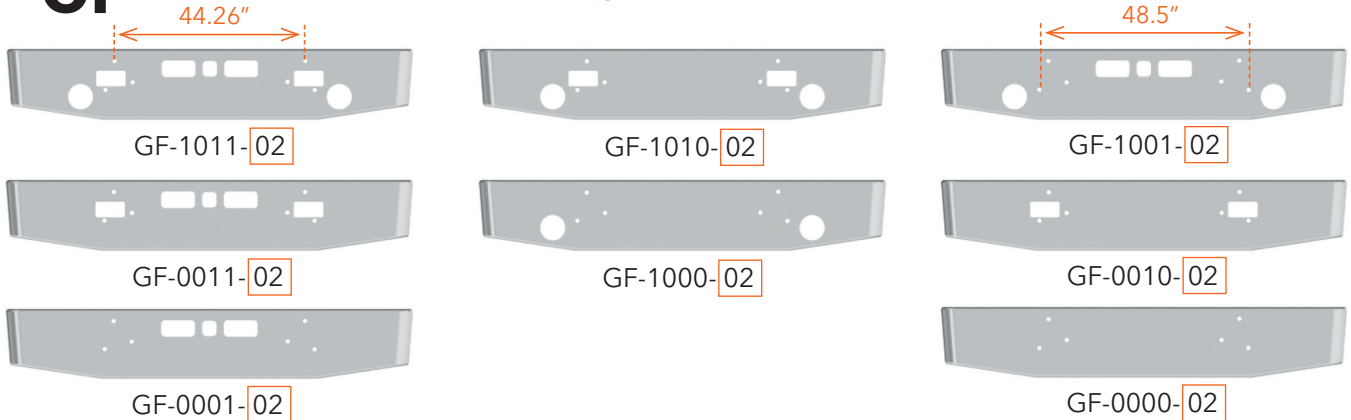

GR

R600 YEARS 1965 TO 1976

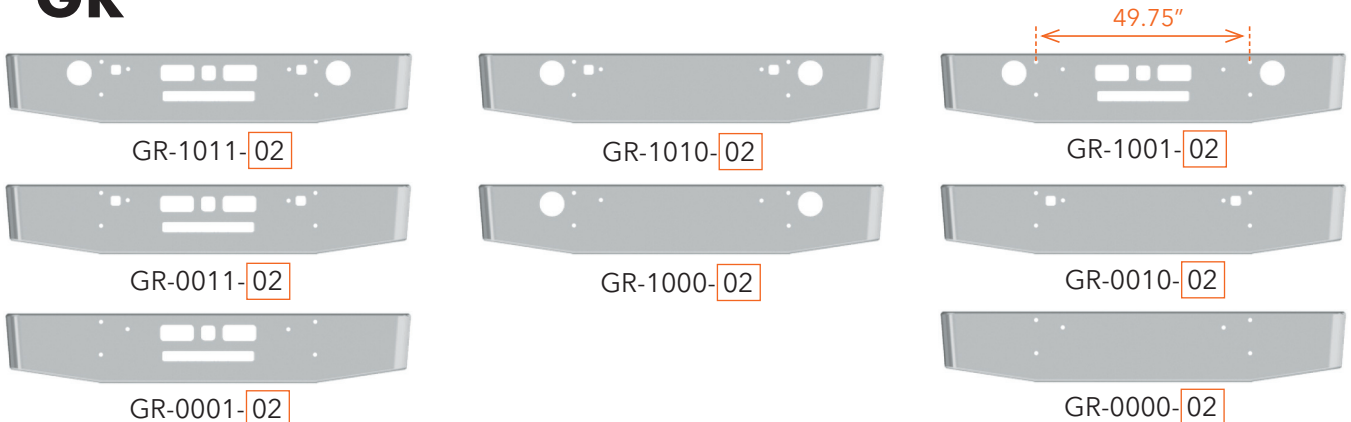

MACK BUMPERS

EXAMPLE STYLES FOR PRODUCTS ON THIS PAGE:

Width	End Style Code	Width	End Style Code	Width	End Style Code
12"	01	12"	09	12"	04
16"	02	16"	10	16"	05
18"	03	18"	11	18"	06
20"	31	20"	51	20"	41
22"	32	22"	52	22"	42

MH COE, SUPERLINER II, RW613

NOT AVAILABLE IN 12" WIDTH

GG

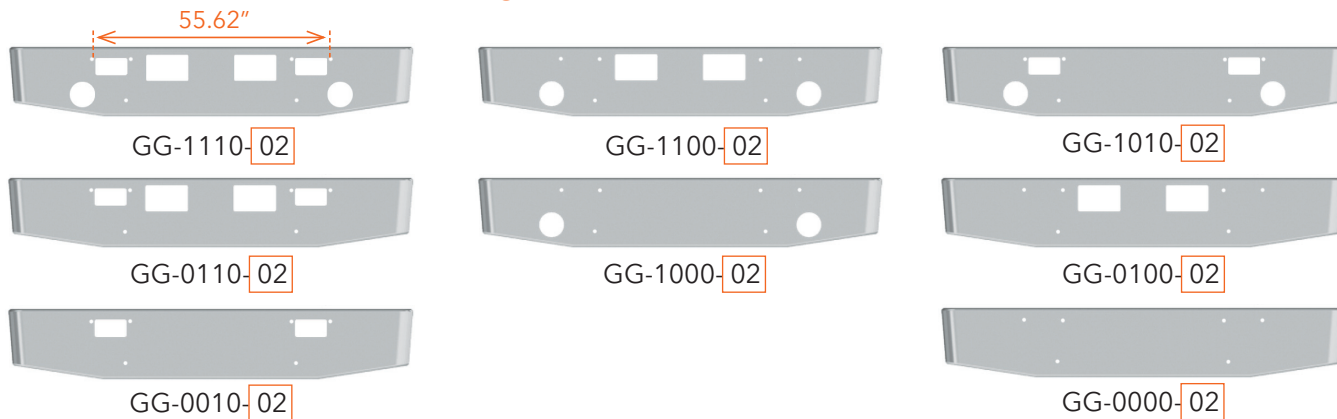

WESTERN CONTRACTOR, RD688, RD690 YEARS 1989-2001

ADD-GG TO END OF ANY 'GH' PART NUMBER FOR GRILLE GUARD HOLES

GH

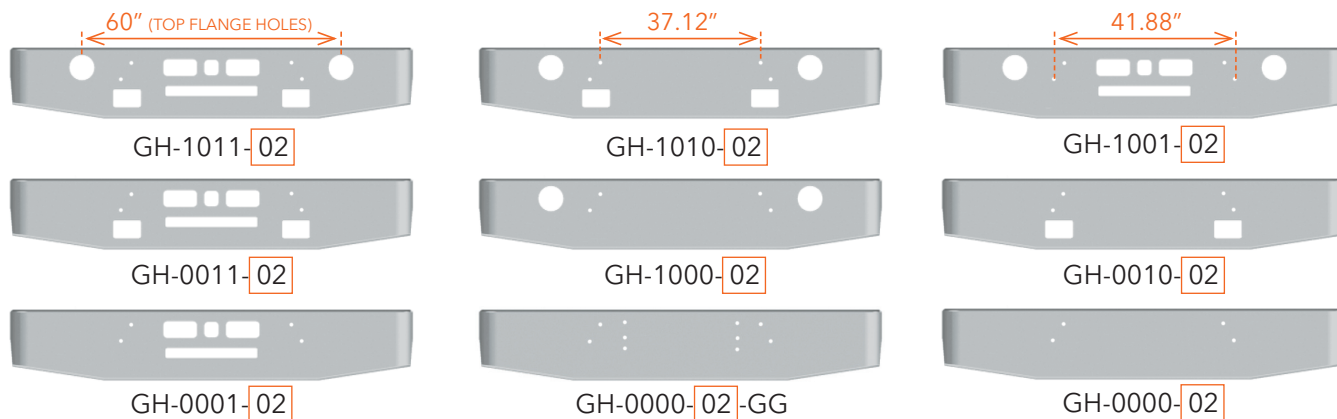

GRILLE GUARDS

FIT OEM BUMPERS AND OUR BUMPERS GC, GH, GS, GQ, GV

DOES NOT FIT OUR 'GZ' BUMPERS (SEE PAGE 54)

STAINLESS STEEL ONLY



AC-GCGGS-FLAMES



AC-GCGGS

MACK BUMPERS

AVAILABLE STYLES FOR PRODUCTS ON THIS PAGE:

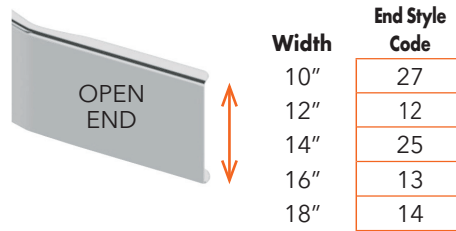

GI

LOGGER

NOT AVAILABLE IN 10" WIDTH (-27). NOTE LETTERS 'GI' IN PART NUMBER

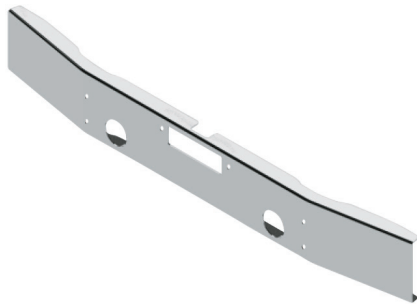

GI-1010-12



GI-0010-12

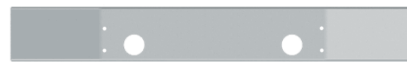

GI-1000-12

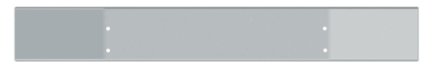

GI-0000-12

GS

RD SET BACK AXLE YEARS 1979-1988

GRILLE GUARD HOLES ARE STANDARD

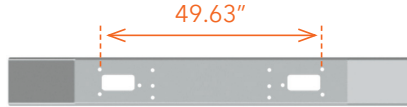
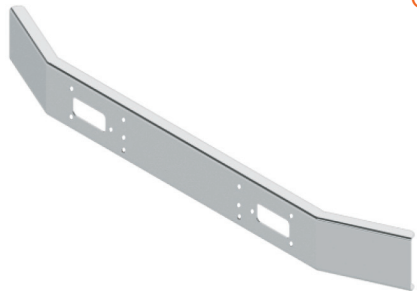

GS-0010-12



GS-0000-12

SEE PAGE 53 FOR GRILLE GUARDS

GP

MR, MRU, MD SERIES YEARS 2018 & OLDER

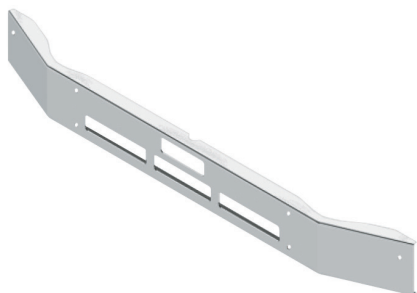

GP-0011-27



GP-0010-27

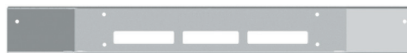

GP-0001-27

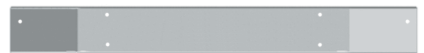

GP-0000-27

MACK BUMPERS

AVAILABLE STYLES FOR PRODUCTS ON THIS PAGE:

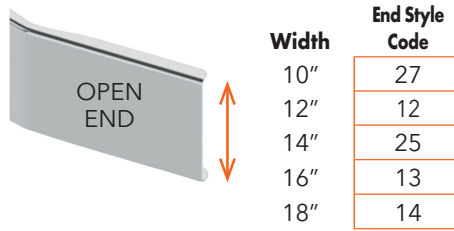

CL SERIES YEARS 1994-2003

GN

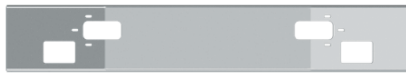

GN-2010-25



GN-2020-25



OUTBOARD
TOW PIN HOLES

GN-0010-25



CENTER
TOW PIN HOLE

GN-0020-25

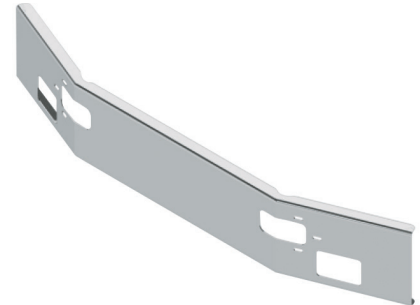

RD688, RD690 YEARS 1993-2003

GRILLE GUARD HOLES ARE STANDARD

GQ

SEE BELOW
FOR GRILLE GUARDS



GQ-0000-27

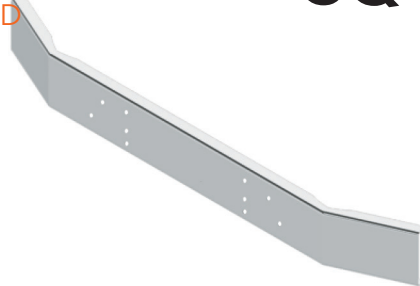

CV SERIES, RD688DM YEARS 2003-2007

GRILLE GUARD HOLES ARE STANDARD

SEE BELOW FOR GRILLE GUARDS

GV

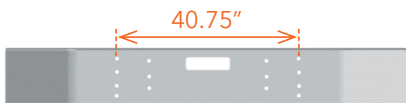

GV-0010-12



GV-0000-12

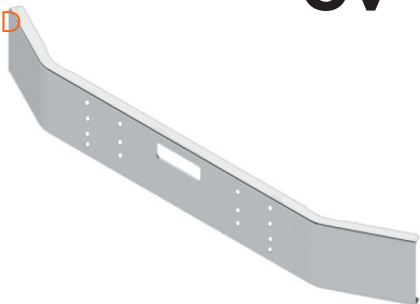

GRILLE GUARDS

FIT OEM BUMPERS AND OUR BUMPERS GC, GH, GS, GQ, GV

DOES NOT FIT OUR 'GZ' BUMPERS (SEE PAGE 54)

STAINLESS STEEL ONLY



AC-GCGGS-FLAMES

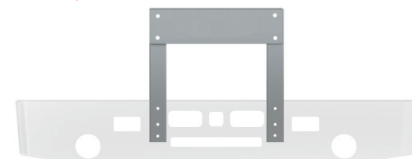

AC-GCGGS

MACK BUMPERS

AVAILABLE STYLES FOR PRODUCTS ON THIS PAGE:

GZ			GT			GT		
	Width	End Style Code		Width	End Style Code		Width	End Style Code
	10"	27		12"	01		12"	04
	12"	12		16"	02		16"	05
	14"	25		18"	03		18"	06
	16"	13		20"	31		20"	41
	18"	14		22"	32		22"	42

GZ

GRANITE, CTP713, GU713

YEARS 2007 & NEWER

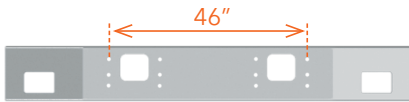

GZ-2010-12



GZ-2020-12



GZ-0011-12

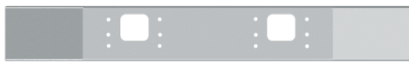

GZ-0010-12



GZ-0020-12

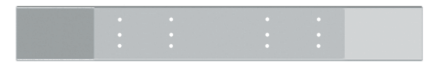

GZ-0000-12



GZ-0010-12

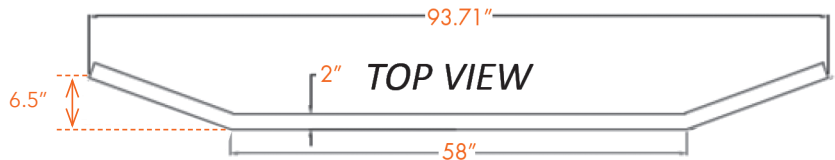

GRILLE GUARDS

FITS GZ BUMPERS AND
OEM EQUIVALENTS ONLY
STAINLESS STEEL ONLY
FOR OTHER MACK GRILLE
GUARDS SEE PAGE 53

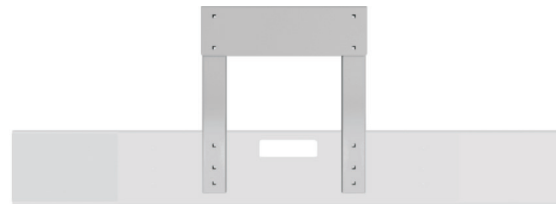

AC-GZGGS

GT

GRANITE, BRIDGE FORMULA

YEARS 2003-2007

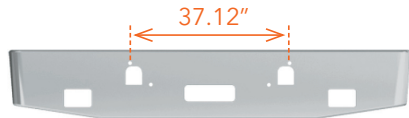

GT-2210-02



GT-2200-02



GT-2010-02



GT-0210-02



GT-2000-02



GT-0200-02

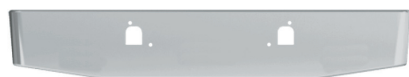

GT-0010-02

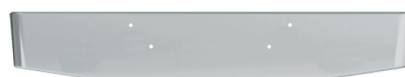

GT-0000-02

MACK BUMPERS

AVAILABLE STYLES FOR PRODUCTS ON THIS PAGE:

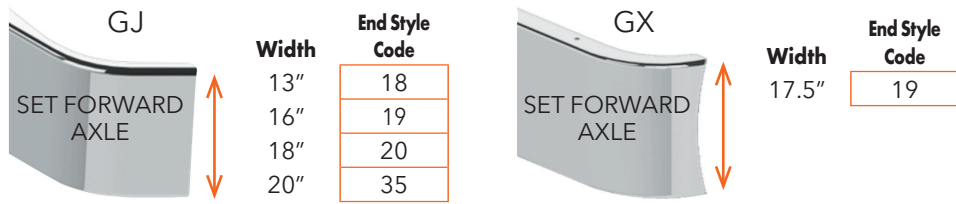

CH SERIES SET FORWARD AXLE YEARS 1994-2004 BRACKETS INCLUDED & BOLTED IN

GJ

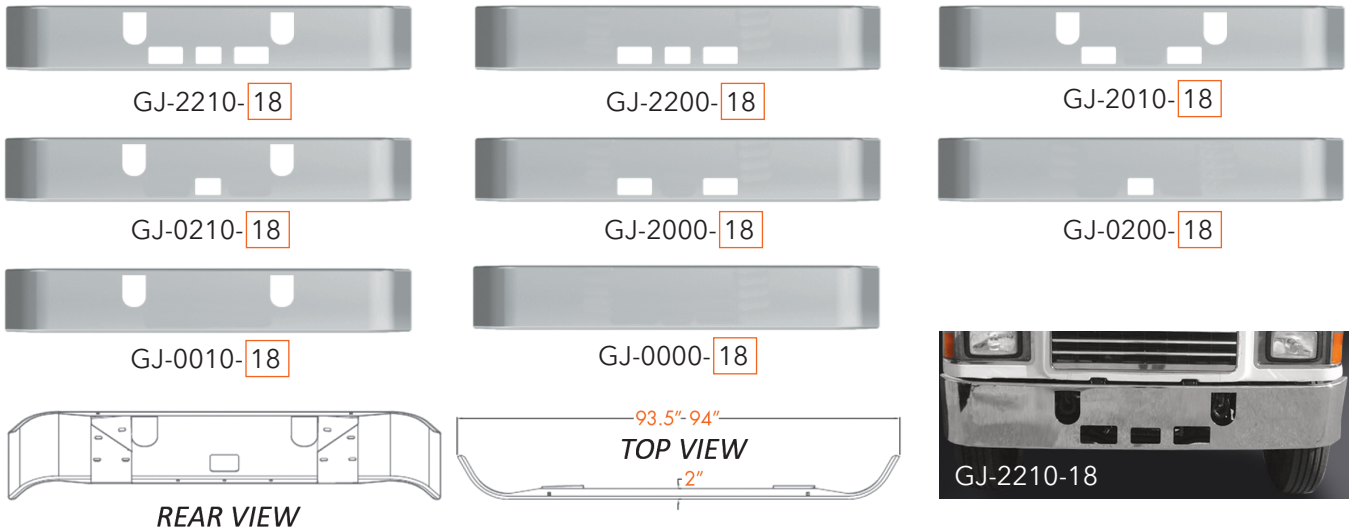

CH SERIES SET FORWARD AXLE YEARS 2005 & NEWER ALSO FITS RAWHIDE

GX

MOUNTS TO FACTORY BRACKETS, BRACKETS NOT INCLUDED. LICENSE PLATE HOLES INCLUDED.

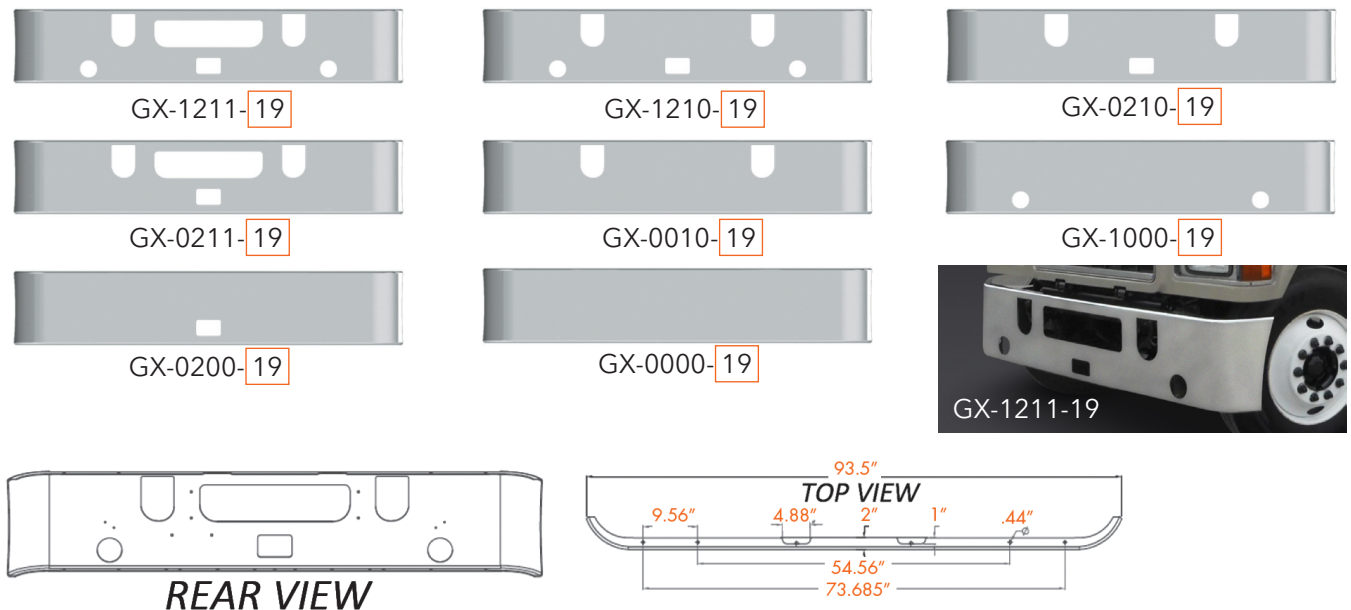

MACK BUMPERS

AVAILABLE STYLES FOR PRODUCTS ON THIS PAGE:



Width	End Style Code
14"	15
16"	16
18"	17
*20"	34

* No warranty for 20" wide bumpers

GM

CH SERIES SET BACK AXLE YEARS 1988-1993 BRACKETS INCLUDED & BOLTED IN



GM-2210-15



GM-2200-15



GM-2100-15



GM-0210-15



GM-2000-15



GM-0200-15

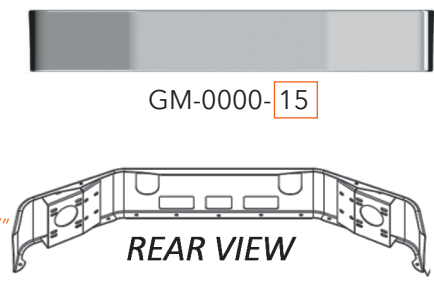
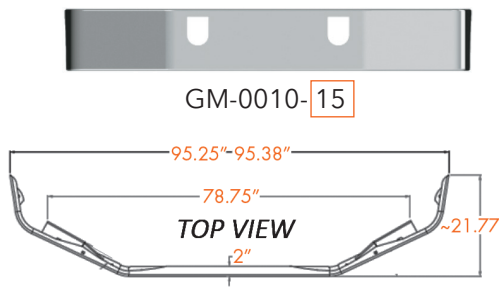
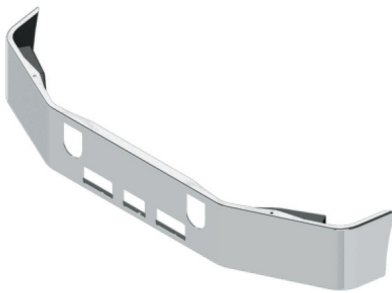

GL

CH SERIES SET BACK AXLE YEARS 1994-2004 BRACKETS INCLUDED & BOLTED IN



GL-2210-15



GL-2200-15



GL-2100-15



GL-0210-15



GL-2000-15



GL-0200-15

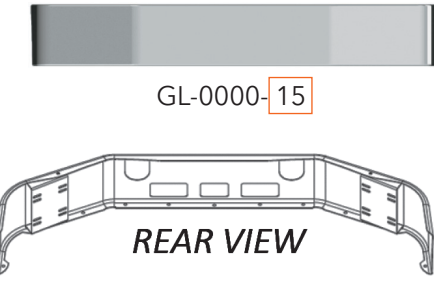
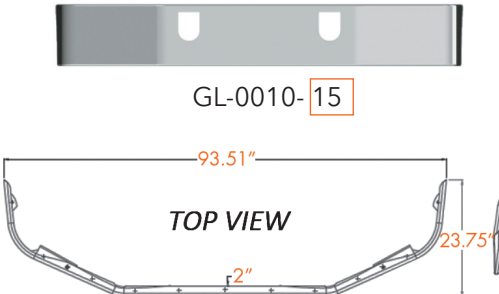
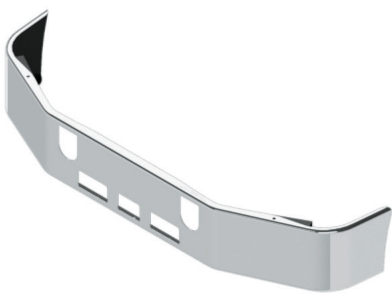

MACK BUMPERS

AVAILABLE STYLES FOR PRODUCTS ON THIS PAGE:



SETBACK AXLE

Width	End Style Code
16"	16
18"	17
*20"	34

* No warranty for 20" wide bumpers

CX SERIES, VISION SET BACK AXLE YEARS 2001-2004 MOUNTING BRACKETS INCLUDED

GU



GU-2210-16



GU-2200-16



GU-2010-16



GU-0210-16



GU-2000-16



GU-0200-16



GU-0010-16

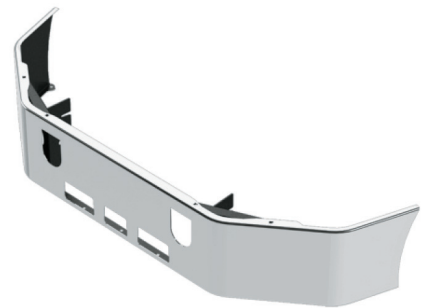
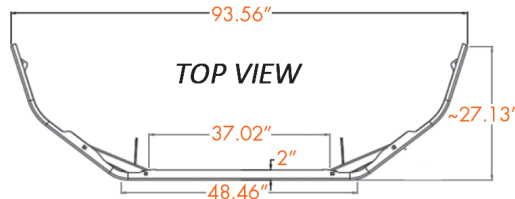
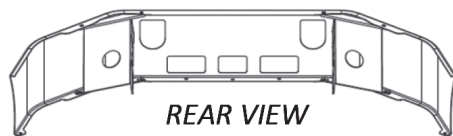

CXP, CXN SERIES SET BACK AXLE YEARS 2005 & NEWER MOUNTING BRACKETS INCLUDED ONE SET UPPER LICENSE PLATE HOLES INCLUDED

GW



GW-1210-16



GW-1200-16



GW-1010-16



GW-0210-16



GW-1000-16

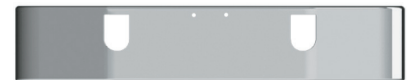

GW-0010-16

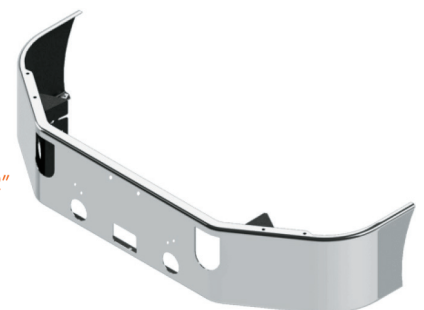
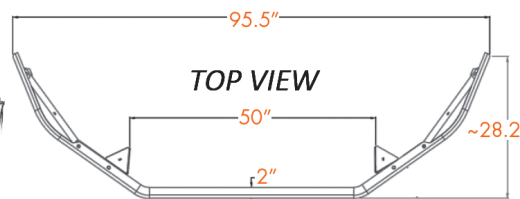
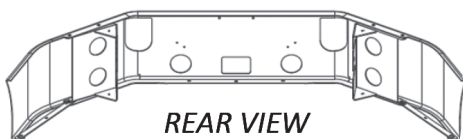

MACK BUMPERS

AVAILABLE STYLES FOR PRODUCTS ON THIS PAGE:



Width	End Style Code
16"	16
18"	17
*20"	34

* No warranty for 20" wide bumpers

GY

CXU SERIES SET BACK AXLE YEARS 2008 & NEWER
 BRACKETS NOT INCLUDED. REPLACES STAINLESS CLAD BUMPERS.
 BRACKETS REQUIRED FOR URETHANE REPLACEMENT - SEE BELOW

ANTHEM SET BACK AXLE YEARS 2017 & NEWER
 BRACKETS NOT INCLUDED - REPLACES STAINLESS CLAD BUMPERS ONLY



GY-1211-16
 Round fogs, step, tow, vent holes



GY-1200-16
 Round fogs, step holes



GY-0211-16
 Step, tow, vent holes



GY-0210-16
 Step, tow holes



GY-0010-16
 Tow holes



GY-0200-16
 Step hole

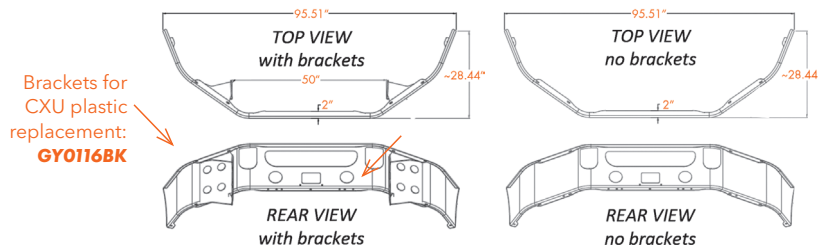

MACK BUMPERS

EXAMPLE STYLES FOR PRODUCTS ON THIS PAGE:

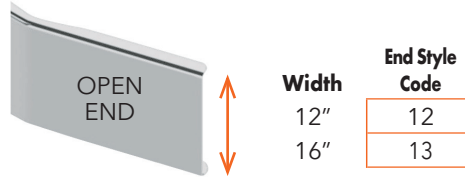

MD6 & MD7 YEARS 2021 & NEWER
MOUNTS TO FACTORY BRACKETS

GOA



GOA-0000-12
No Cutouts

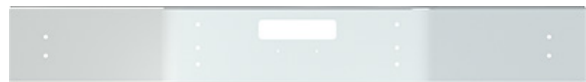

GOA-0010-12
Center Tow

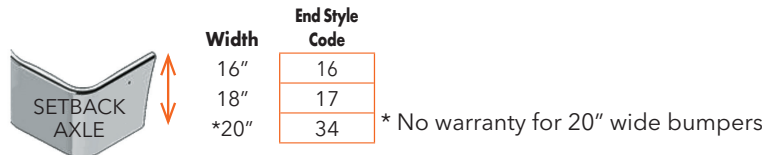

ANTHEM SET BACK AXLE YEARS 2018 & NEWER
BRACKETS INCLUDED - REPLACES URETHANE BUMPERS ONLY

GOB



GOB-0000-16
Mount Only



GOB-0001-16
Vent Hole



GOB-0010-16
Tow Holes



GOB-0011-16
Tow Holes, Vent Hole



GOB-0211-16
Center Step, Tow Holes, Vent Hole



GOB-2001-16
2 Square Fogs, Vent Hole



PETERBILT BUMPERS

EXAMPLE STYLES FOR PRODUCTS ON THIS PAGE:

Width	End Style Code	Width	End Style Code	Width	End Style Code
12"	01	12"	09	12"	04
16"	02	16"	10	16"	05
18"	03	18"	11	18"	06
20"	31	20"	51	20"	41
22"	32	22"	52	22"	42

352 CABOVER YEARS 1967-1980

HA

359 CONVENTIONAL YEARS 1967-1986



HA-1010-02



HA-1000-02



HA-0010-02



HA-2010-02



HA-2000-02



HA-0000-02

LOGGER YEARS 1973-1986

HE



HE-1090-02



HE-1000-02



HE-0090-02



HE-0000-02

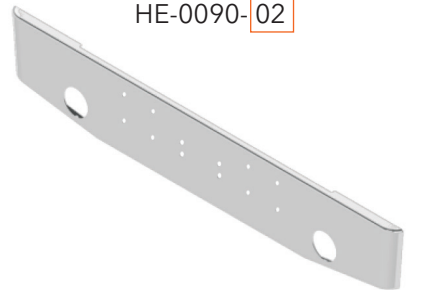

362 CABOVER YEARS 1981 & NEWER

NOT AVAILABLE IN 12" WIDTH (-01,-04,-09,-91)

HK



HK-1110-02



HK-1100-02



HK-1010-02



HK-0110-02



HK-1000-02



HK-0100-02



HK-0010-02



HK-0000-02

PETERBILT BUMPERS

EXAMPLE STYLES FOR PRODUCTS ON THIS PAGE:

Width	End Style Code	Width	End Style Code	Width	End Style Code
12"	01	12"	09	12"	04
16"	02	16"	10	16"	05
18"	03	18"	11	18"	06
20"	31	20"	51	20"	41
22"	32	22"	52	22"	42

HD

375 CONVENTIONAL YEARS 1987-1994



HD-2011-02



HD-2010-02



HD-2001-02

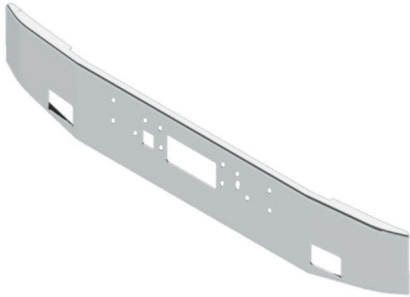

HD-0011-02



HD-0010-02



HD-0001-02



HD-0000-02

HC

379, 378, 357 YEARS 1987-2007



HC-2010-02



HC-2000-02



HC-0010-02



HC-0020-02



HC-0000-02



HC-0010-06

SEE PAGE 61 FOR SUPPORT BRACKETS

HF

LOGGER YEARS 1987-2007



HF-2090-02



HF-0090-02



HF-3090-01



HF-0090-01

PETERBILT BUMPERS

BUMPER SUPPORT BRACKETS – MODEL 379

VP15-06333L-22

for 20" to 22" bumpers



VP15-06333L-20

for 16" to 20" bumpers

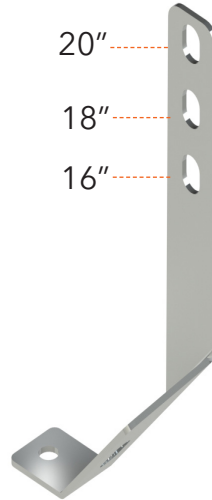

MARKED FOR DRIVER & PASSENGER SIDES



ADD THESE BRACKETS FOR A MORE RIGID INSTALLATION.
POWDER-COATED STEEL.
FASTENERS NOT INCLUDED.
SOLD AS A PAIR.

BUMPER SUPPORT BRACKETS – MODEL 389 & 589

VCN11-6061-22

for 20" to 22" bumpers



VCN11-6061-20

for 16" to 20" bumpers



OEM bracket N11-6061

For 16" bumpers
(shown for comparison)



SAME BRACKET USED FOR DRIVER & PASSENGER SIDES

PETERBILT BUMPERS

EXAMPLE STYLES FOR PRODUCTS ON THIS PAGE:

Width	End Style Code	Width	End Style Code	Width	End Style Code
12"	01	12"	09	12"	04
16"	02	16"	10	16"	05
18"	03	18"	11	18"	06
20"	31	20"	51	20"	41
22"	32	22"	52	22"	42

HV

365, 367, 388, 389, 567, YEARS 2007 & NEWER
589, YEARS 2024 & NEWER



HV-2210-02



HV-2200-02

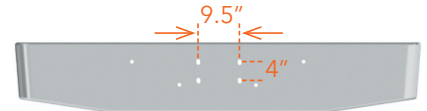

HV-0090-02



HV-0010-06

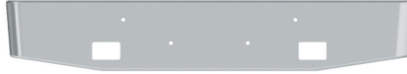

HV-2000-02



HV-0210-02

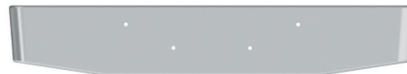

HV-0000-02



HV-0010-02

SEE PAGE 61 FOR SUPPORT BRACKETS

HOB

388 HIGH CLEARANCE YEARS 2007 & NEWER
 NOTE LETTERS 'HOB' IN PART NUMBER



HOB-2090-01



HOB-2000-01



HOB-0090-01

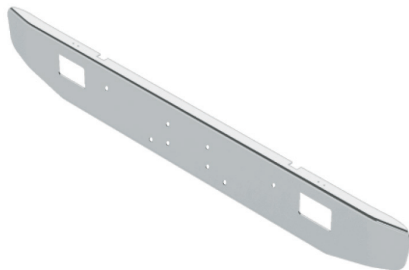

HOB-0010-01



HOB-0000-01



PETERBILT BUMPERS

AVAILABLE STYLES FOR PRODUCTS ON THIS PAGE:



SET FORWARD AXLE

Width	End Style Code
13"	18
16"	19
18"	20
20"	35

362E SET FORWARD AXLE

HQ



HQ-2210-18



HQ-2200-18



HQ-2010-18



HQ-0210-18



HQ-0010-18



HQ-0200-18

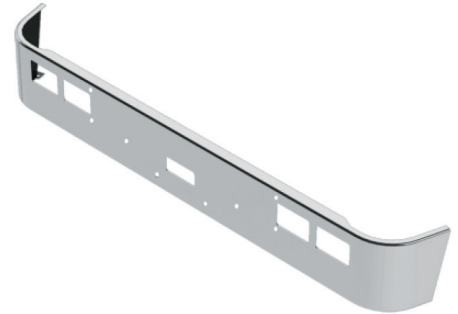

377 SET FORWARD AXLE YEARS 1987-1991

NOTE LETTERS 'HI' IN PART NUMBER

HI



HI-2010-18



HI-2000-18



HI-0010-18



HI-0000-18

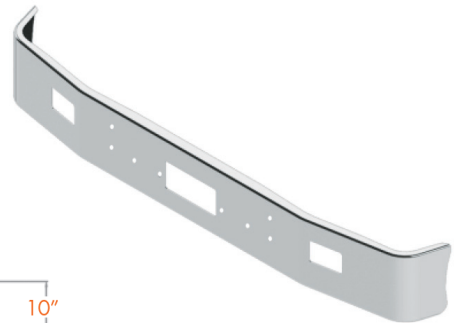
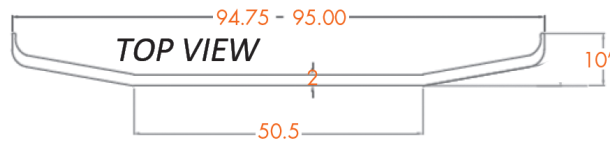

377AE, 375 SET FORWARD AXLE YEARS 1987 & NEWER

HJ



HJ-2010-18

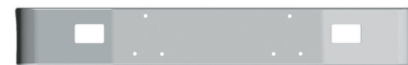

HJ-2000-18



HJ-0010-18

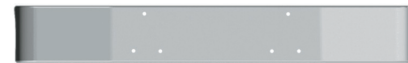

HJ-0000-18

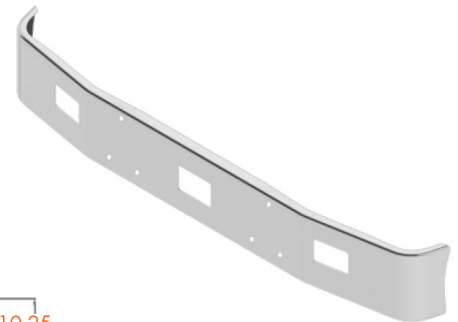
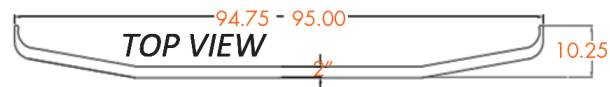

PETERBILT BUMPERS

AVAILABLE STYLES FOR PRODUCTS ON THIS PAGE:



Width	End Style Code
10"	27
12"	12
14"	25
16"	13
18"	14

HG

357, 378 SETBACK AXLE YEARS 1987-2004

SEE BELOW FOR TOP FLANGE STEP PLATES
CHECK 'HOD' SERIES PRIOR TO ORDERING

TOP PLATES:

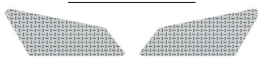





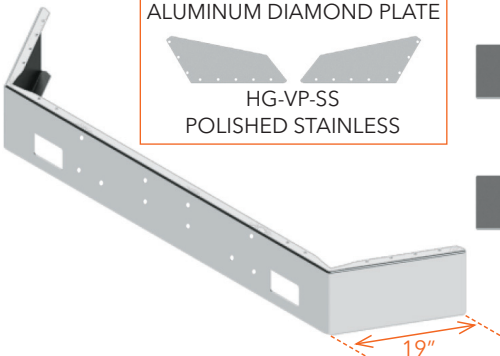

HG-VP-AD
ALUMINUM DIAMOND PLATE



HG-VP-SS
POLISHED STAINLESS











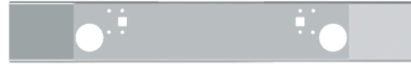
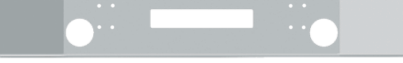
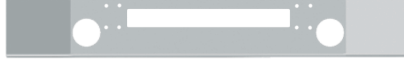

	
HG-2090-12	HG-2010-12
	
HG-2000-12	HG-0090-12
	
HG-0010-12	HG-0000-12

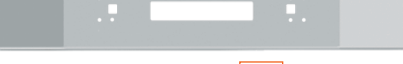
HM

320, 520 CABOVER YEARS 1990 & NEWER

AVAILABLE IN 14" ONLY (-25)

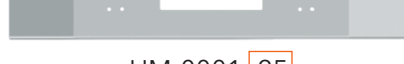
		
HM-1011-25	HM-1012-25	HM-1010-25
		
HM-1001-25	HM-1002-25	HM-1000-25
		
HM-0011-25	HM-0012-25	HM-0010-25
		
HM-0002-25	HM-0000-25	
		
HM-0001-25		

CALL FOR HEATER HOLE OR
NAT. GAS CUTOUTS

PETERBILT BUMPERS

AVAILABLE STYLES FOR PRODUCTS ON THIS PAGE:



Width	End Style Code
12"	15
16"	16
18"	17
*20"	34

* No warranty for 20" wide bumpers

377 WITH 119" BBC, SET BACK AXLE YEARS 1987-1997

HH

377AE SET BACK AXLE YEARS 1990 & OLDER

MOUNTING BRACKETS **NOT** INCLUDED, CHECK 'HN' SERIES PRIOR TO ORDERING
FOG LIGHT BRACKETS INCLUDED WITH ELIGIBLE BUMPERS

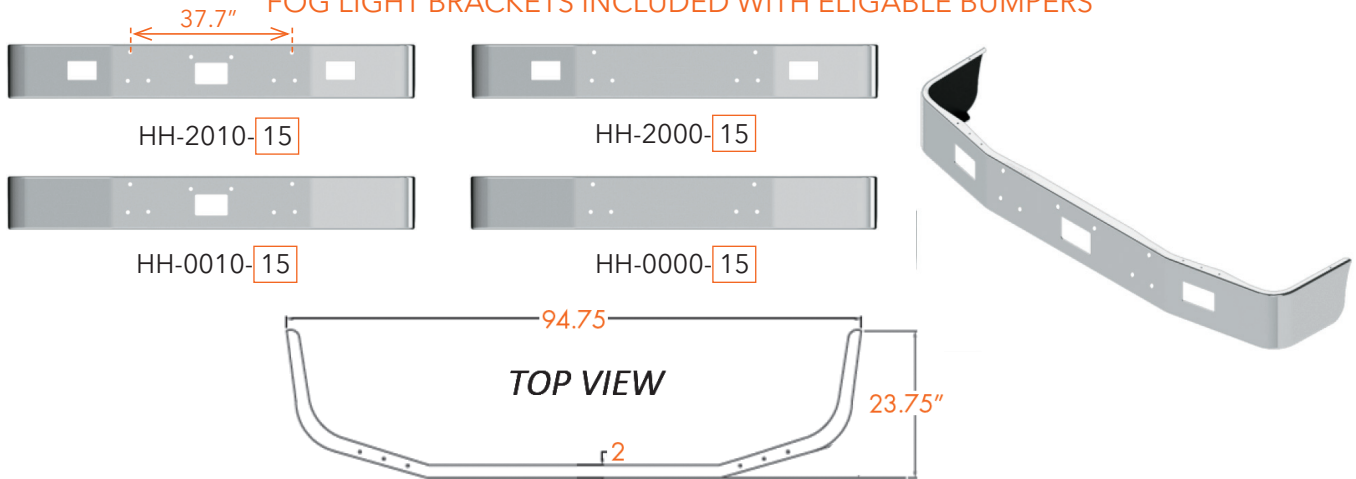

377 WITH 120" BBC / 122" BBC, SET BACK AXLE

HN

385 WITH 120" BBC, SET BACK AXLE YEARS 1997-2007

MOUNTING BRACKETS INCLUDED, CHECK 'HH' SERIES PRIOR TO ORDERING

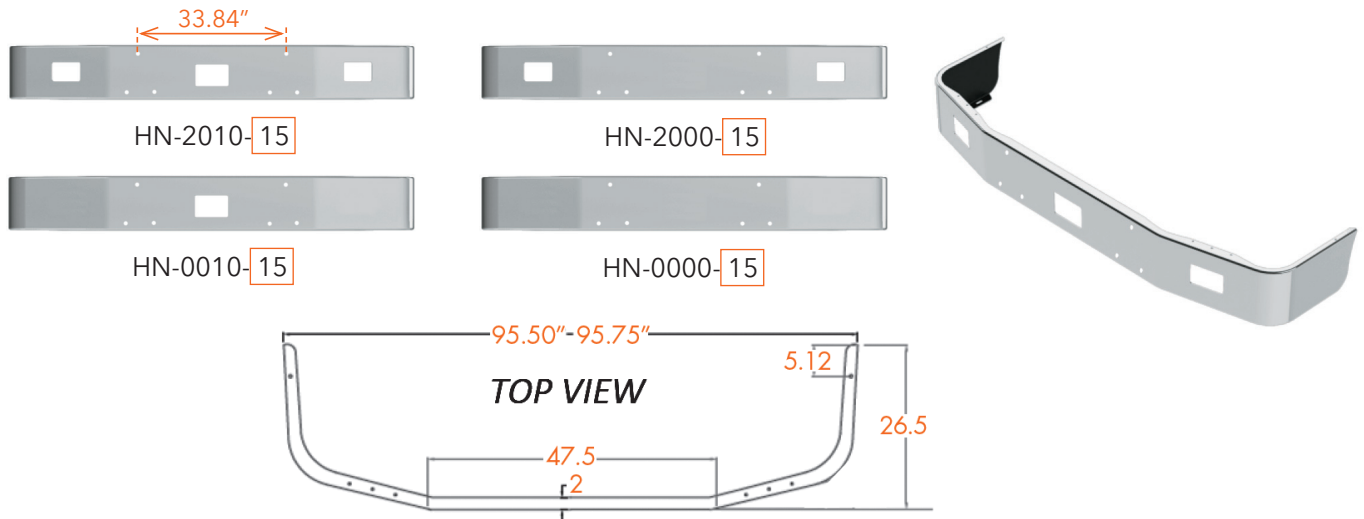

PETERBILT BUMPERS

AVAILABLE STYLES FOR PRODUCTS ON THIS PAGE:



Width	End Style Code
12"	15
16"	16
18"	17
*20"	34

* No warranty for 20" wide bumpers

HL

385 WITH 112" BBC, SET BACK AXLE YEARS 1995-2007

CHECK 'HY' SERIES PRIOR TO ORDERING

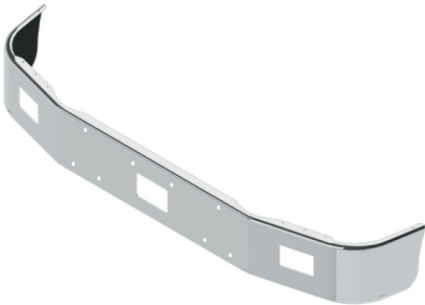

HL-2010-15



HL-2000-15



HL-0010-15



HL-0000-15

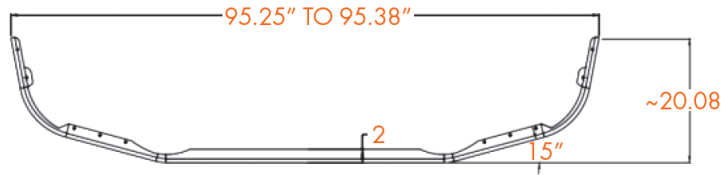

HY

385 WITH 120" BBC, SET BACK AXLE YEARS 1995-2007

CHECK 'HL' SERIES PRIOR TO ORDERING

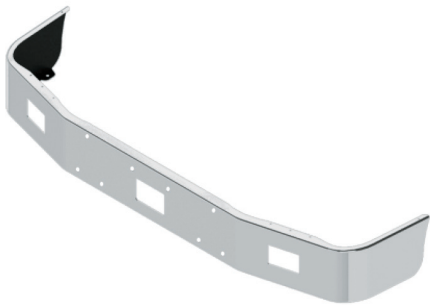

HY-2010-15



HY-2000-15



HY-0010-15



HY-0000-15



PETERBILT BUMPERS

AVAILABLE STYLES FOR PRODUCTS ON THIS PAGE:



Width	End Style Code
12"	15
16"	16
18"	17
*20"	34

* No warranty for 20" wide bumpers

357, 378 SET BACK AXLE YEARS 2005-2007

NOTE LETTERS 'HOD' IN PART NUMBER
CHECK 'HG' SERIES PRIOR TO ORDERING

HOD



HOD-2090-15



HOD-2010-15



HOD-0090-15



HOD-0010-15



HOD-0000-15



HOD-2000-15

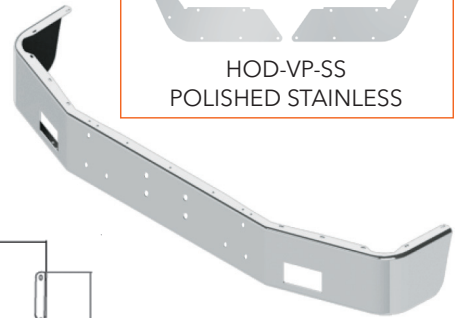
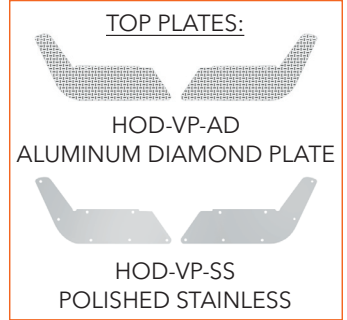
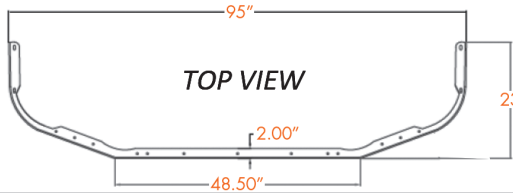

367, 567 SET BACK AXLE YEARS 2007 & NEWER

MOUNTS TO FACTORY BRACKETS

* FACTORY TOP PLATES DO NOT MOUNT TO VCP BUMPER *
(TOP PLATES SOLD SEPARATELY)

HX

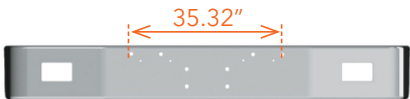

HX-2090-15

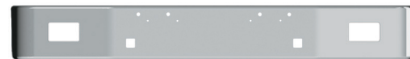

HX-2010-15



HX-0090-15



HX-0010-15

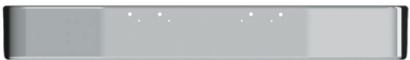

HX-0000-15



HX-2000-15

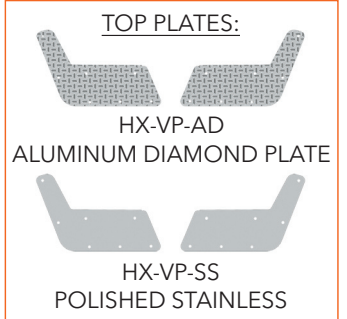

PETERBILT BUMPERS

AVAILABLE STYLES FOR PRODUCTS ON THIS PAGE:

HP, HOF		HT	
Width	End Style Code	Width	End Style Code
13"	18	14"	15
16"	19	16"	16
18"	20	18"	17
20"	35	*20"	34

* No warranty for 20" wide bumpers

HP

330 SET FORWARD AXLE YEARS 1998-2005

12K/14K RATED FRONT AXLE

CHECK 'HOF' SERIES PRIOR TO ORDERING
ONE SET LICENSE PLATE HOLES INCLUDED

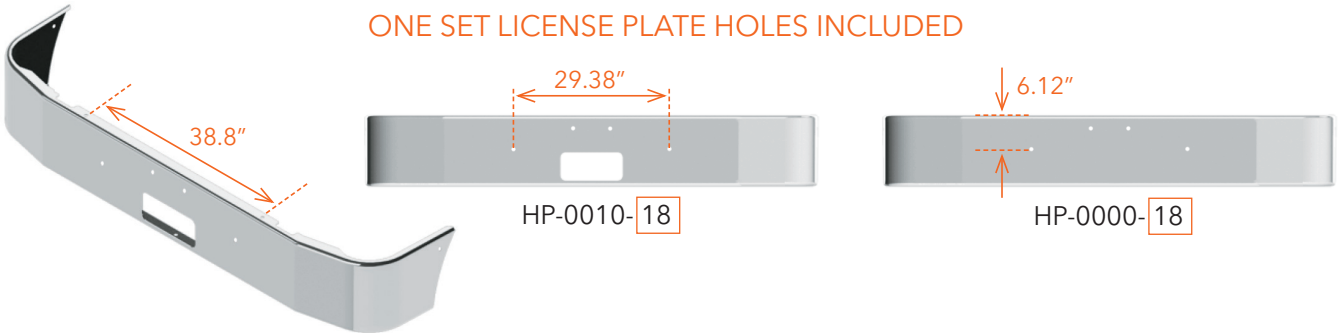

HOF

335HD, 340HD SET FORWARD AXLE YEARS 2006-2014

16K RATED FRONT AXLE

BRACKETS NOT INCLUDED. MOUNTS TO FACTORY BRACKETS.
NOTE LETTERS 'HOF' IN PART NUMBER. CHECK 'HP' SERIES PRIOR TO ORDERING.

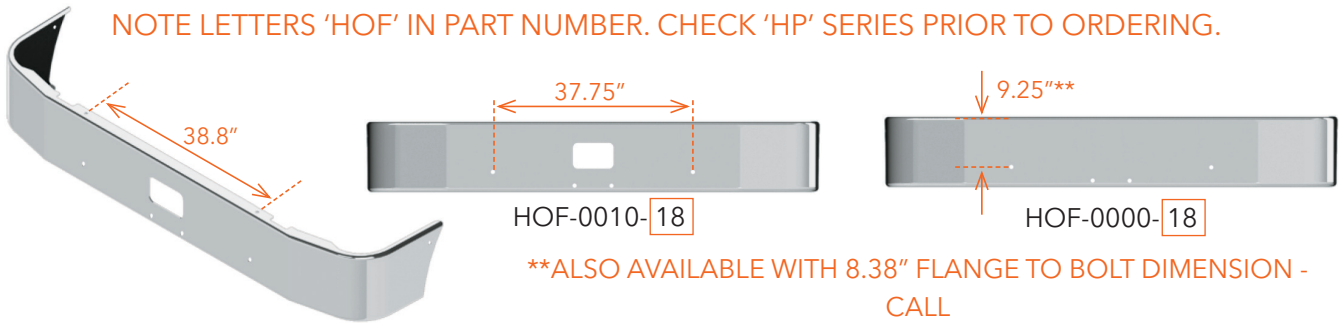

**ALSO AVAILABLE WITH 8.38" FLANGE TO BOLT DIMENSION - CALL

HT

330, 335, 337, 340, 348 SET BACK AXLE YEARS 2006-2014

12K/14K RATED FRONT AXLE

MOUNTING BRACKETS INCLUDED

CHECK 'HOC' SERIES PRIOR TO ORDERING. ONE SET LICENSE PLATE HOLES INCLUDED.

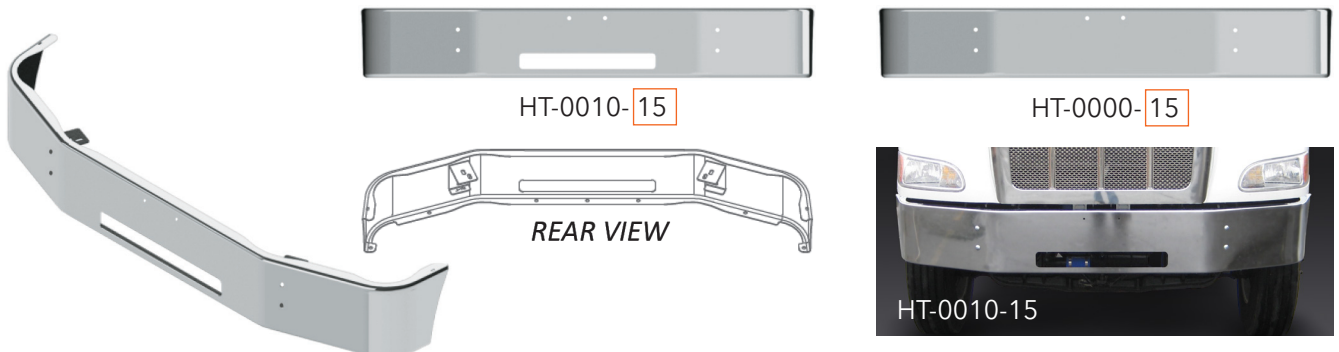

PETERBILT BUMPERS

AVAILABLE STYLES FOR PRODUCTS ON THIS PAGE:

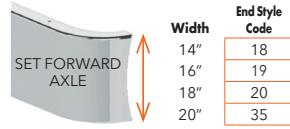

337 SET FORWARD AXLE YEARS 2015 & NEWER
 MOUNTING BRACKETS INCLUDED
 NOTE LETTERS 'HOC' IN PART NUMBER
 CHECK 'HT' SERIES PRIOR TO ORDERING

HOC



HOC-2010-18



HOC-2000-18



HOC-0010-18

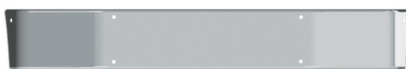

HOC-0000-18

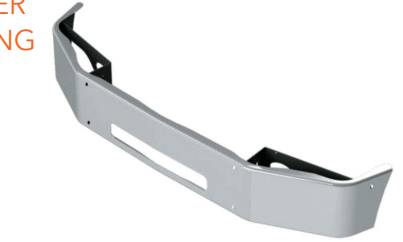
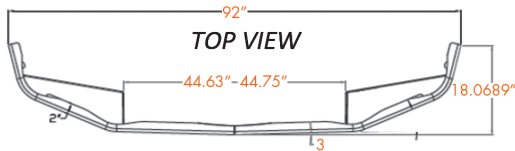

HOC-0010-18

348 SET FORWARD AXLE YEARS 2010 & NEWER
 NOTE LETTERS 'HOE' IN PART NUMBER

HOE



HOE-2010-18

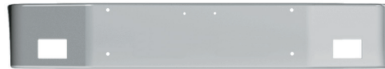

HOE-2000-18



HOE-0010-18



HOE-0000-18

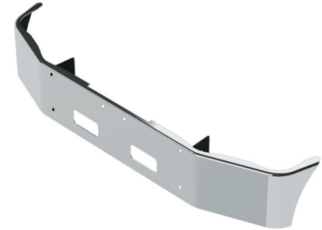
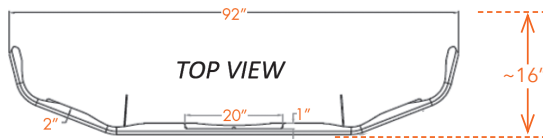

HOE-0010-18

536 & 537 SET FORWARD AXLE YEARS 2021-NEWER
 MOUNTS TO FACTORY BRACKETS FOR STEEL REPLACEMENT
 (SEPARATE BRACKETS REQUIRED TO REPLACE FACTORY URETHANE)

HOG

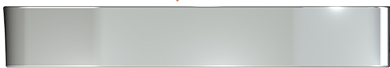

HOG-0000-18



HOG-5001-18



HOG-5000-18



HOG-0001-18

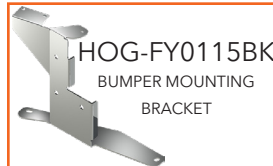

HOG-FY0115BK
 BUMPER MOUNTING
 BRACKET



HOG-5001-18

PETERBILT BUMPERS

AVAILABLE STYLES FOR PRODUCTS ON THIS PAGE:



Width	End Style Code
16"	16
18"	17
20"	34
22"	36

* No warranty for 20" wide bumpers

HR

387 SET BACK AXLE YEARS 1999-2001
MOUNTING BRACKETS INCLUDED
AVAILABLE IN 16" TO 20" WIDTHS ONLY



HR-2210-16



HR-2200-16



HR-2010-16



HR-0210-16



HR-0200-16



HR-0010-16



HR-0210-16

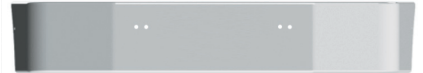
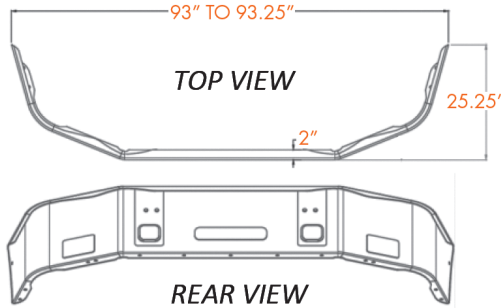

HR-0000-16

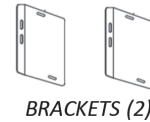

BRACKETS (2)

HS

387 SET BACK AXLE YEARS 2002-2011
MOUNTING BRACKETS INCLUDED
AVAILABLE IN 16" TO 20" WIDTHS ONLY



HS-2210-16



HS-2200-16



HS-2010-16



HS-0210-16



HS-0200-16



HS-0010-16



HS-2210-16

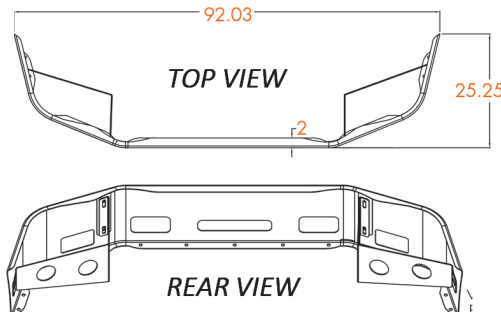

HS-0000-16

PETERBILT BUMPERS

AVAILABLE STYLES FOR PRODUCTS ON THIS PAGE:



Width	End Style Code
13"	15
16"	16
18"	17
*20"	34

SEE DESCRIPTIONS BELOW FOR AVAILABLE WIDTHS

* No warranty for 20" wide bumpers

386 SET BACK AXLE YEARS 2006-2015

REPLACES PLASTIC BUMPERS ONLY

MOUNTING BRACKETS INCLUDED

AVAILABLE IN 16" TO 20" WIDTHS ONLY

HU



HU-2210-16



HU-2010-16

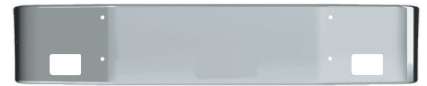

HU-2000-16



HU-0210-16



HU-0010-16



HU-0000-16

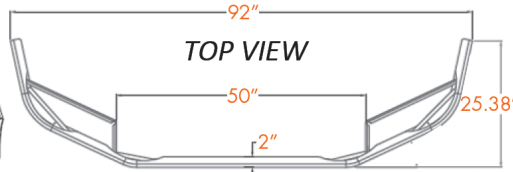
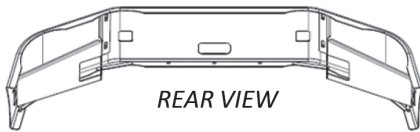

384 SET BACK AXLE YEARS 2008-2015

REPLACES STAINLESS CLAD BUMPERS - MOUNTS TO CLAD BRACKETS

CLAD REPLACEMENT AVAILABLE IN 13" WIDTH ONLY

PLASTIC REPLACEMENT REQUIRES MOUNTING BRACKETS:

HW0115BK (13") OR HW0116BK (16")

HW



HW-2011-15

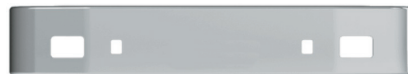

HW-2010-15

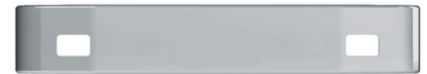

HW-2000-15

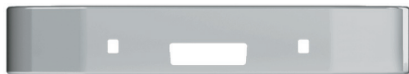

HW-0011-15

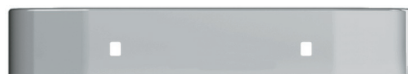

HW-0010-15

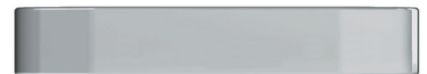

HW-0000-15

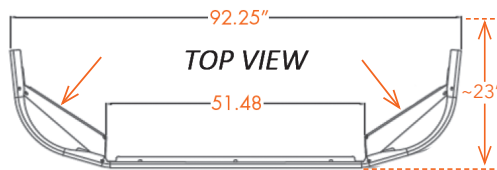
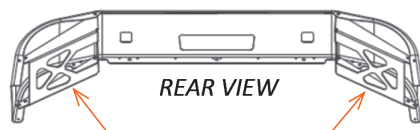

Brackets only for plastic bumper replacement.
Sold separately.

PETERBILT BUMPERS

AVAILABLE STYLES FOR PRODUCTS ON THIS PAGE:

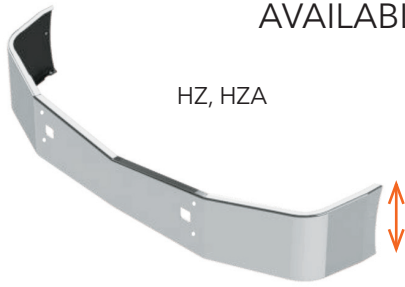

Width	End Style Code
16.5"	16Y
18"	17Y



Width	End Style Code
16"	16
18"	17
*20"	34

* No warranty for 20" wide bumpers

HZ

579 SET BACK AXLE YEARS 2012-2020
MOUNTING BRACKETS INCLUDED



HZ-5110-16Y-V4



HZ-5110-16Y



HZ-5100-16Y



HZ-0110-16Y-V4



HZ-0110-16Y



HZ-5010-16Y



HZ-0110-16Y

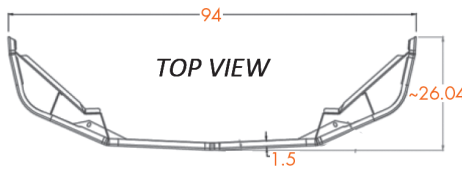

TOP VIEW

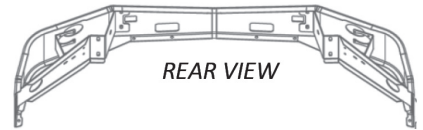

REAR VIEW

HOA

587 SET BACK AXLE YEARS 2012 & NEWER
NOTE LETTERS 'HOA' IN PART NUMBER. MOUNTING BRACKETS INCLUDED.



HOA-5110-16



HOA-2110-16



HOA-0110-16



HOA-5100-16



HOA-2100-16

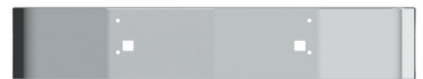

HOA-0010-16



HOA-0100-16



HOA-0210-16



HOA-0000-16



HOA-0010-16

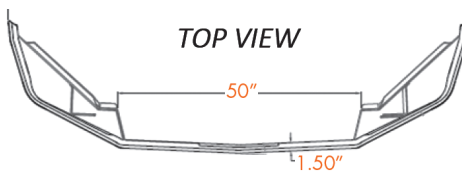

TOP VIEW

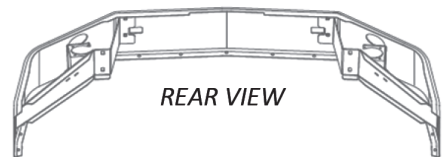

REAR VIEW

PETERBILT BUMPERS

HZA

579 GEN II SET BACKAXLE

YEARS 2021 & NEWER
MOUNTING BRACKETS INCLUDED
SIMILAR OPTIONS AS 'HZ' SERIES ON PREVIOUS
PAGE



HZA-0010-16Y



HZA-0000-16Y



HZA-5010-16Y



HZA-5010-16Y-V4
(GEN II W/OEM FOGS)



HZA-0010-16Y-V4

579 GEN II SET BACKAXLE

YEARS 2021 & NEWER
GRILL INSERTS
(SET OF 2)

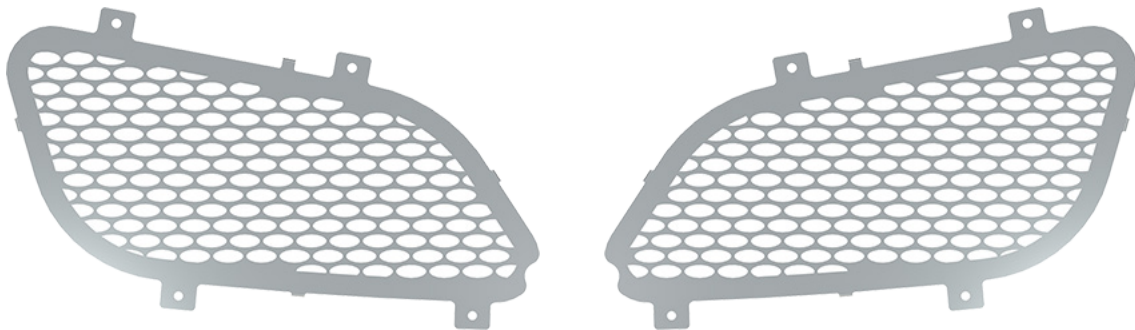

VP100200

STERLING BUMPERS

AVAILABLE STYLES FOR PRODUCTS ON THIS PAGE:



SET FORWARD AXLE

Width	End Style Code
13"	18
16"	19
18"	20
20"	35

LT7501 SET FORWARD AXLE YEARS 2000-2009
 ONE SET OF UPPER LICENSE PLATE HOLES COME STANDARD
 3/4" SPACERS INCLUDED

NA



NA-2010-18



NA-2000-18



NA-0010-18



NA-0000-18

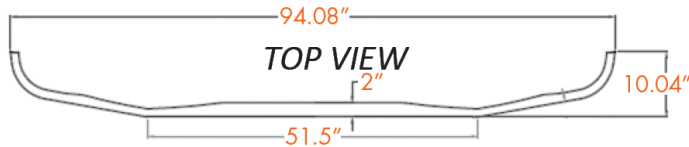
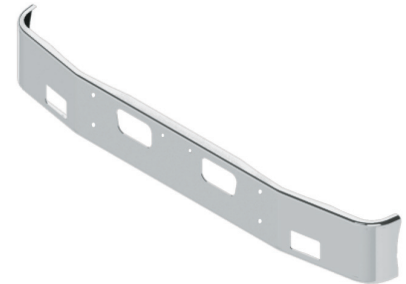

ACTERRA SET FORWARD AXLE YEARS 2000-2006
 MOUNTS TO OEM BRACKETS

NB



NB-2200-18



NB-2000-18



NB-0200-18



NB-0000-18

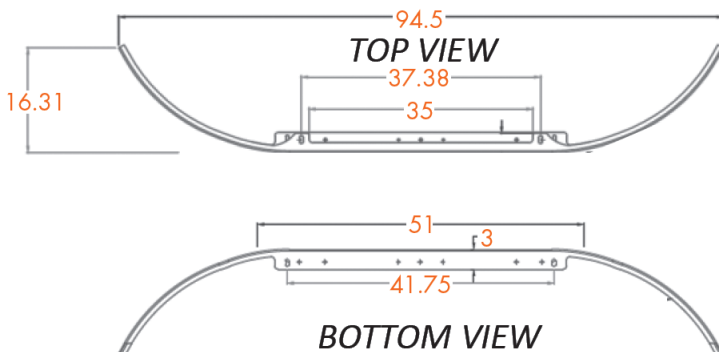

STERLING BUMPERS

AVAILABLE STYLES FOR PRODUCTS ON THIS PAGE:

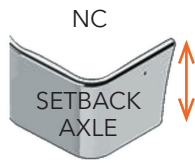

Width	End Style Code
12"	15
16"	16
18"	17
*20"	34

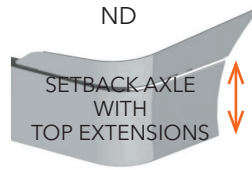

Width	End Style Code
12"	15X
16"	16X
18"	17X
*20"	34X

* No warranty for 20" wide bumpers

NC

STERLING LT9500, LT9513, FORD L-SERIES

YEARS 1996-2009

MOUNTING BRACKETS INCLUDED. ONE SET LICENSE PLATE HOLES STANDARD.

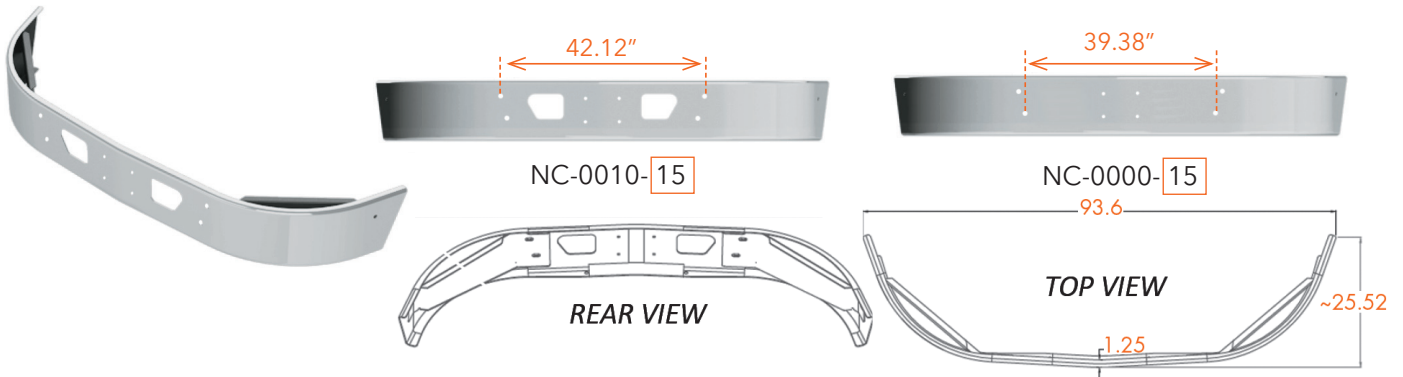

Add "P" to the end of our part number for a black powder coated bumper

ND

STERLING AT9500 YEARS 1996-2009

MOUNTING BRACKETS INCLUDED

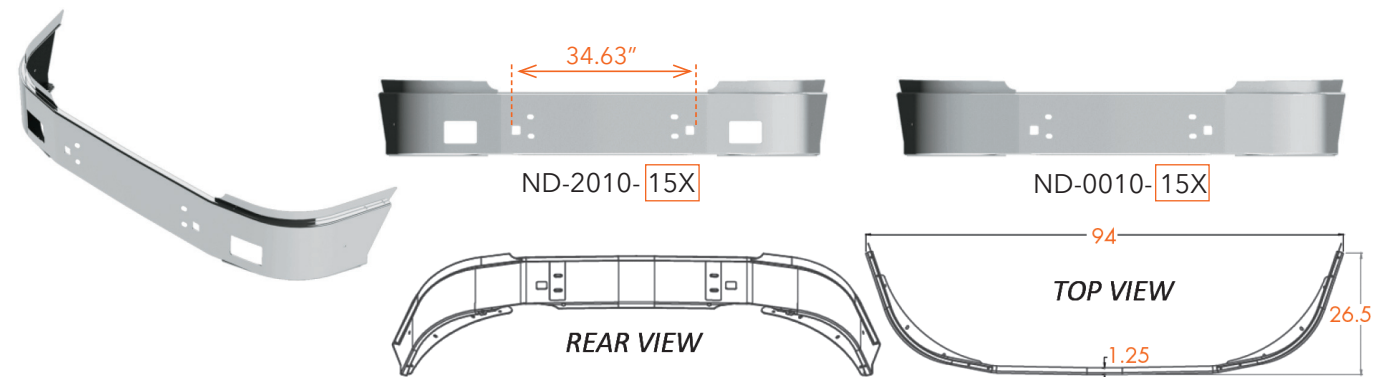

Add "P" to the end of our part number for a black powder coated bumper

VOLVO BUMPERS

AVAILABLE STYLES FOR PRODUCTS ON THIS PAGE:



Width	End Style Code
12"	15
16"	16
18"	17
*20"	34

LA = 13"

* No warranty for 20" wide bumpers

WA, WIA SET BACK AXLE YEARS 1988-1997

MOUNTING BRACKETS INCLUDED

LA

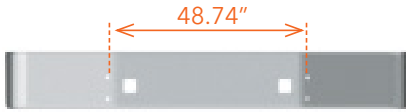

LG-0010-15



LG-0000-15

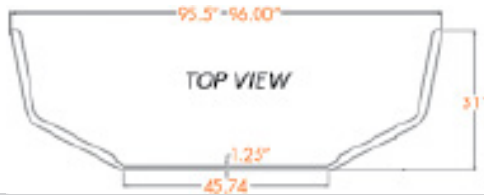

VNM SET BACK AXLE YEARS 1998-2003

MOUNTING BRACKETS INCLUDED

LD



LD-0011-15

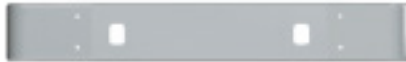

LD-0010-15



LD-0001-15



LD-0000-15

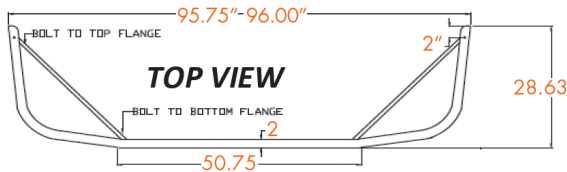

VNM SET BACK AXLE YEARS 2004-2017

MOUNTING BRACKETS INCLUDED

LG



LG-5011-15



LG-0011-15

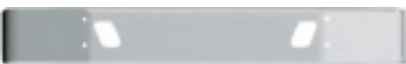

LG-0010-15

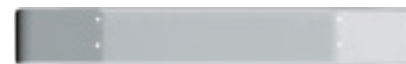

LG-0000-15

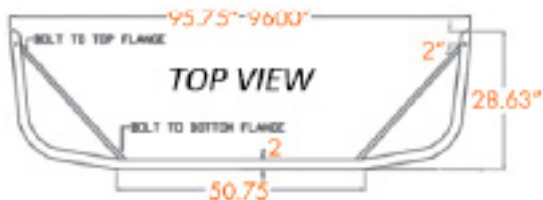

VOLVO BUMPERS

AVAILABLE STYLES FOR PRODUCTS ON THIS PAGE:

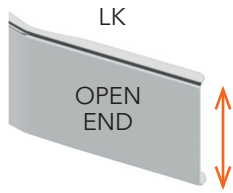

Width	End Style Code
12"	12
14"	25
16"	13
18"	14
20"	61

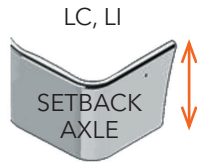

Width	End Style Code
13"	15
16"	16
18"	17
*20"	34

'LI' ONLY AVAILABLE IN - 17 & 34

* No warranty for 20" wide bumpers

LK

WG DAYCAB SET FORWARD AXLE YEARS 1991-2001

SEE 'LC' SERIES FOR NON-DAYCAB

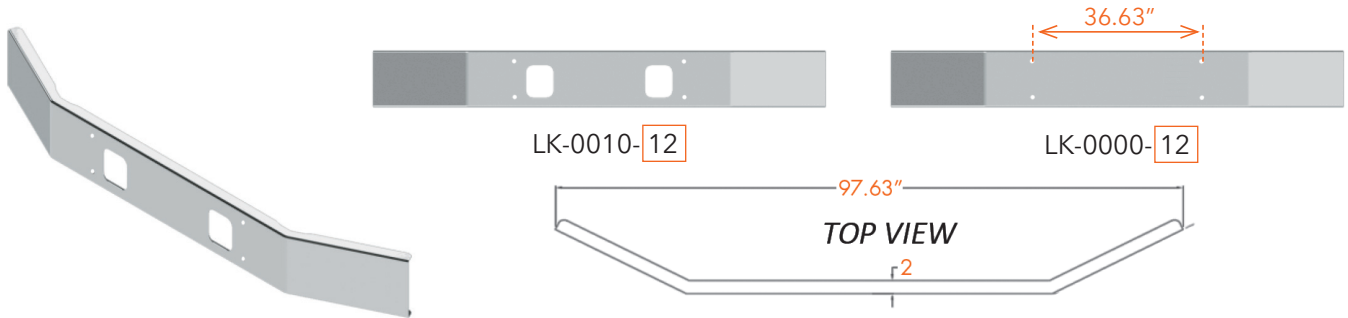

LC

WG SET BACK AXLE YEARS 1991-2001

MOUNTING BRACKETS INCLUDED

SEE 'LK' SERIES FOR DAYCAB

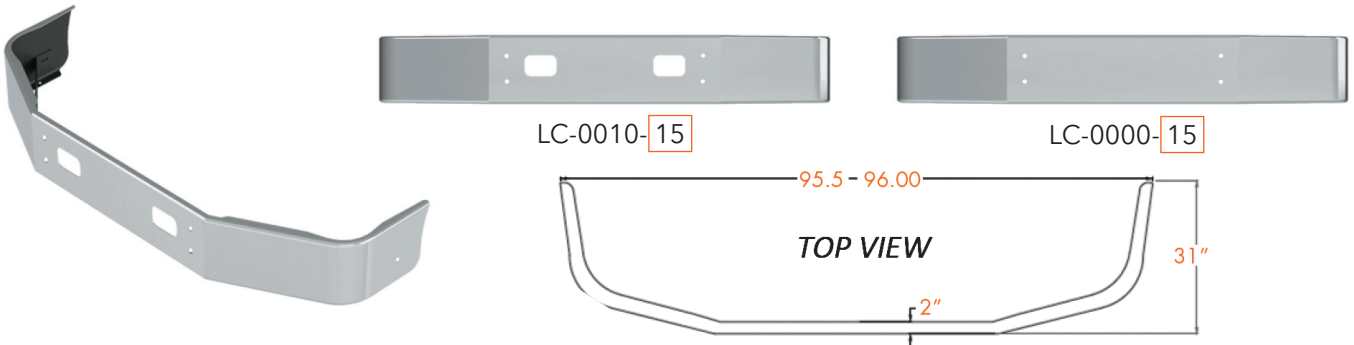

LI

VT SERIES SET BACK AXLE YEARS 2006-2008

NOTE LETTERS 'LI' IN PART NUMBER

ONLY AVAILABLE IN 18" AND 20" WIDTHS

ONE SET UPPER LICENSE PLATE HOLES COME STANDARD



LI-5010-17

LI-0010-17



LI-5010-17

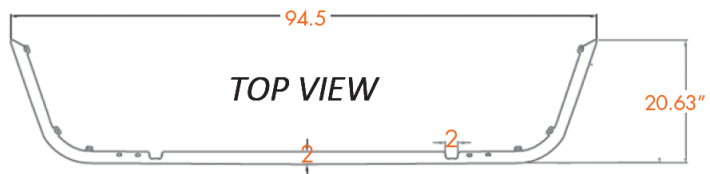

VOLVO BUMPERS

AVAILABLE STYLES FOR PRODUCTS ON THIS PAGE:



Width	End Style Code
16"	02
18"	03
20"	31
22"	32

VOLVO WHITE WCA YEARS 1987-2001

LF

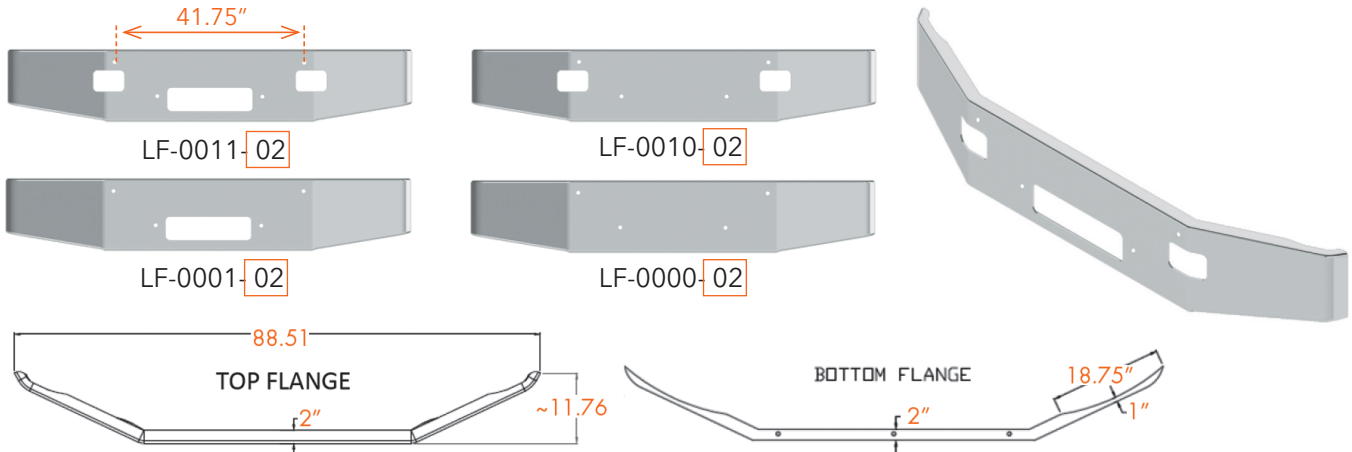

41.75"

LF-0011-02

LF-0010-02

LF-0001-02

LF-0000-02

88.51

TOP FLANGE

2"

~11.76

BOTTOM FLANGE

2"

18.75"

1"

VHD SERIES SET FORWARD AXLE YEARS 2005-2021

MOUNTING BRACKETS AND BLACK POWDER COATED GRILLE FILLER INCLUDED
 NOT AVAILABLE WITHOUT VENT HOLES
 FITS 14,600LB FRONT AXLE ONLY

LM



LM-2011-02

LM-0011-02

LM-0011-02

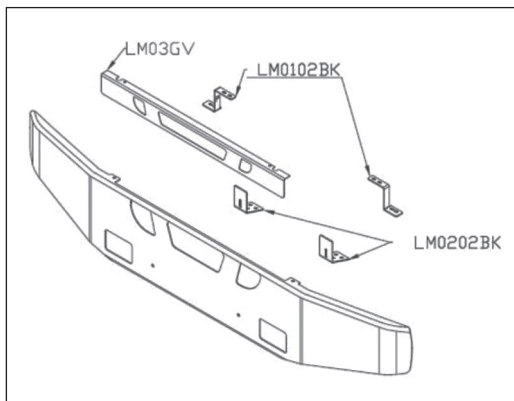

OPTIONAL STAINLESS GRILLE FILLER:

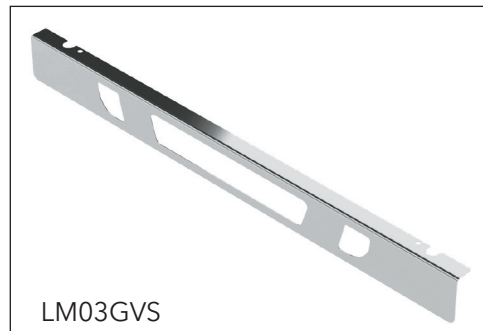

VOLVO BUMPERS

AVAILABLE STYLES FOR PRODUCTS ON THIS PAGE:



Width	End Style Code
12"-13"	15 ← LB = 13" / LE = 12"
16"	16
18"	17
*20"	34

* No warranty for 20" wide bumpers

LB

VNL SET BACK AXLE YEARS 1996-2003

REPLACES PLASTIC/FIBERGLASS BUMPERS ONLY

MOUNTING BRACKETS INCLUDED

SEE 'LE' SERIES FOR REPLACING STAINLESS CLAD BUMPERS

MUST BE 16" (16) FOR FOG LIGHT OPTIONS

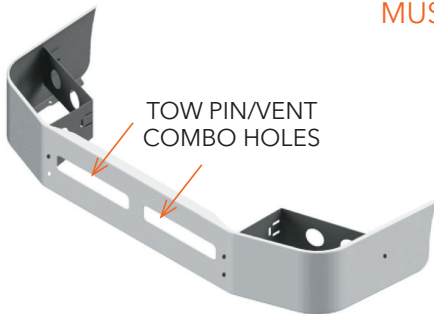

LB-0010-15

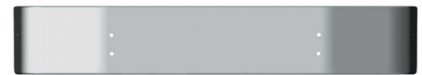

LB-0000-15



LB-4010-16



LB-2010-16



LB-0010-16

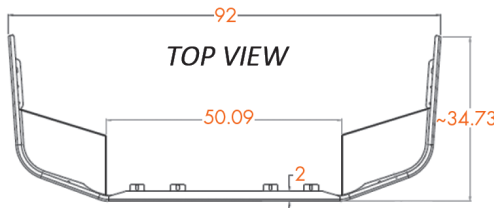

TOP VIEW



REAR VIEW

LE

VNL SET BACK AXLE YEARS 1996-2003

REPLACES STAINLESS CLAD BUMPERS ONLY

MOUNTING BRACKETS INCLUDED

SEE 'LB' SERIES FOR REPLACING PLASTIC/FIBERGLASS BUMPERS

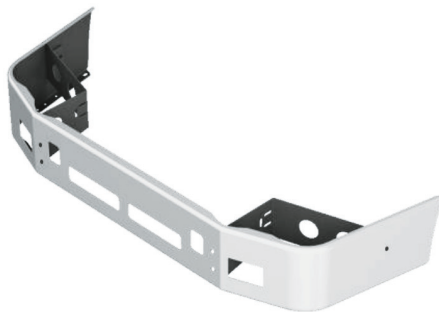

LE-2011-15



LE-2010-15



LE-0011-15



LE-0010-15



LE-2011-15

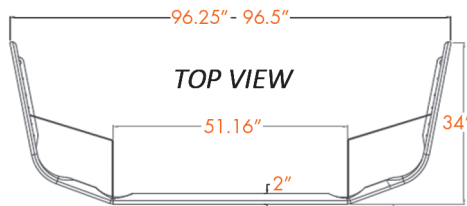

TOP VIEW

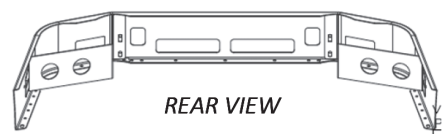

REAR VIEW

VOLVO BUMPERS

AVAILABLE STYLES FOR PRODUCTS ON THIS PAGE:



Width	End Style Code
14"	15
16"	16
18"	17
*20"	34

* No warranty for 20" wide bumpers

VNL SET BACK AXLE YEARS 2004-2017 MOUNTING BRACKETS INCLUDED

LH



LH-5011-15
OEM fog lights, tow pins, vent holes



LH-2011-15
Rectangular fog lights, tow pins, vent holes



LH-5010-15
OEM fog lights, tow pin holes

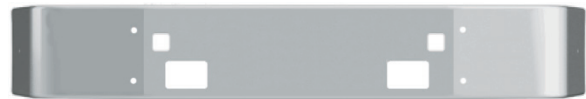

LH-2010-15
Rectangular fog lights, tow pin holes



LH-0011-15
Tow pin holes, vent hole

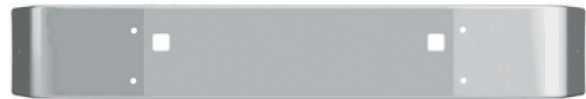

LH-0010-15
Tow pin holes



LH-0000-15
Mounting bolts only

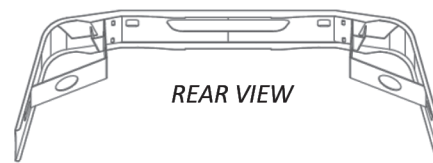
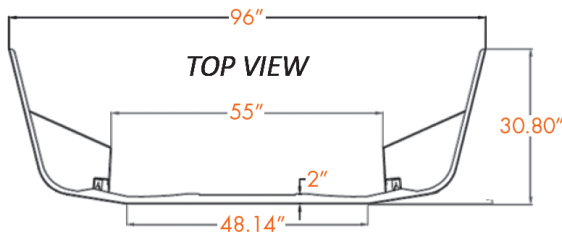

VOLVO BUMPERS

AVAILABLE STYLES FOR PRODUCTS ON THIS PAGE:



Width	End Style Code
14"	15
16"	16
18"	17
*20"	34

* No warranty for 20" wide bumpers

LJ

VNR SET BACK AXLE YEARS 2018 & NEWER MOUNTING BRACKETS INCLUDED



LJ-5011-15



LJ-5010-15



LJ-5001-15



LJ-0011-15

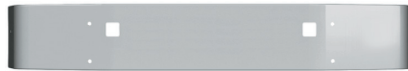

LJ-0010-15

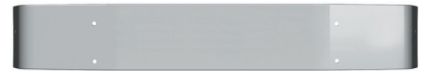

LJ-0000-15

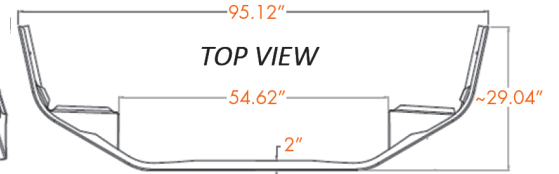
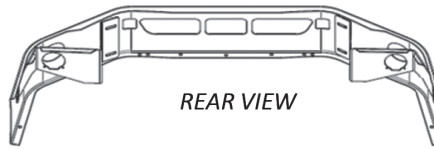

LL

VNL SET BACK AXLE YEARS 2018 & NEWER MOUNTING BRACKETS INCLUDED



LL-5011-15



LL-5010-15



LL-5001-15



LL-0011-15



LL-0010-15



LL-0000-15

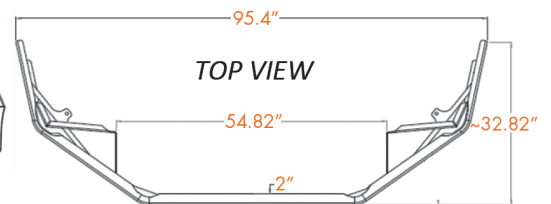
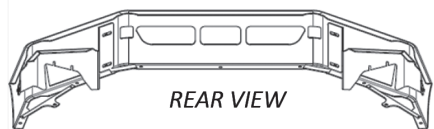

WESTERN STAR BUMPERS

EXAMPLE STYLES FOR PRODUCTS ON THIS PAGE:

Width	End Style Code	Width	End Style Code	Width	End Style Code
12"	01	12"	09	12"	04
16"	02	16"	10	16"	05
18"	03	18"	11	18"	06
20"	31	20"	51	20"	41
22"	32	22"	52	22"	42

CABOVER YEARS 1977-1980

NOTE LETTERS 'IA' IN PART NUMBER
NOT AVAILABLE IN 12" WIDTH

IA



IA-1110-02

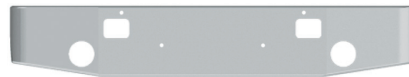

IA-1100-02

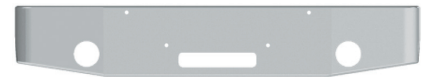

IA-1010-02



IA-0110-02

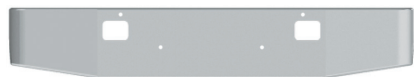

IA-0100-02

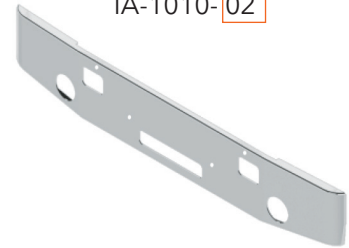

IA-0010-02



IA-0000-02

CONVENTIONAL YEARS 1967-1984

NOTE LETTERS 'IB' IN PART NUMBER

IB



IB-1010-02

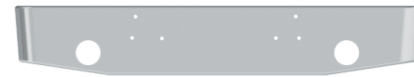

IB-1000-02

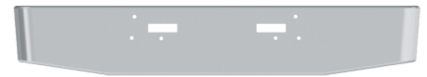

IB-0010-02

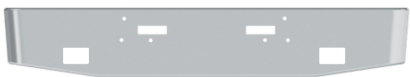

IB-2010-02



IB-0000-02

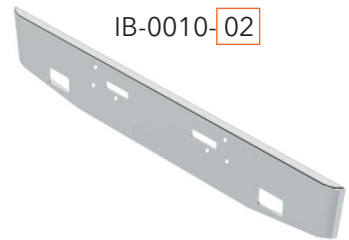

CONVENTIONAL YEARS 1985-1988

NOTE LETTERS 'IF' IN PART NUMBER

IF

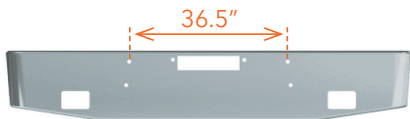

IF-2010-02



IF-2000-02



IF-0010-02





IF-0000-02

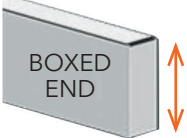

WESTERN STAR BUMPERS

EXAMPLE STYLES FOR PRODUCTS ON THIS PAGE:

	Width	End Style Code		Width	End Style Code		Width	End Style Code
 <p>TAPER ROLLED END</p>	12"	01	 <p>BOXED END</p>	12"	09	 <p>SQUARE ROLLED END</p>	12"	04
	16"	02		16"	10		16"	05
	18"	03		18"	11		18"	06
	20"	31		20"	51		20"	41
	22"	32		22"	52		22"	42

IC 4900SF, 4900EX, CONSTELLATION, LOWMAXX, HERITAGE YEARS 1989-2007 AND SIMILAR CHASSIS. NOTE LETTERS 'IC' IN PART NUMBER.



IH 4900SF YEARS 2008 & NEWER NOT AVAILABLE IN 12" WIDTH. NOTE LETTERS 'IH' IN PART NUMBER.

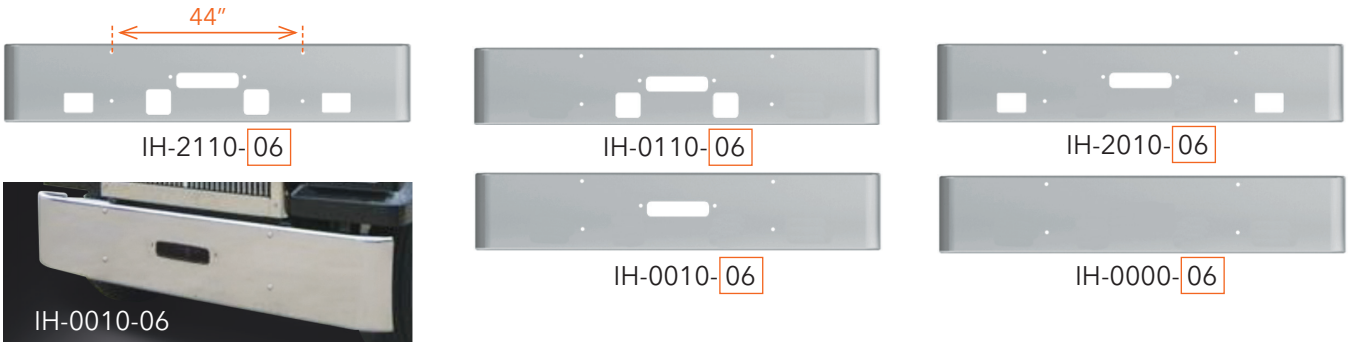

IM 4700SF YEARS 2008 & NEWER NOT AVAILABLE IN 12" WIDTH. NOTE LETTERS 'IM' IN PART NUMBER.

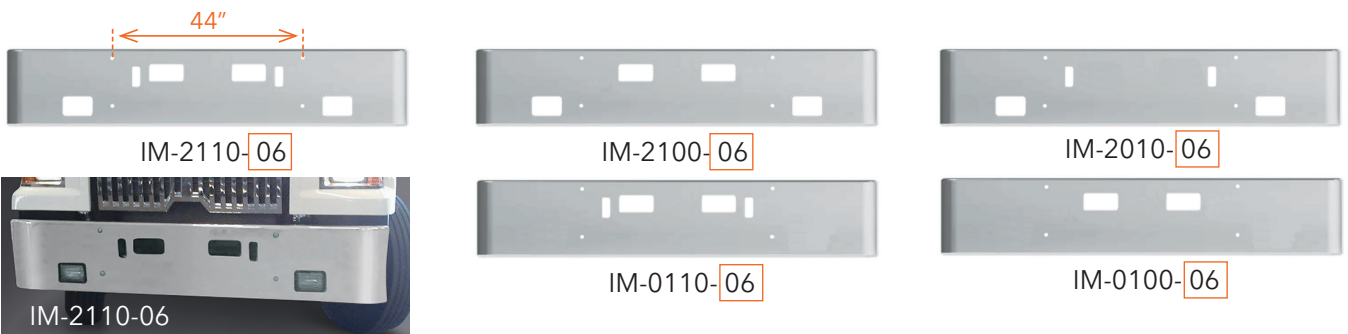

WESTERN STAR BUMPERS

AVAILABLE STYLES FOR PRODUCTS ON THIS PAGE:



Width	End Style Code
14"	44
16"	45
18"	46
*20"	47
*22"	48

* No warranty for 20" or 22" wide bumpers

4900SA YEARS 1989-2007 NOTE LETTERS 'II' IN PART NUMBER

II

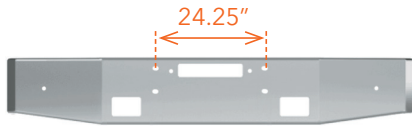

II-2010-44



II-0010-44



II-2000-44



II-0000-44

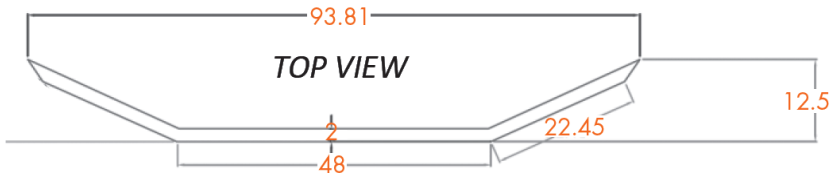
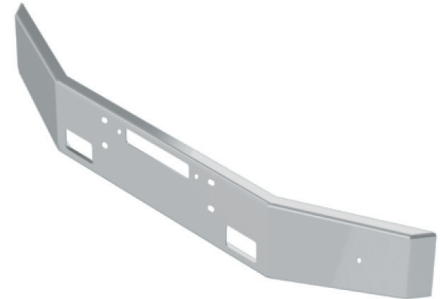

II-0010-44

4900SA YEARS 2008 & NEWER NOTE LETTERS 'IJ' IN PART NUMBER ALSO CHECK 'IK' AND 'IL' SERIES PRIOR TO ORDERING

IJ

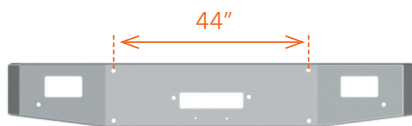

IJ-2010-44

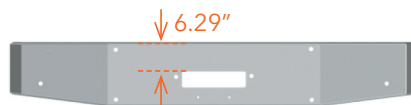

IJ-0010-44



IJ-2000-44



IJ-0000-44

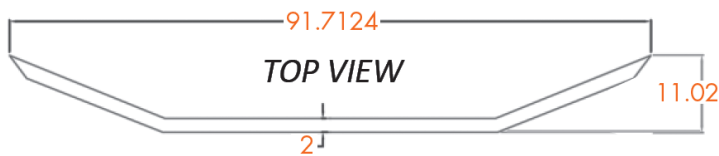
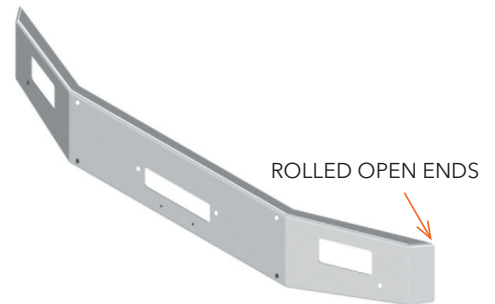

IJ-2010-44

WESTERN STAR BUMPERS

AVAILABLE STYLES FOR PRODUCTS ON THIS PAGE:

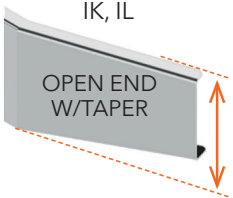
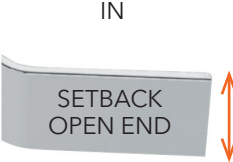
 <p>IK, IL</p> <p>OPEN END W/TAPER</p>	<p>Width</p> <p>14"</p> <p>16"</p> <p>18"</p> <p>*20"</p> <p>*22"</p>	<p>End Style Code</p> <table border="1"> <tr><td>44</td></tr> <tr><td>45</td></tr> <tr><td>46</td></tr> <tr><td>47</td></tr> <tr><td>48</td></tr> </table>	44	45	46	47	48	 <p>IN</p> <p>SETBACK OPEN END</p>	<p>Width</p> <p>14"</p> <p>16"</p> <p>18"</p>	<p>End Style Code</p> <table border="1"> <tr><td>15</td></tr> <tr><td>16</td></tr> <tr><td>17</td></tr> </table>	15	16	17
			44										
			45										
			46										
			47										
48													
15													
16													
17													

* No warranty for 20" or 22" wide bumpers



IK

4900SA YEARS 2008 & NEWER

NOTE LETTERS 'IK' IN PART NUMBER

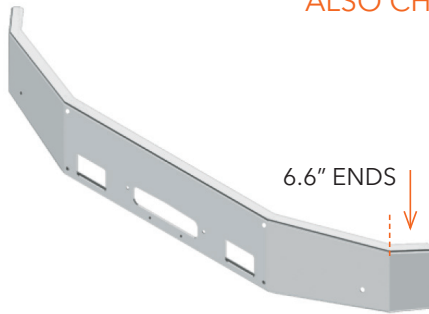
ALSO CHECK 'IJ' AND 'IL' SERIES PRIOR TO ORDERING

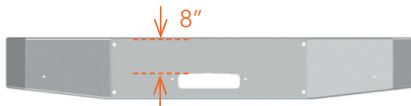
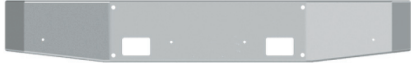

 <p>IK-2010-44</p>	 <p>IK-0010-44</p>
 <p>IK-2000-44</p>	 <p>IK-0000-44</p>





IL

4900SA YEARS 2008 & NEWER

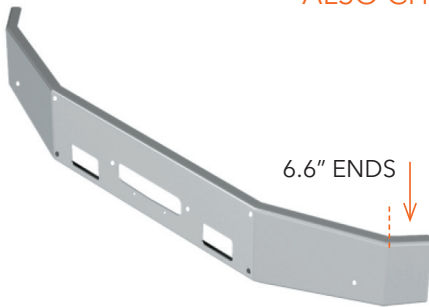
NOTE LETTERS 'IL' IN PART NUMBER

ALSO CHECK 'IJ' AND 'IK' SERIES PRIOR TO ORDERING







 <p>IL-2010-44</p>	 <p>IL-0010-44</p>
 <p>IL-2000-44</p>	 <p>IL-0000-44</p>

IN

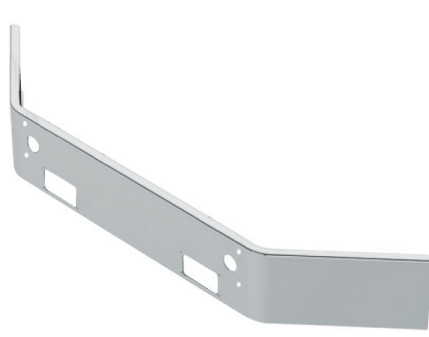
4700SB YEARS 2013 & NEWER

NOTE LETTERS 'IN' IN PART NUMBER



 <p>IN-2010-15</p>	 <p>IN-0010-15</p>
 <p>IN-0000-15</p>	 <p>IN-0010-15</p>

WESTERN STAR BUMPERS

AVAILABLE STYLES FOR PRODUCTS ON THIS PAGE:

Width	End Style Code
16"	708
18"	709
*20"	711

5700XE YEARS 2015 & NEWER

IO

ONLY FITS STANDARD WIDTH FRAMES WITH ~1400 SQ. INCH RADIATORS
MOUNTING BRACKETS AND TOP FLANGE STAINLESS EXTENSIONS INCLUDED
NOTE LETTERS 'IO' IN PART NUMBER

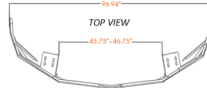
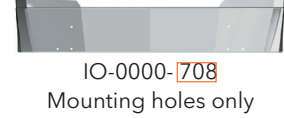
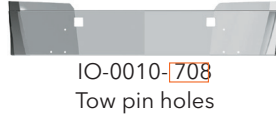
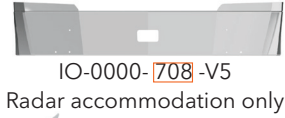
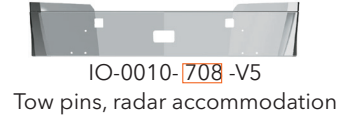
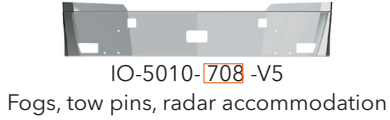

Width	End Style Code	AVAILABLE STYLES FOR PRODUCTS IN THIS SECTION:	Width	End Style Code	Width	End Style Code	
14"		<p>IR, IS OPEN END W/TAPER</p>	16"	05	<p>IQ, IT SQUARE ROLLED END</p>	12"	01
16"	45		18"	06		16"	02
18"	46		20"	41		18"	03
*20"	47		22"	42		20"	31
*22"	48					22"	32

* No warranty for 20" or 22" wide bumpers

47X SET FORWARD AXLE YEARS 2022-NEWER

IQ

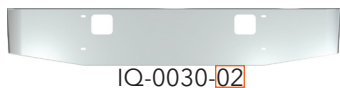
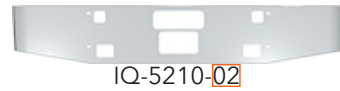
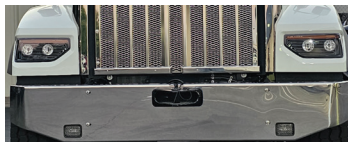

49X SETBACK AXLE SD YEARS 2021-NEWER

IR

Only (-45) End Style Mounts to Factory Brackets

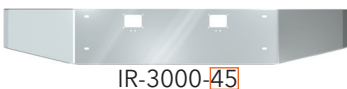
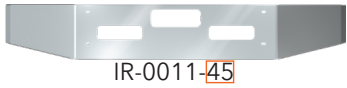

47X SETBACK AXLE YEARS 2022-NEWER

IS

Only (-45) End Style Mounts to Factory Brackets

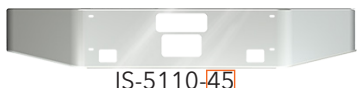

WESTERN STAR BUMPERS

IT

Width	End Style Code	IQ, IT
16"	92	TAPER HAND FORM
18"	03	
20"	31	
22"	32	

AVAILABLE STYLES FOR THIS SERIES ALSO ON PREVIOUS PAGE

49X SET FORWARD AXLE YEARS 2021-NEWER

* No warranty for 20" or 22" wide bumpers



IT-0000-92



IT-0220-92



IT

AMERICAN EAGLE BOXED END

WITH 8" EARS

Width	End Style Code
16"	55
18"	56
20"	57
22"	58



IT-5330-92



IT-5221-92

AVAILABLE STYLES FOR PRODUCTS IN THIS SECTION:

Width	End Style Code
16"	708
18"	709
*20"	711

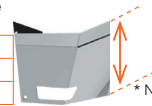

* No warranty for 20" wide bumpers

IP

5700XE YEARS 2015 & NEWER
 ONLY FITS WIDER FRAMES WITH HIGH-CAPACITY RADIATOR MOUNTING BRACKETS AND TOP FLANGE STAINLESS EXTENSIONS INCLUDED
 NOTE LETTERS 'IP' IN PART NUMBER



IP-0000-708
 Mounting holes only



IP-0010-708
 With Tow Pin Holes

VALLEY CHROME PLATING

WHITE BUMPERS

AVAILABLE STYLES FOR PRODUCTS ON THIS PAGE:

KA			KA			KB		
	Width	End Style Code		Width	End Style Code		Bumper Length	End Style Code
TAPER ROLLED END	16"	02	SQUARE ROLLED END	16"	05	WRAP AROUND	12"	22
	18"	03		18"	06		88"	22-88"
	20"	31		20"	41			
	22"	32		22"	42			

KA

ROAD BOSS 2, ROAD COMMANDER 2

YEARS 1972-1983

NOT AVAILABLE IN 12" WIDTH

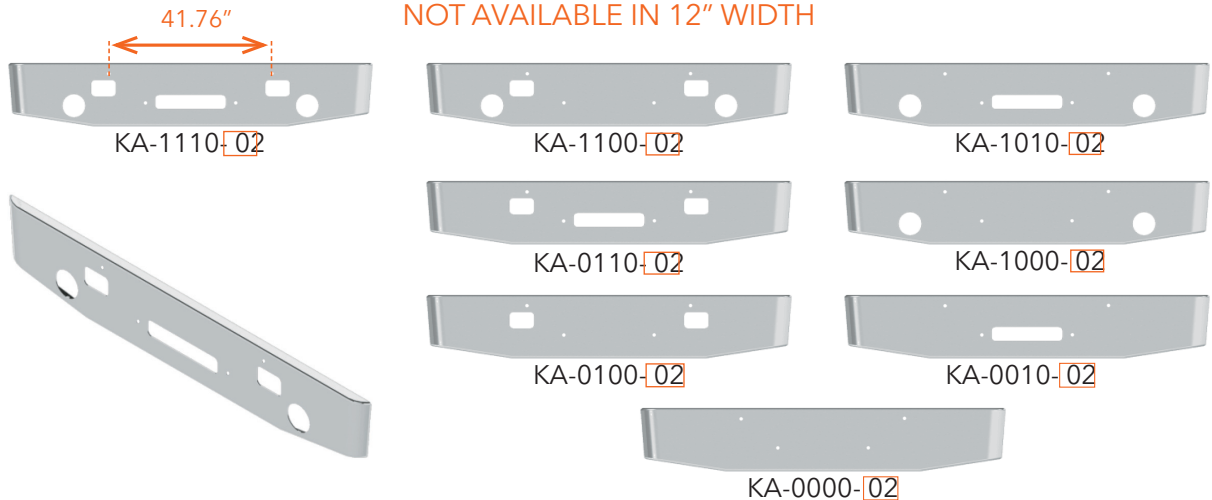

KB

XPEDITOR YEARS 2003-2010

NOTE OUTSIDE SHAPE & BOLT PATTERN PRIOR TO ORDERING

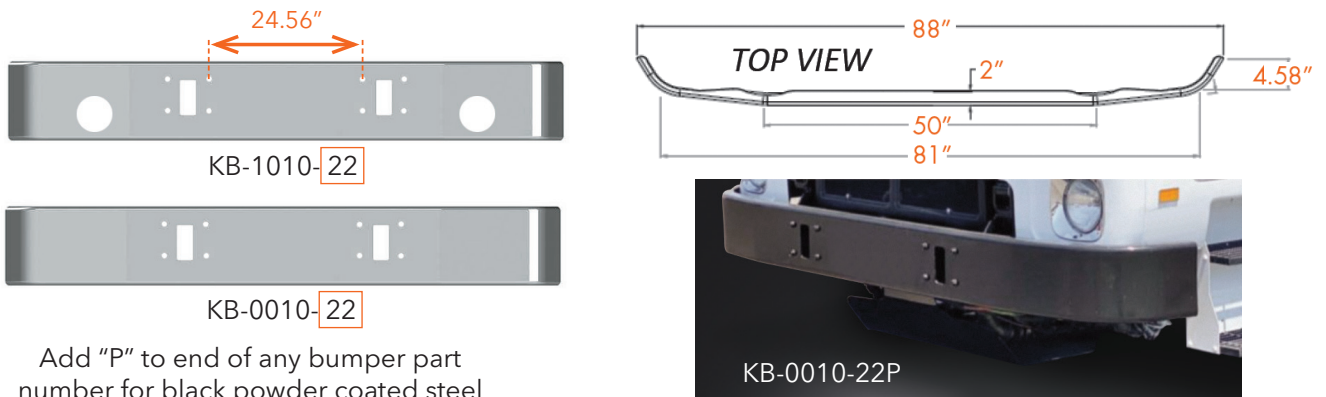

Add "P" to end of any bumper part number for black powder coated steel

"UNIVERSAL" MOUNT BLANK BUMPERS

EXAMPLE STYLES FOR PRODUCTS ON THIS PAGE:

Style	Width	End Style Code
TAPER ROLLED END	16"	02
	18"	03
	20"	31
	22"	32
SQUARE ROLLED END	16"	05
	18"	06
	20"	41
	22"	42
SQUARE BOXED END	16"	10
	18"	11
	20"	51
	22"	52
ROADRUNNER	16"	112
	18"	113
	20"	114
	22"	115
AMERICAN EAGLE ROLLED END	16"	65
	18"	66
	20"	67
	22"	68
AMERICAN EAGLE BOXED END	16"	55
	18"	56
	20"	57
	22"	58

SEE MORE BUMPER STYLES ON PAGE 7

MULTIPLE MAKE & MODEL FIT

NOTE LETTERS 'GO' IN PART NUMBER

EXAMPLE PARTS:

GO

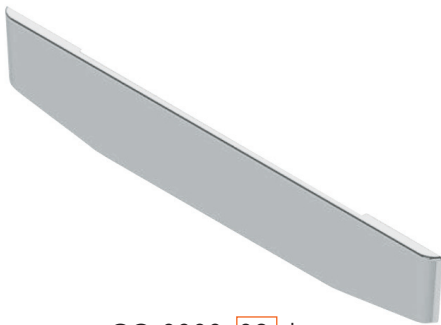

GO-0000-02 chrome
GO-0000-02S stainless

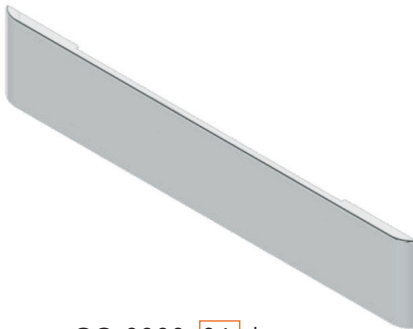

GO-0000-06 chrome
GO-0000-06S stainless

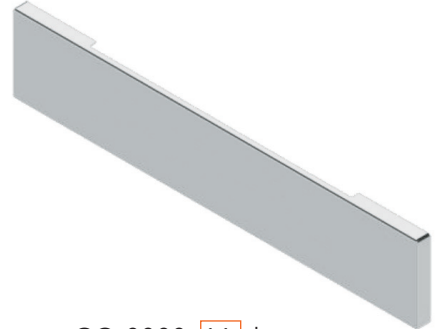

GO-0000-11 chrome
GO-0000-11S stainless

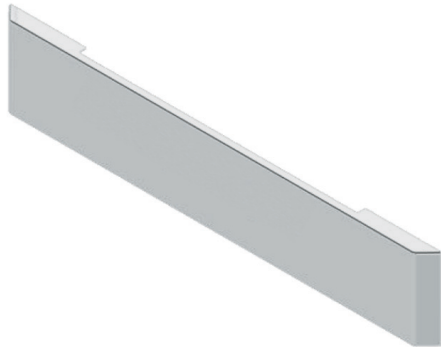

GO-0000-113 chrome
GO-0000-113S stainless

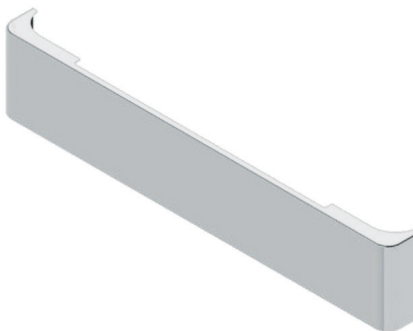

GO-0000-66 chrome
GO-0000-66S stainless

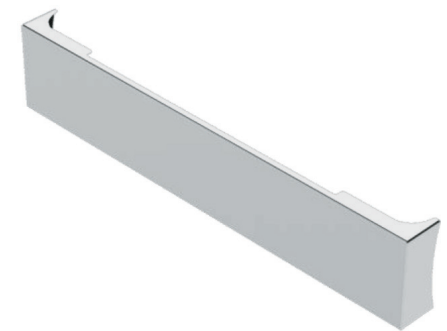

GO-0000-56 chrome
GO-0000-56S stainless

NOTE: DRILLING INTO A CHROME BUMPER IMMEDIATELY VOIDS ALL WARRANTIES.
WE RECOMMEND STAINLESS BUMPERS IF PLANNING TO DRILL INTO A BUMPER.

BLIND MOUNT BUMPERS

BLIND MOUNT BRACKETS:

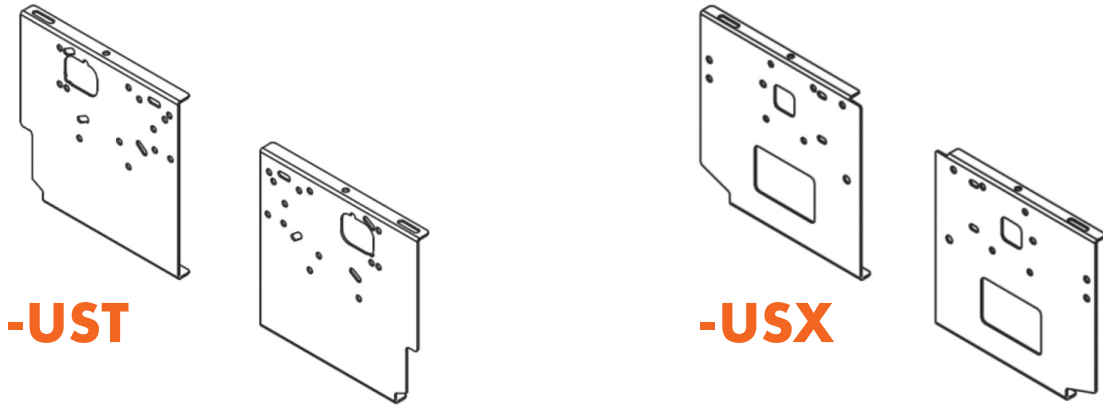

FITS THESE VALLEY CHROME MODEL CODES:
CB, CQ, FD, FE, HA, HC, GO

FITS THESE VALLEY CHROME MODEL CODES:
CU, CV, HC, HV, IC, GO



UST TOP FLANGE



USX TOP FLANGE

HOW TO CREATE A BLIND MOUNT BUMPER:

1. IDENTIFY YOUR MAKE & MODEL CODE FROM OUR CATALOG (EXAMPLE: PETE 389= 'HV')
2. CHOOSE YOUR CUTOUTS:
 - XXXX = no cutouts/no mounting bolts will show
 - 2XXX = rectangular fog light cutouts only
 - 2X1X = rectangular fog light and tow pin cutouts only
 - XX1X = tow pin cutouts only
 - XX10 = tag hanger bolt holes only ('HC' Peterbilt 379 only)
3. PICK YOUR END STYLE FROM PAGE 7
4. ADD ANY LIGHT OPTION CODES, IF DESIRED (SEE PAGES 89-90)
5. ADD LICENSE PLATE OPTION CODES, IF DESIRED (SEE PAGE 89)
6. APPLY 'UST' OR 'USX' SUFFIX ACCORDING TO BRACKETS SHOWN IN SECTION ABOVE

EXAMPLE: **HV-XXXX-682T-UST**

1 2 3 4

FROM THE ORIGINATORS OF THE BOLTLESS LOOK!



HV-XXXX-682T-UST
on a Pete 389

BUMPER MARKER LIGHT OPTIONS

SOME POPULAR OPTIONS SHOWN
MIX & MATCH YOUR OWN COMBINATIONS
SEE PAGE 106 FOR LED LIGHT OFFERINGS

GRANITE EXAMPLES:

KITS INCLUDE LIGHTS, BEZELS, WIRE HARNESS



-9GCA



-8GCA

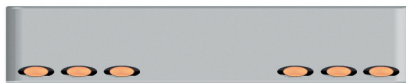

-6GCA

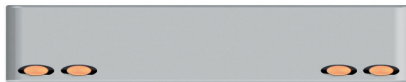

-4GCA



-9GA



-8GA



-6GA



-10GA
on boxed end bumper

GRANITE MINI EXAMPLES:

KITS INCLUDE LIGHTS, BEZELS, WIRE HARNESS



-25GMCA



-20GMCA



-8GMCA

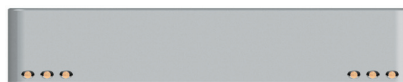

-6GMCA



-25GMA



-20GMA

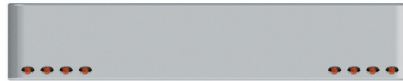

-8GMA

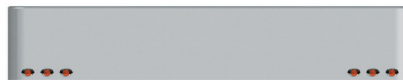

-6GMA

3/4" BULLSEYE EXAMPLES:

KITS INCLUDE LIGHTS, BEZELS, WIRE HARNESS



-74BYCA



-46BYCA



-20BYCA



-6BYCA



-74BYA



-25BYA



-15BYA



-2BYA

'FRENCHED' INSET LICENSE PLATE BOX:



-FL01



STANDARD LICENSE PLATE HOLES:



-L01



-L02

TOP TWO LICENSE PLATE HOLES:



-L2

PLACEMENT DEPENDS ON
BUMPER DESIGN

BUMPER MARKER LIGHT OPTIONS

SOME POPULAR OPTIONS SHOWN
MIX & MATCH YOUR OWN COMBINATIONS
SEE PAGES 106 FOR LED LIGHT OFFERINGS

OVAL LIGHT HOLE EXAMPLES:

LIGHT HOLE CUTOUTS ONLY

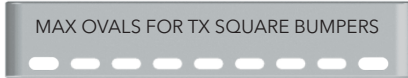

-009
(-011 MAX FOR BOXED END)



-008

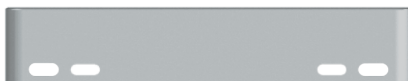

-004

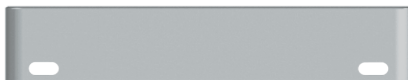

-002

SLOTTED RECESSED OVAL EXAMPLES:

LIGHT HOLE CUTOUTS ONLY

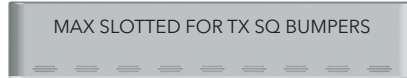

-BB9
-BB_ FOR SLOT HOLES ONLY, ADD YOUR OWN LIGHTS



-BB8

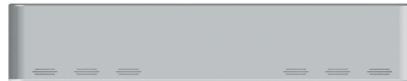

-BB6



-BB2

2" ROUND EXAMPLES:

LIGHT HOLE CUTOUTS ONLY



-R27



-R15

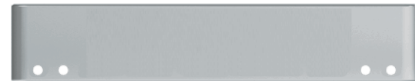

-R4



-R2

3/4" LIGHT HOLE EXAMPLES:

LIGHT HOLE CUTOUTS ONLY



-25BYN

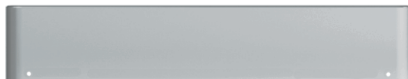

-2BYN

SLOTTED RECESSED OVAL EXAMPLES:

INCLUDES LIGHTS, 3M TAPE, WIRE HARNESS



-9SCA
CLEAR LENS/AMBER LEDs

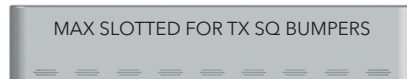

-9SA
AMBER LENS/AMBER LEDs

4" ROUND EXAMPLES:

LIGHT HOLE CUTOUTS ONLY



-R13C

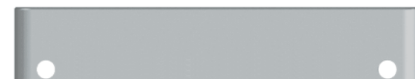

-R2C

WATERMELON EXAMPLES:

LIGHT HOLE CUTOUTS ONLY

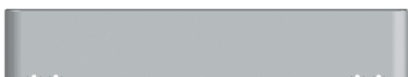

-W4

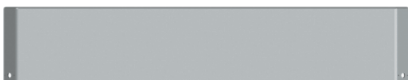

-B1W

WATERMELON HOLES ON ANGLED ENDS
45° MITRED END ROADRUNNER BUMPER

BOXED END EXAMPLES:

LIGHT HOLE CUTOUTS ONLY

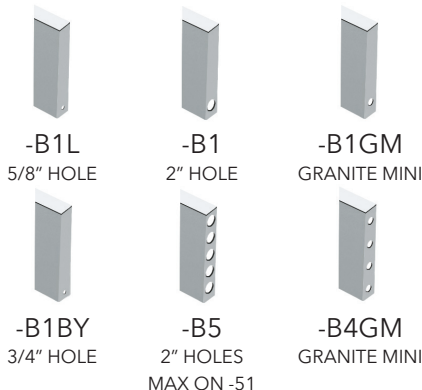

-B1L
5/8" HOLE

-B1
2" HOLE

-B1GM
GRANITE MINI

-B1BY
3/4" HOLE

-B5
2" HOLES
MAX ON -51

-B4GM
GRANITE MINI

COMBO PATTERN EXAMPLES:

LIGHT HOLE CUTOUTS ONLY



-A06-R8



-R2C-004

COMBO LIGHT NUMBERING
PATTERN GOES FROM OUTSIDE OF
BUMPER TO CENTER

BUMPER LASER-CUT TEXT OPTIONS



TEXT 1



TEXT 8



TEXT 2



TEXT 9



TEXT 3



TEXT 10



TEXT 4



TEXT 11



TEXT 5



TEXT 12



TEXT 6



TEXT 13



TEXT 7

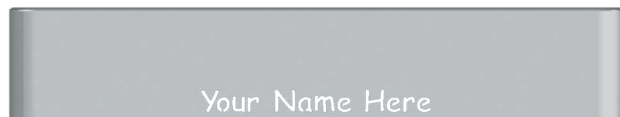

TEXT 14

LIGHT BOXES TO MOUNT BEHIND YOUR GRAPHIC



LX-24 MOUNTED BEHIND DUPONT LOGO
- ACTUAL NASCAR HAULER -

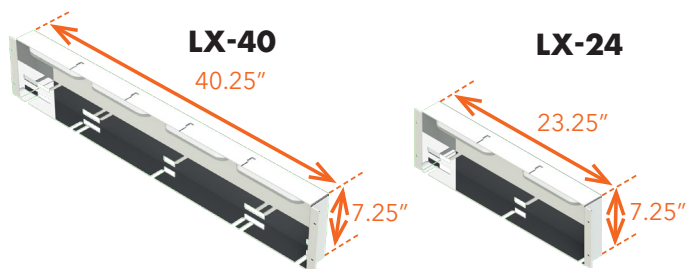

BUMPER MOUNTING BOLT KITS

'UNIVERSAL' HEX BOLT SERIES

PACKAGED FOR RETAIL

POLISHED STAINLESS STEEL BOLTS

SIZE: #12 - 1.75 x 50 PARTIAL THREAD

ZINC PLATED WASHERS AND LOCKNUTS

WHITE NYLON WASHERS PROTECT CHROME SURFACE AFTER INSTALLATION



VU190082 SHOWN PACKAGED

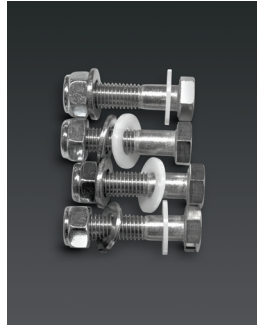

VU190080
4 PCS KIT

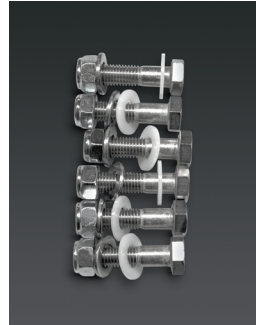

VU190081
6 PCS KIT



VU190082
8 PCS KIT



VU190085
NYLON WASHERS 25-PACK

PACCAR SERIES

PACKAGED FOR RETAIL

FITS PETERBILT 389 & KENWORTH W990 & SIMILAR CHASSIS

ZINC PLATED WASHERS AND LOCKNUTS

WHITE NYLON WASHERS PROTECT CHROME



VP190083



UNIVERSAL ACCESSORIES SECTION

LED LIGHTING AND STAINLESS PARTS
TO FIT MOST TRUCK MAKES



STAINLESS ACCESSORIES

UNIVERSAL

FLAP WEIGHTS

WEIGHTS INCLUDE MOUNTING HARDWARE
EACH SOLD AS A PAIR



VU190000
UNIVERSAL FLAP WEIGHT
- 24" - BOTTOM - ANY MAKE
- 11GA. STAINLESS - GIRLS



VU190001
UNIVERSAL FLAP WEIGHT
- 24" - BOTTOM - ANY MAKE
- 11GA. STAINLESS



VU190002
UNIVERSAL FLAP WEIGHT
- 24" TOP - ANY MAKE
- 11GA. STAINLESS



VU190003
UNIVERSAL FLAP WEIGHT
- 24" - U SHAPED BOTTOM
- 11GA. STAINLESS



VU190102
UNIVERSAL FLAP WEIGHT
- 24" - BOTTOM - ANY MAKE
- 11GA. STAINLESS - STEER HEAD



VU190109
UNIVERSAL FLAP WEIGHT
- 24" - U SHAPED BOTTOM
- 11GA. STAINLESS - STEER HEAD

TANK STRAPS



VU190005
9.75" AIR TANK BANDS
(PB. KW. FL) - PAIR

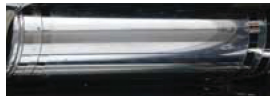

VU190061
AIR TANK WRAP - FITS 9.75"
STAINLESS AIR TANK - 1 PC
COVER ONLY



VU190006
8.25" AIR TANK BANDS
(PB. KW. FL) - PAIR

TAG HANGERS

EACH INCLUDE MOUNTING HARDWARE,
FOAM PROTECTORS & TAG MOUNTING PLASTIC INSERTS

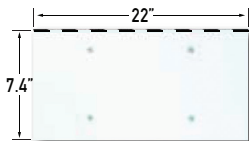

VP120000
HINGED 1 TAG HANGER
18 GA. STAINLESS
PETE 389

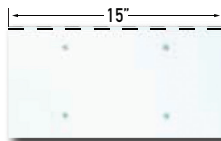

VP120001
HINGED 1 TAG HANGER
18 GA. STAINLESS
PETE 379 & SIMILAR

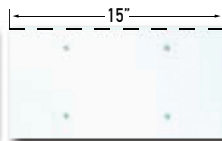

VP120017
HINGED 1 TAG HANGER
24 GA. STAINLESS
PETE 379 & SIMILAR

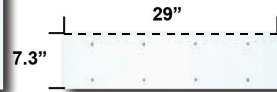

VU190007
HINGED 2 TAG HANGER (PB. KW. FL)

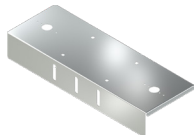

VU190035-2W
SINGLE TAG HANGER
W/2 WATERMELON CUTOUTS



VU190035
TAG HANGER - SINGLE
TAG - 90 DEGREE
MOUNTS UNDER



VU190036
TAG HANGER - SINGLE
2 TAG - 90 DEGREE
MOUNTS UNDER



VU190037
TAG HANGER - SINGLE
3 TAG - 90 DEGREE
MOUNTS UNDER



VU190008
HINGED 3 TAG HANGER (PB. KW. FL)

TAG HANGERS WITH WATERMELONS INSTALLED



VU120001-2WA
SINGLE TAG HANGER
W/2 AMBER WATERMELONS



VU190007-2WA
DUAL TAG HANGER
W/2 AMBER WATERMELONS



VU190008-2WA
TRIPLE TAG HANGER
W/2 AMBER WATERMELONS

STAINLESS ACCESSORIES

UNIVERSAL

PERMIT PANELS

HINGED PANELS INCLUDES MOUNTING HARDWARE



VU190090
HINGED PERMIT PANEL
4 X 4



VU190091
HINGED PERMIT PANEL
4 X 8



VU190092
HINGED PERMIT PANEL
4 X 10



VU190093
HINGED PERMIT PANEL
4 X 12



VU190094
HINGED PERMIT PANEL
5 X 4



VU190095
HINGED PERMIT PANEL
5 X 8



VU190096
HINGED PERMIT PANEL
5 X 10



VU190097
HINGED PERMIT PANEL
5 X 12

FLAT PANELS INCLUDE STRONG 3M DOUBLE SIDED TAPE



VU190098
FLAT PERMIT PANEL
4 X 4 - TAPE MOUNT



VU190099
FLAT PERMIT PANEL
4 X 8 - TAPE MOUNT



VU190103
FLAT PERMIT PANEL
4 X 10 - TAPE MOUNT



VU190104
FLAT PERMIT PANEL
4 X 12 - TAPE MOUNT



VU190105
FLAT PERMIT PANEL
5 X 4 - TAPE MOUNT

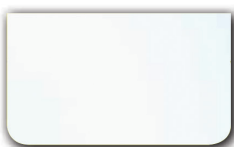

VU190106
FLAT PERMIT PANEL
5 X 8 - TAPE MOUNT

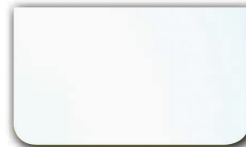

VU190107
FLAT PERMIT PANEL
5 X 10 - TAPE MOUNT

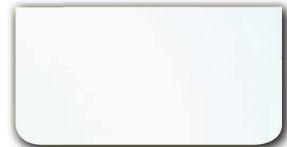

VU190108
FLAT PERMIT PANEL
5 X 12 - TAPE MOUNT

STAINLESS ACCESSORIES

UNIVERSAL

RIDGED PERMIT PANELS

90-DEGREE BEND AT TOP, NO-HINGE
INCLUDES MOUNTING HARDWARE
CUSTOMER DRILLS TO FIT



VU190110
RIDGED PERMIT PANEL
4 X 4



VU190111
RIDGED PERMIT PANEL
4 X 8



VU190112
RIDGED PERMIT PANEL
4 X 10



VU190113
RIDGED PERMIT PANEL
4 X 12



VU190114
RIDGED PERMIT PANEL
5 X 4

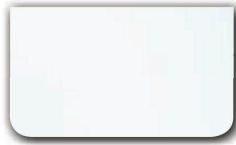

VU190115
RIDGED PERMIT PANEL
5 X 8

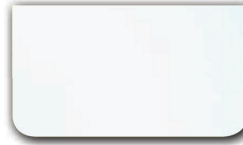

VU190116
RIDGED PERMIT PANEL
5 X 10



VU190117
RIDGED PERMIT PANEL
5 X 12

BEACON LIGHT BRACKETS

INCLUDES MOUNTING HARDWARE



VU190100
BEACON LIGHT BRACKET
8" X 8" - PR

STAINLESS ACCESSORIES

UNIVERSAL AIRLINE BOXES

MOUNTING HARDWARE INCLUDED
AIR LINE BOXES ARE 32" LONG - CLOSED
BACK
NOT AVAILABLE IN 430 STAINLESS



VU190015
AIR LINE BOX - STANDARD

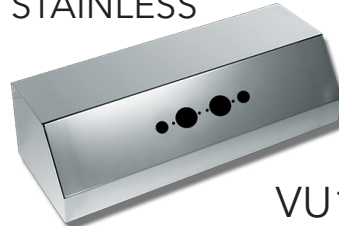

VU190016R
AIR LINE BOX - 2-PLUG

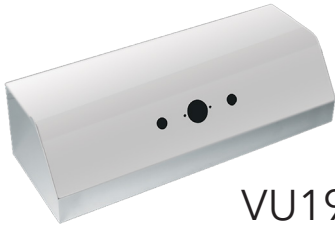

VU190015R
AIR LINE BOX - STANDARD - ROUNDED

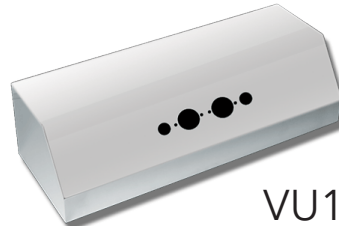

VU190016R
AIR LINE BOX - 2-PLUG - ROUNDED

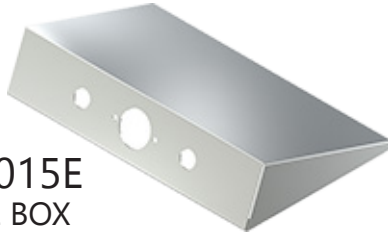

VU190015E
AIR LINE BOX



VU190015D
AIR LINE BOX - RECESSED

TO BUILD A LIGHT BOX

1. PICK BLANK PART NUMBER
2. PICK LIGHT TYPE (REFER TO PAGE 106-107)
3. PICK THE NUMBER OF LIGHTS

EXAMPLE: VU190016R-2CA

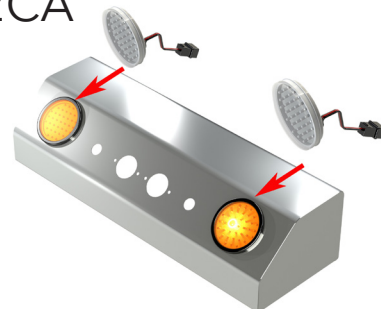
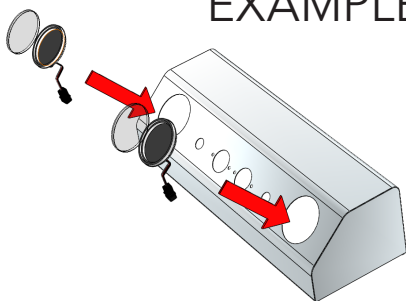

STAINLESS ACCESSORIES

UNIVERSAL DECK PLATES



VU190017
DECK PLATE - 36" X 34" -
SMOOTH
STAINLESS - OVER FRAME RAILS



VU190018
DECK PLATE - 48" X 34" -
SMOOTH
STAINLESS - OVER FRAME RAILS

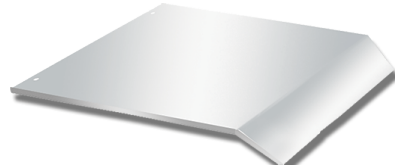

VU190017
REAR DECK PLATE - 29" X 34" -
SMOOTH
ROLLED EDGES - OVER FRAME RAILS



VU192010
FRONT DECK PLATE - 83" X 27"
11G, SS - BETWEEN FRAME RAILS



VU192011
MID DECK PLATE - 44" X 27"
11G, SS - BETWEEN FRAME RAILS



VU192012
REAR DECK PLATE - 48" X 27"
11G, SS - BETWEEN FRAME RAILS



VU192022
MID DECK PLATE - 77" X 27"
11G, SS - BETWEEN FRAME RAILS

FRONT DECK PLATE TOOL BOX

VU192021
UNIVERSAL FRONT DECK PLATE TOOL BOX
W/LOCK - 24" X 24"

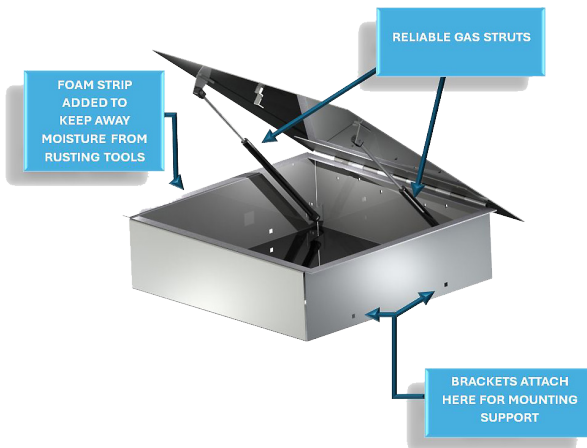

STAINLESS ACCESSORIES

UNIVERSAL

REAR FRAME TOOL BOX



VP150119

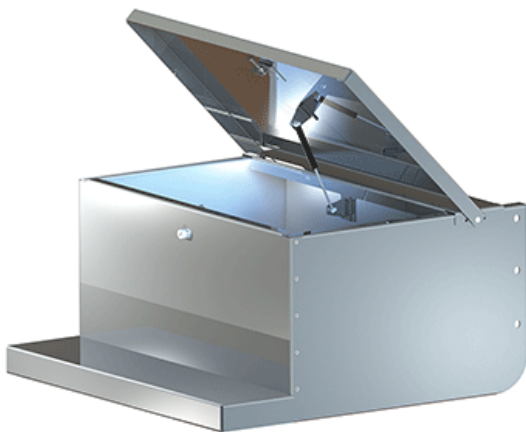

- Highly polished 304 non-directional stainless steel
- All makes fit, anywhere frame space and ground clearance is available
- Lock and keys included
- Direct raised lid with gas shock
- Brackets and hardware not included, fit to your custom location



STAINLESS ACCESSORIES

UNIVERSAL FRAME STEPS

INCLUDES SLIP RESISTANT GRIP TAPE



VU191103
FRAME STEPS - 12"
STAINLESS STEPS & SIDES

VU191104
FRAME STEPS - 18"
STAINLESS STEPS & SIDES

VU191105
FRAME STEPS - 24"
STAINLESS STEPS & SIDES



VU191106
FRAME STEPS - 12"
ALUMINUM STEPS & SIDES

VU191107
FRAME STEPS - 18"
ALUMINUM STEPS & SIDES

VU191108
FRAME STEPS - 24"
ALUMINUM STEPS & SIDES



STAINLESS ACCESSORIES

UNIVERSAL REAR WINDOW VISORS NOT AVAILABLE ON DAYCAB

INCLUDES STRONG 3M DOUBLE-SIDED TAPE AND MOUNTING HARDWARE

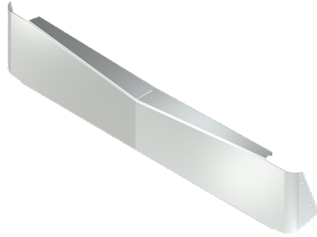

VU193020-BT
REAR VISOR GANGSTER-
BOWTIE

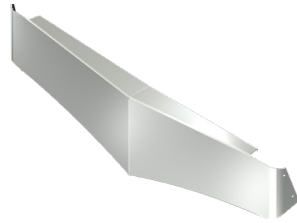

VU195020
REAR VISOR WICKED -
ONE-PIECE



VU193020
REAR VISOR GANGSTER

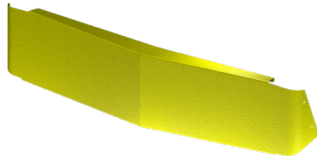

EXAMPLE
VU193020P
REAR VISOR GANGSTER

**PAINTABLE
VISORS
AVAILABLE**

JUST ADD "P" TO THE END
FOR PAINTABLE
RAW18 GAUGE STEEL
COLORS SHOWN EXAMPLES ONLY

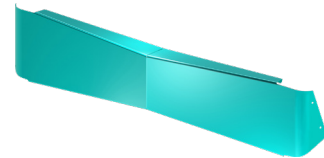

EXAMPLE
VU193020P-BT
REAR VISOR - GANGSTER
BOWTIE

REAR FRAME FILLERS

BOXES COME WITH VU190201 BACK COVER
18-GAUGE STAINLESS STEEL MOUNTING HARDWARE INCLUDED



VU190203
REAR FRAME FILLER
2, 4" RND LEDS & 3, GRANITE
RED LEDS



VU190202
REAR FRAME FILLER
4, 4" RND LEDS



VU190203
REAR FRAME FILLER
4, 4" RND LEDS & 5, 2"
RND



VU190204
REAR FRAME FILLER
12, 2" RND LEDS



VU190201
REAR FRAME FILLER
BACK COVER

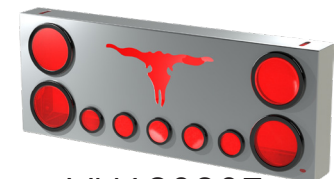

VU190207
REAR FRAME FILLER
4, 4" RND LEDS & 5, 2"
LEDS, W/STEERHEAD

BLANK BOXES AVAILABLE
(VU19200)

STAINLESS ACCESSORIES

UNIVERSAL

REAR FRAME FILLERS

NOT AVAILABLE ON DAYCAB

INCLUDES STRONG 3M DOUBLE-SIDED TAPE AND MOUNTING HARDWARE



VU190208
REAR FRAME FILLER - 2 - 4"
RD / 3 - GRANITE- LEDS -
W / STEERHEAD



VU190209
REAR FRAME FILLER - 4 - 4"
RD - LEDS - CLEAR LENS /
EACH CORNER



VU190210
REAR FRAME FILLER - 4 - 4"
RD / 5 - 2" RD - LEDS -
CLEAR LENS

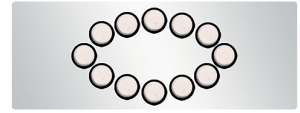

VU190211
REAR FRAME FILLER - 12 - 2"
RD - LEDS - CLEAR LENS /
OVAL



VU190212
REAR FRAME FILLER - 2 - 4"
RD / 8 - 2" RD - LEDS -
CLEAR LENS



VU190213
REAR FRAME FILLER - 2 - 4"
RD / 3 - GRANITE - LEDS -
CLEAR LENS



VU190214
REAR FRAME FILLER - 4 - 4"
RD / 5 - 2" RD - LEDS - CLEAR
LENS - W / STEERHEAD

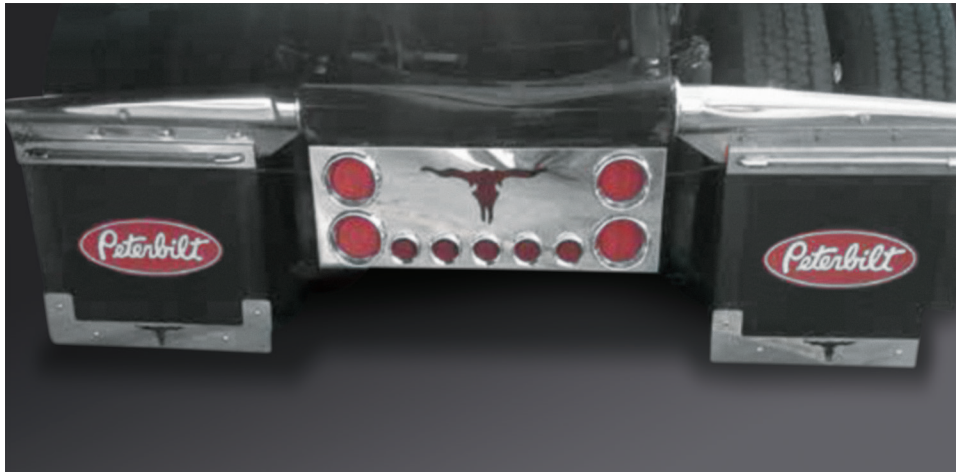

VU190214-4CR-5RR
(chrome light bezels not included)

Mud flap weights VU190109 also shown

STAINLESS ACCESSORIES

UNIVERSAL

LOWER REAR FRAME FILLERS



VU199002
LOWER REAR FRAME FILLER
- BLANK



VU199005
LOWER REAR FRAME FILLER -
379 - BLANK

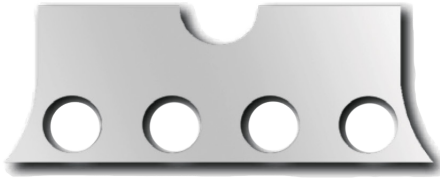

VU199002-4CN
LOWER REAR FRAME FILLER -
4 ROUND CUTOUTS

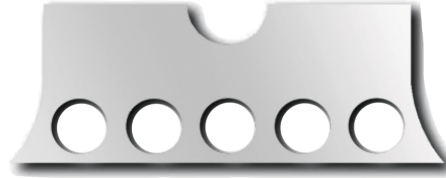

VU199002-5CN
LOWER REAR FRAME FILLER -
5 ROUND CUTOUTS



VU199002-5CR shown, includes lights and harness
CHROME LIGHT BEZELS NOT INCLUDED
WILL NOT WORK ON ALUMINUM FRAMES

STAINLESS ACCESSORIES

UNIVERSAL

RETAIL DISPLAY - LEDS

For authorized distributors



2 PACKAGES AVAILABLE:

PART# VULIGHTKIT3 FOR 12 OF EACH LIGHT AND DISPLAY BOARD

PART# VULIGHTKIT4 FOR 24 OF EACH LIGHT AND DISPLAY BOARD

Actual light display board may vary from illustration above.



STAINLESS ACCESSORIES

UNIVERSAL

LED LIGHT OPTION CHART

Use the following light chart to build your rear light bars, cab and sleeper panels, hood extension panels, and so on. Use the first letter in the name of the light and the form you wish the light to be.

Solid Accessory Part Number	Dash	Amount of Lights	Lights name - 1st letter	Lights Color	=	Complete Part Number with Lights
Vxxxxxxx	-	X	X	X	=	Vxxxxxxx-XXX
VP142007	-	7	G	CA	=	VP142007-7GCA

EXAMPLE:



VP142007-7GCA

Peterbilt 379 cab panel VP142007, with seven Granite clear lens amber LED light assemblies & wire harness

LIGHT OFFERINGS WITH LETTER AND LIGHT COLOR CODES:



OVAL 6"

Amber lens, Amber LEDs = O A
 Clear lens, Amber LEDs = O CA
 Red lens, Red LEDs = O R
 Clear lens, Red LEDs = O CR



GRANITE

Amber lens, Amber LEDs = G A
 Clear lens, Amber LEDs = G CA
 Red lens, Red LEDs = G R
 Clear lens, Red LEDs = G CR



GRANITE MINI

Amber lens, Amber LEDs = GM A
 Clear lens, Amber LEDs = GM CA
 Red lens, Red LEDs = GM R
 Clear lens, Red LEDs = GM CR



ROUND 2"

Amber lens, Amber LEDs = R A
 Clear lens, Amber LEDs = R CA
 Red lens, Red LEDs = R R
 Clear lens, Red LEDs = R CR

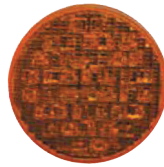

CORAL 4" ROUND

Amber lens, Amber LEDs = C A
 Clear lens, Amber LEDs = C CA
 Red lens, Red LEDs = C R
 Clear lens, Red LEDs = C CR



BULLSEYE ¾" ROUND

Amber lens, Amber LEDs = BY A
 Clear lens, Amber LEDs = BY CA
 Red lens, Red LEDs = BY R
 Clear lens, Red LEDs = BY CR

STAINLESS ACCESSORIES

UNIVERSAL

BLANK LIGHT CUTOUT OPTIONS

Add your own lights to our accessories, but first get the correct cutouts:

Solid Accessory Part Number	Dash	Amount of Lights	Lights name - 1st letter	Lights Color	=	Complete Part Number with Lights
Vxxxxxxx	-	X	X	X	=	Vxxxxxxx-XXX
VP142007	-	10	BY	N	=	VP142007-10BYN

EXAMPLE:



VP142007-10BYN

Peterbilt 379 cab panel VP142007, with ten open 3/4" light holes

CUTOUT CODES:

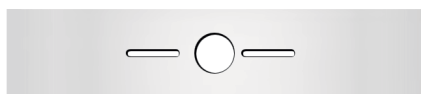

UNIVERSAL/COMBO
Fits a variety of lights on the market.
See cutout dimensions shown to the right.

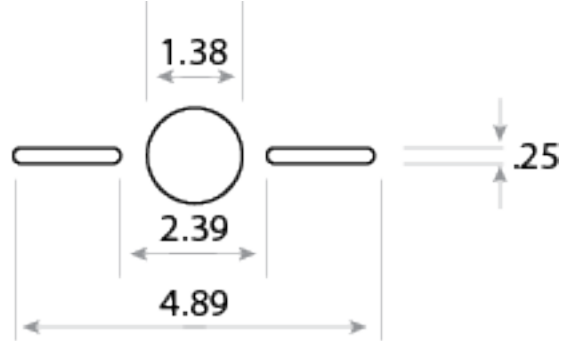

SN

OVAL SLOTTED

Mount your 6" oval light with double-sided tape behind the cutout



RN

2" ROUND



BYN

3/4" ROUND

"N" LIGHT COLOR INDICATES NO LIGHTS/OPEN CUTOUT

STAINLESS ACCESSORIES

**3-YEAR
WARRANTY**

VU-860L
2" Round



VU-860L-A shown

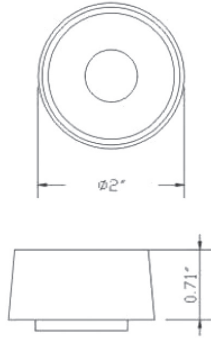

UNIVERSAL LED LIGHTS

- 9 LEDs
- 12 volt
- Sonically sealed polycarbonate lens & housing
- Epoxy encapsulated electronics and sealed wire entry prevent dirt and moisture from entering the light
- Includes a rubber grommet when ordered as a kit with bumper or accessory
- IP67 Rated

Part Numbers	Lens Color	LED Color
VU-860L-A	Amber	Amber
VU-860L-CA	Clear	Amber
VU-860L-R	Red	Red
VU-860L-CR	Clear	Red

**3-YEAR
WARRANTY**

VU-924-1L
4" ROUND
"CORAL"

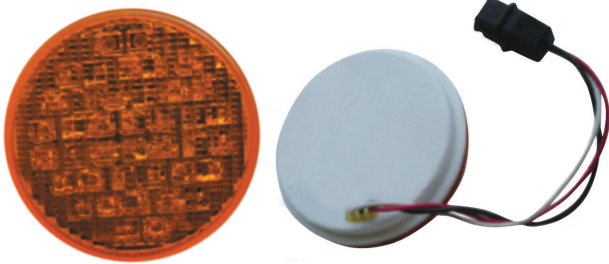

VU-924-1L-A shown

- 40 LEDs
- 12 volt or 24 volt
- Chrome reflector for brilliant light emission
- Sonically sealed polycarbonate lens & housing
- Epoxy encapsulated electronics and sealed wire entry prevent dirt and moisture from entering the light
- Includes a rubber grommet when ordered as a kit with bumper or accessory
- IP67 Rated

Part Numbers	Lens Color	LED Color
VU-924-1L-A	Amber	Amber
VU-924-1L-CA	Clear	Amber
VU-924-1L-R	Red	Red
VU-924-1L-CR	Clear	Red
VU-924-1L-CW	Clear	White

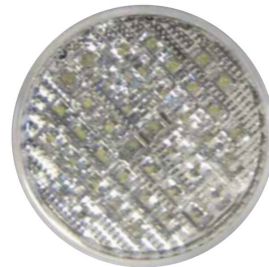
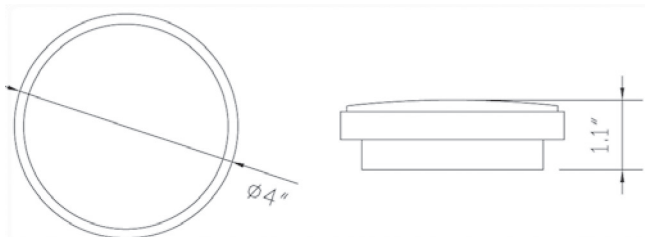

VU-924-1L-CW shown

STAINLESS ACCESSORIES

UNIVERSAL

SIGNATURE MARKER LIGHTS

**3-YEAR
WARRANTY**



VU-1080L-A shown

VU-1080L
GRANITE



Part Numbers	Lens Color	LED Color
VU-1080L-A	Amber	Amber
VU-1080L-CA	Clear	Amber
VU-1080L-R	Red	Red
VU-1080L-CR	Clear	Red

- 6 LEDs
- 12 volt
- Sonically sealed polycarbonate lens & housing
- Epoxy encapsulated electronics and sealed wire entry prevent dirt and moisture from entering the light
- Includes chrome bezel
- IP67 Rated



VU-7160L-A shown

VU-7160L
GRANITE MINI

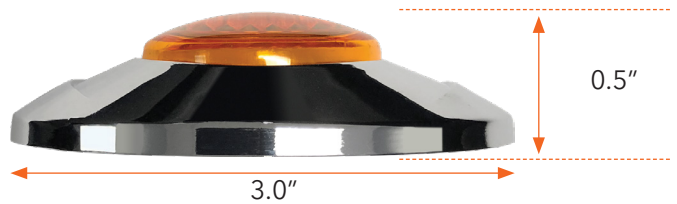

Part Numbers	Lens Color	LED Color
VU-7160L-A	Amber	Amber
VU--7160L-CA	Clear	Amber
VU--7160L-R	Red	Red
VU--7160L-CR	Clear	Red

- 3 LEDs
- 12 volt
- Sonically sealed polycarbonate lens & housing
- Epoxy encapsulated electronics and sealed wire entry prevent dirt and moisture from entering the light
- Includes chrome bezel
- IP67 Rated

**3-YEAR
WARRANTY**

STAINLESS ACCESSORIES

UNIVERSAL

SIGNATURE MARKER LIGHTS

**3-YEAR
WARRANTY**



VU-1094L
GRANITE SLIM



- 3 LEDs
- 12 volt
- Sonically sealed polycarbonate lens & housing
- Epoxy encapsulated electronics and sealed wire entry prevent dirt and moisture from entering the light
- Includes chrome bezel
- IP67 rated

Part Numbers	Lens Color	LED Color
VU-1094L-A	Amber	Amber
VU-1094L-CA	Clear	Amber
VU-1094L-R	Red	Red
VU-1094L-CR	Clear	Red

GRANITE COLLECTION COUNTERTOP DISPLAYS AVAILABLE

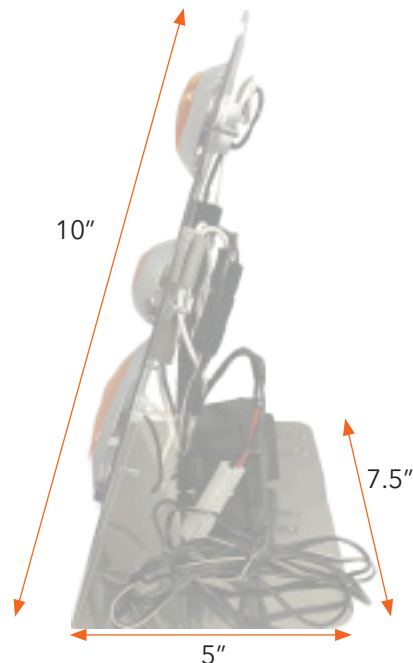

VU-LDG3-BK FOR BLACK POWDER COATED DISPLAY
VU-LDG3-SS FOR POLISHED STAINLESS STEEL DISPLAY

STAINLESS ACCESSORIES

**3-YEAR
WARRANTY**

UNIVERSAL

LED LIGHTS

VU-998-1L

$\frac{3}{4}$ " ROUND
"BULLSEYE"

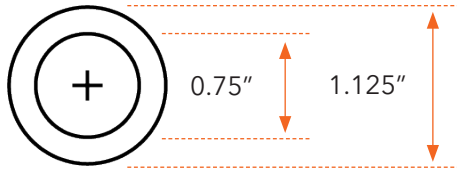

VU-998-1L-CA shown

- 3 LEDs
- 12 volt
- Sonically sealed polycarbonate lens & housing
- Epoxy encapsulated electronics and sealed wire entry prevent dirt and moisture from entering the light
- Includes chrome bezel
- IP67 Rated

Part Numbers	Lens Color	LED Color
VU-998-1L-A	Amber	Amber
VU-998-1L-CA	Clear	Amber
VU-998-1L-R	Red	Red
VU-998-1L-CR	Clear	Red

**3-YEAR
WARRANTY**

VU-968-1L

6" OVAL



VU-968-1L-R shown

(rear view)



- 21 Super LEDs
- 12 volt
- Chrome reflector for brilliant light emission
- Sonically sealed polycarbonate lens & housing
- Epoxy encapsulated electronics and sealed wire entry prevent dirt and moisture from entering the light
- Includes an ABS plastic snap-ring and rubber grommet when ordered as a kit with bumper or accessory
- IP67 Rated

Part Numbers	Lens Color	LED Color
VU-968-1L-A	Amber	Amber
VU-968-1L-CA	Clear	Amber
VU-968-1L-R	Red	Red
VU-968-1L-CR	Clear	Red
VU-968-1L-CW	Clear	White



VU-968-1L-A shown
with ABS snap ring



VU-968-1L-CW shown

Dimensions with grommet:



STAINLESS ACCESSORIES

UNIVERSAL

LED LIGHTS

**3-YEAR
WARRANTY**

VU-949-1L

"TORPEDO" CAB MARKER

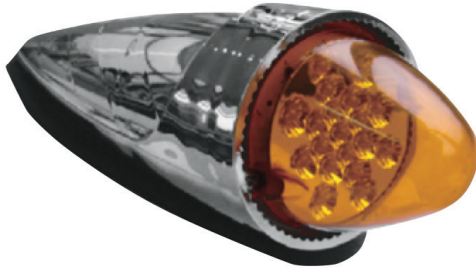

VU-949-1L-A shown

- 19 LEDs
- 12 volt
- Chrome reflector for brilliant light emission
- Bright chrome outer housing
- Rubber mounting pad
- Sonically sealed polycarbonate lens & housing
- Epoxy encapsulated electronics and sealed wire entry prevent dirt and moisture from entering the light
- Includes chrome bezel
- IP67 Rated

Part Numbers	Lens Color	LED Color
VU-949-1L-A	Amber	Amber
VU-949-1L-CA	Clear	Amber

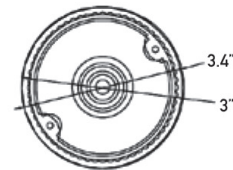
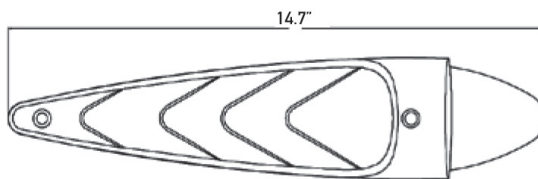

VU-855L

VINTAGE CAB MARKER



VU-855L-A shown

- 36 LEDs
- 12 volt
- Bright chrome outer housing
- Sonically sealed polycarbonate lens & housing
- Epoxy encapsulated electronics and sealed wire entry prevent dirt and moisture from entering the light
- Includes chrome bezel
- IP67 Rated

**3-YEAR
WARRANTY**

Part Numbers	Lens Color	LED Color
VU-855L-A	Amber	Amber
VU-855L-CA	Clear	Amber

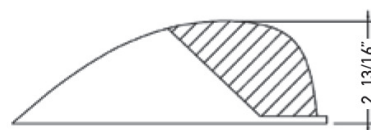
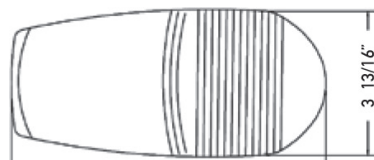

STAINLESS ACCESSORIES

UNIVERSAL

**3-YEAR
WARRANTY**

PETE TURN/PARK/CLEARANCE LIGHT

VU-951L

6" x 5" CLEARANCE

- 31 Super LEDs
- IP67 Rated
- 12 volt
- Sonically sealed polycarbonate lens & housing
- Epoxy encapsulated electronics and sealed wire entry prevent dirt and moisture from entering the light

Part Numbers	Lens Color	LED Color
VU-951L-A	Amber	Amber
VU-951L-CA	Clear	Amber



VU-951L-A shown

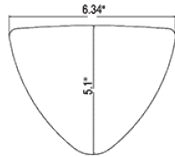
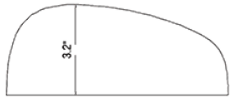

WATERMELON LIGHTS



Amber (VU-1110L-A)



Blue (VU-1110L-B)



Purple (VU-1110L-P)



Red (VU-1110L-R)



Clear (VU-1110L-C)



Green (VU-1110L-G)

STAINLESS ACCESSORIES

UNIVERSAL WATERMELON LIGHT BRACKETS

1-YEAR
WARRANTY

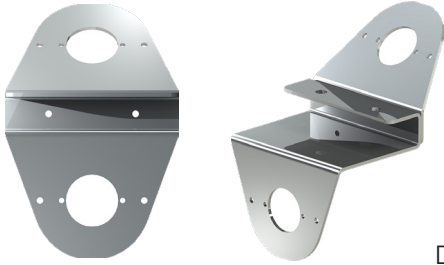

VU190123

DUAL WATERMELON FRAME BRACKET
CUTOUTS ONLY



VK170101

DUAL WATERMELON INTERIOR BRACKET
W/SWITCH HOLE (CUTOUTS ONLY)

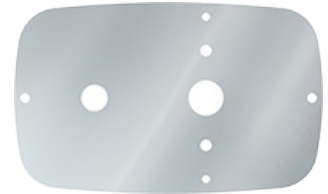

VP170109

SINGLE WATERMELON INTERIOR BRACKET
W/SWITCH HOLE (CUTOUTS ONLY)



VU190120

SINGLE WATERMELON MIRROR BRACKET
CUTOUTS ONLY



VWM011

SINGLE WATERMELON INTERIOR BRACKET
W/SWITCH HOLE (CUTOUTS ONLY)



VK170100

SINGLE WATERMELON INTERIOR BRACKET
W/SWITCH HOLE (CUTOUTS ONLY)



VU190132

SINGLE WATERMELON FRAME BRACKET
CUTOUTS ONLY



VU110100

SINGLE WATERMELON BUMPER
TIRE GUARD BRACKET
UNIVERSAL

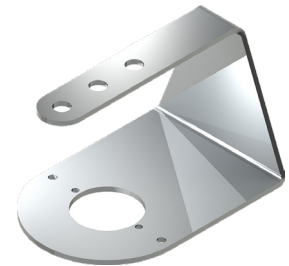

VU190129

SINGLE WATERMELON MIRROR BRACKET
UNIVERSAL



VU190121

UNIVERSAL UNDER-FRAME MOUNT
SINGLE WATERMELON LIGHT BRACKET



VU190128

SINGLE WATERMELON FRAME BRACKET
CUTOUTS ONLY



VU190130

DUAL WATERMELON FRAME BRACKET
CUTOUTS ONLY

STAINLESS ACCESSORIES

UNIVERSAL WATERMELON LIGHT BRACKETS CONT'D

**1-YEAR
WARRANTY**



VU190127

SINGLE WATERMELON ANGLED FRAME BRACKET
CUTOUTS ONLY

UNIVERSAL WIRE HARNESSSES

VU-877F

FEMALE HARNESS

- 2 female bullets
- 100 ft. length
- Available in 4", 6", 8" or 10" spacing - see part numbers

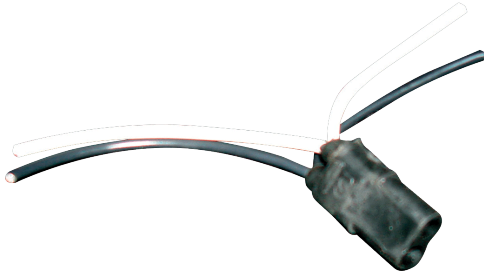

VHMS3007

AIR CLEANER LIGHT BOX HARNESS

- See pages 126, 134, 166 for air cleaner light boxes
- One PACCAR female end
- Two PACCAR male ends



Part Numbers	Bullet spacing
VU-877F-4	4"
VU-877F-6	6"
VU-877F-8	8"
VU-877F-10	10"

**VE VALLEY
CHROME
PLATING**

STAINLESS ACCESSORIES

**MACK
ANTHEM**



STAINLESS ACCESSORIES

VISORS

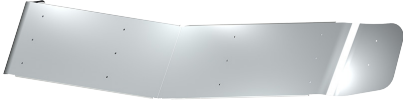

VM130001-12

ANTHEM 12" FACTORY REPLACEMENT
VISOR

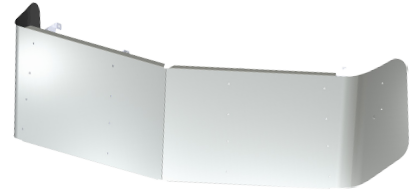

VM130001

ANTHEM 17" FACTORY REPLACEMENT
VISOR

CAB & SLEEPER PANELS

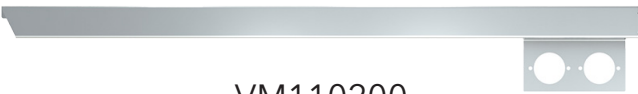

VM110200

ANTHEM CAB PANEL WITH FAIRINGS
WITH DUAL HEATER PLUGS

STAINLESS ACCESSORIES

PETERBILT MODEL 359



Bumpers and Stainless Accessories made in the USA



www.valleychrome.com

STAINLESS ACCESSORIES

PETERBILT MODEL 359

CAB PANEL 3.5"

MOUNTING HARDWARE INCLUDED



VP110235
PB CAB PANELS - 359 -
STANDARD BLANK - PAIR



VP110238
PB CAB PANEL, EXT. PANEL
FORMED 359 2PC. STANDARD
WRAP BLANK - PAIR



VP110236
PB CAB PANELS - 359 -
STANDARD WRAP BLANK - PAIR



VP110236 shown

ADD LIGHTS TO YOUR PANEL - SEE PAGES 106-107

HOOD EXTENSIONS



VP110319
PB - 359 HOOD EXTENSION
PANEL - FACTORY



STAINLESS ACCESSORIES

PETERBILT MODEL 359

MISC. TRIM PIECES



VP110023

PB 359 TOP OF DOOR TRIM - LOWERED LOOK - 359

CUSTOM HEIGHTS AVAILABLE



VP110023-P FOR PAINTABLE



VP110027

PB 359 WINDSHIELD WIPER ARM COVERS



VP120113

PB BUG SHIELD - STAINLESS
- 359

MOUNTING HARDWARE INCLUDED



VP120504

PB 359 FENDER SUPPORT
COVER - FRONT - BLANK

RUBBER TRIM AND MOUNTING
HARDWARE INCLUDED



STAINLESS ACCESSORIES

PETERBILT MODEL 359

STANDARD MOUNT STAINLESS VISORS



VP130001

PB - 359 12" DROP VISOR - ANY YEAR 359

**PAINTABLE
VISORS
AVAILABLE**

JUST ADD "P" TO THE END
FOR PAINTABLE. EXAMPLE:

VP130001-P

RAW 18 GAUGE STEEL

ADD LIGHTS TO YOUR VISOR - SEE PAGES 106-107

FOR MORE PETE VISORS SEE PAGES 198-201

GANGSTER STAINLESS VISORS



VP132001

PB - 12" GANGSTER VISOR - 359 2 PC



VP132001-BT

PB - 12" GANGSTER BOWTIE VISOR - 359 2 PC



VP132001-BF

PB - 12" GANGSTER BUTTERFLY VISOR - 359 2 PC



VP132001-RBF

PB - 12" GANGSTER VISOR - 359 2 PC, REVERSE BUTTERFLY

VP132001P-RBF

PB - 12" GANGSTER VISOR - 359 - PAINTABLE 2 PC, REVERSE BUTTERFLY



VP132001G-RBF

PB - 12" GANGSTER VISOR - 359 - 1 PC, REVERSE BUTTERFLY

WICKED VISORS



VP135001

PB - 12" WICKED - DROP VISOR -
ANY YEAR 359 - 2 PC

STAINLESS ACCESSORIES

PETERBILT MODEL 359 AIR DEFLECTORS



VP110016
PB 359 - 379, 389 WINDOW
AIR DEFLECTORS



VP110031
PB 359 - 379, 389 WINDOW
AIR DEFLECTORS W/LOWER
LOOKS(VP110017)WINDOW
TRIM 37.25" X 20.375"

FUEL TANK STRAP COVERS BRACKETS & MOUNTING HARDWARE INCLUDED



VP150039
PB 359 - FUEL TANK STRAP
COVERS - 2PCS



MISC. TRIM PIECES

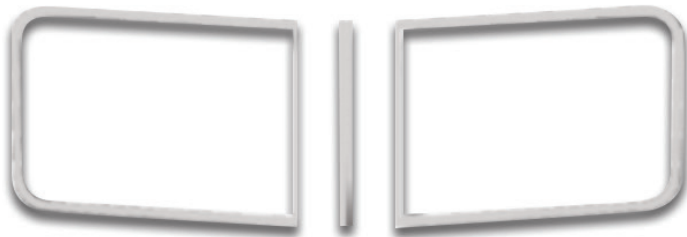

VP110024
PB WINDSHIELD TRIM - 3 PC 359 -
STANDARD - 430 STAINLESS



VP110012
359, 379 DOOR FLAME
TRIM - PAIR

STAINLESS ACCESSORIES

PETERBILT MODELS 365 & 367



Bumpers and Stainless Accessories made in the USA



www.valleychrome.com

STAINLESS ACCESSORIES

PETERBILT MODEL 365 & 367

CAB PANELS 4"

MOUNTING HARDWARE INCLUDED



VP110241

PB CAB PANELS - 2005 &
NEWER - 367, 365 - BLANK
WRAP - SET BACK ONLY

ADD LIGHT OPTIONS TO A PART NUMBER

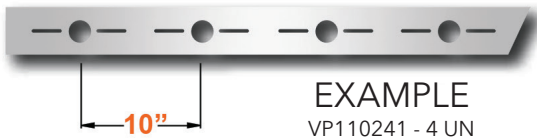

EXAMPLE
VP110241 - 4 UN

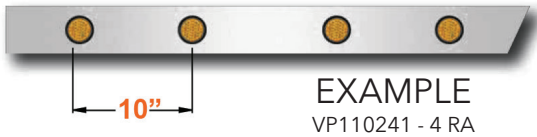

EXAMPLE
VP110241 - 4 RA



EXAMPLE
VP110241 - 5 RN



EXAMPLE
VP110241 - 4 GA

ADD LIGHTS TO YOUR PANEL - SEE PAGES 106-107



STAINLESS ACCESSORIES

PETERBILT MODEL 365 & 367

SLEEPER PANELS 4"

MOUNTING HARDWARE INCLUDED
MATCH TO SLEEPER EXTENSION PANELS ON NEXT PAGE



VP142064

PB SLEEPER PANELS - 367,
365 - 36"/44" - BLANK



VP142065

PB SLEEPER PANELS - 367,
365 - 48"/58" - BLANK



VP142066

PB SLEEPER PANELS - 367,
365 - 63"/72" - BLANK



VP142067

PB SLEEPER PANELS - 367,
365 - 70"/78" - BLANK

ADD LIGHT OPTIONS:



EXAMPLE
VP142065 - 5 UN



EXAMPLE
VP142065 - 5 RN



EXAMPLE
VP142067 - 8 RA

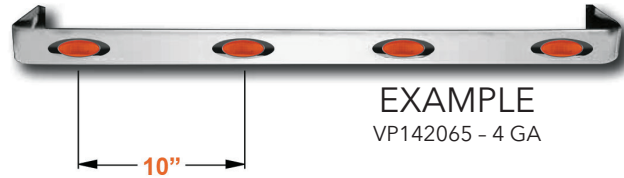

EXAMPLE
VP142065 - 4 GA

ADD LIGHTS TO YOUR PANEL - SEE PAGES 106-107

Peterbilt Truck Models	Original Sleeper Length Designation	New Sleeper Length Designation
365, 367, 379, 384, 386, 388, 389	36"	44"
	48"	58"
	63"	72"
	70"	78"



STAINLESS ACCESSORIES

PETERBILT MODEL 365 & 367

SLEEPER EXTENSION PANELS 4"

MOUNTING HARDWARE INCLUDED

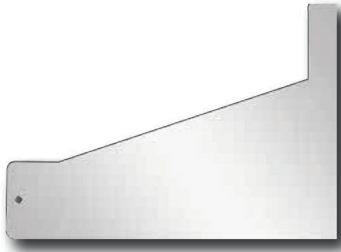

VP142101
PB SLEEPER EXTENSION
PANEL - 1987 & NEWER - 384,
379, 388, 389 - 63"/72" - BLANK,
365, 367

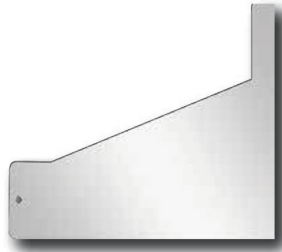

VP142103
PB SLEEPER EXTENSION
PANEL - 1987 & NEWER - 384,
379, 388, 389 - 70"/78" - BLANK,
365, 367



ADD LIGHT OPTIONS:

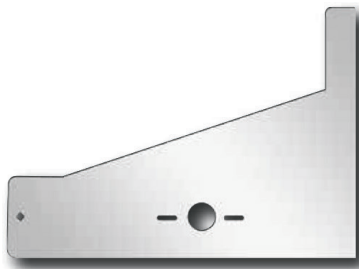

EXAMPLE
VP142101-1UN

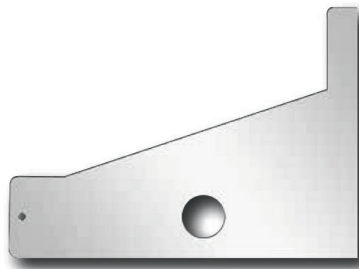

EXAMPLE
VP142101-1RN



EXAMPLE
VP142101-1GA

ADD LIGHTS TO YOUR PANEL - SEE PAGES 106-107

Peterbilt Truck Models	Original Sleeper Length Designation	New Sleeper Length Designation
365, 367, 379, 384, 386, 388, 389	36"	44"
	48"	58"
	63"	72"
	70"	78"

STAINLESS ACCESSORIES

PETERBILT MODEL 365 & 367

AIR CLEANER LIGHT BOXES

CONNECTS TO AIR CLEANER STRAP



VP112118

PB - AIR CLEANER LIGHTS - BLANK - 367, 365 - 2005 & NEWER - SET BACK AXLE ONLY - PAIR

CUSTOM EXAMPLE:



VP112118-4RA

PB - AIR CLEANER LIGHTS - 4 ROUND AMBERS - 367, 365 - 2005 & NEWER - SET BACK AXLE ONLY - PAIR

Don't Forget the Light Harness:



VHMS3007

1 - PACCAR - FEMALE 2 - PACCAR - MALE - FOR CONNECTING FRONT & REAR AIR CLEANER LIGHTS

ADD LIGHTS TO YOUR PANEL - SEE PAGES 106-107

BUG SHIELDS



VP120110

PB BUG SHIELD - STAINLESS - 367, 388, 389

MOUNTING HARDWARE INCLUDED



STAINLESS ACCESSORIES

PETERBILT MODELS 379 & 389



- 1 VP132002P** Gangster visor, 12", paintable
- 2 VP110018** Windshield trim kit -large
- 3 VP120502** Front blinker bars (pair) with LEDs
Similar: VP120501 for model 379
- 4 VP110228** Cab panels -extended wrap
Shown with four slotted light holes (VP110228-4S)
- 5 VP110308** Hood extension panel - wide replacement
Shown with three slotted light holes (VP110308-3S)
- 6 VP150011R** Fuel tank fairings (pair), rounded style, 64" long
- 7 VP142000** 4" sleeper panels (pair) for 63"/72" sleeper
Shown with five slotted light holes (VP142000-5S),
6" wide also available
- 8 VP150109R** Rear tool box with locks, smooth stainless, rounded look
- 9 911** Turbousing for flat top / cabover
- 10 HV-XXXX-58-6BB-L01-UST** Front chrome bumper, boltless,
22" American Eagle, 6 slotted light hole
Multiple other stock & custom bumpers available



**SEE PAGES 155-177
FOR MODEL 389
ACCESSORIES**

STAINLESS ACCESSORIES

PETERBILT MODEL 379

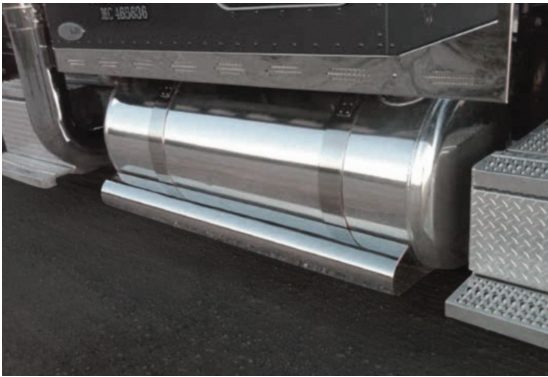

VC VALLEY
CHROME
PLATING

STAINLESS ACCESSORIES

PETERBILT MODEL 379 ONE-PIECE CAB/HOOD EXTENSION PANELS

MOUNTING HARDWARE INCLUDED

VP116401

PB CAB & WIDE REPLACEMENT
PANEL - ONE PIECE - 379 -
4" - BLANK



VP116402

PB CAB & WIDE REPLACEMENT
PANEL - ONE PIECE - WRAP - 379 -
4" - BLANK

VP116201

PB CAB & WIDE REPLACEMENT
PANEL - ONE PIECE - 379 - 6" -
BLANK



VP116202

PB CAB & WIDE REPLACEMENT
PANEL - ONE PIECE - WRAP - 379
- 6" - BLANK

PETERBILT MODEL 389 ONE-PIECE CAB/HOOD EXTENSION PANELS

MOUNTING HARDWARE INCLUDED

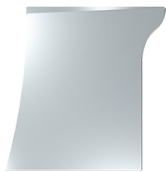

VP110368

PB 389, NO DEF, WIDE HOOD PAN-
EL ('08-NEW)

STAINLESS ACCESSORIES

PETERBILT MODEL 379



CAB PANELS 4"

MOUNTING HARDWARE INCLUDED

VP110203

PB CAB PANELS - 1987 &
NEWER - 379, 388, 389 -
STANDARD - BLANK - PAIR

VP110207

PB CAB PANELS - 1987 &
NEWER - 379, 388, 389 -
EXTENDED - BLANK - PAIR

VP110227

PB CAB PANELS - 1987 &
NEWER - 379, 388, 389 -
STANDARD WRAP - BLANK - PAIR

VP110228

PB CAB PANELS - 1987 &
NEWER - 379, 388, 389 -
EXTENDED WRAP - BLANK - PAIR

ADD LIGHTS TO YOUR PANEL - SEE PAGES 106-107

CAB PANELS 6"

MOUNTING HARDWARE INCLUDED

VP110250

PB CAB PANELS - 1987 &
NEWER - 379, 388, 389 -
STANDARD - BLANK - PAIR

VP110251

PB CAB PANELS - 1987 &
NEWER - 379, 388, 389 -
EXTENDED - BLANK - PAIR

VP110254

PB CAB PANELS - 1987 &
NEWER - 379, 388, 389 -
EXTENDED WRAP - BLANK - PAIR

VP110253

PB CAB PANELS - 1987 &
NEWER - 379, 388, 389 -
STANDARD WRAP - BLANK - PAIR

ADD LIGHT OPTIONS:

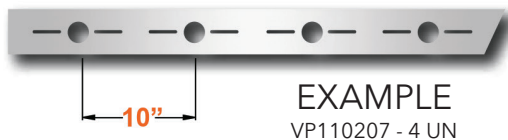

STAINLESS ACCESSORIES

PETERBILT MODEL 379

HOOD EXTENSION PANELS 4"

MOUNTING HARDWARE INCLUDED (excl. VP110310)



VP110300

PB 379 - HOOD EXTENSION
PANEL - FACTORY
REPLACEMENT



VP110310

PB 379 - HOOD EXTENSION
PANEL - FACTORY
LAYOVER
TAPE MOUNT



VP110301

PB 379 - HOOD EXTENSION
PANEL - WIDE REPLACEMENT
- BLANK - PAIR

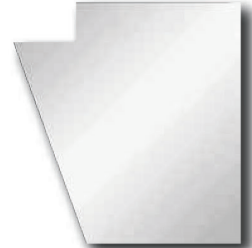

VP110303

PB 379 - HOOD EXTENSION
PANEL - WIDE REPLACEMENT
NOTCHED - BLANK - PAIR

ADD LIGHTS TO YOUR PANEL - SEE PAGES 106-107

HOOD EXTENSION PANELS 6"

MOUNTING HARDWARE INCLUDED



VP110350

PB 379 - HOOD EXTENSION
PANEL - FACTORY
REPLACEMENT



VP110352

PB 379 - HOOD EXTENSION
PANEL - WIDE REPLACEMENT
- BLANK - PAIR

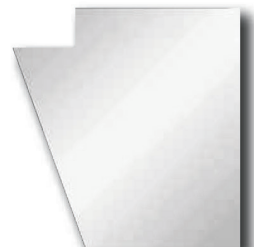

VP110358

PB 379 - HOOD EXTENSION
PANEL - WIDE REPLACEMENT
NOTCHED - BLANK - PAIR

ALL NOTCHED HOOD EXTENSION PANELS TAKE A STANDARD CAB PANEL
ALL WIDE HOOD EXTENSION PANELS TAKE AN EXTENDED CAB PANEL

STAINLESS ACCESSORIES

PETERBITL MODEL 379

SLEEPER PANELS 4"

MOUNTING HARDWARE INCLUDED
MATCH TO SLEEPER EXTENSION PANELS ON NEXT PAGE



VP142004

PB SLEEPER PANELS - 1987 &
NEWER - 379, 388, 389 - 36"/44"
- BLANK - PAIR



VP142007

PB SLEEPER PANELS - 1987 &
NEWER - 379, 388, 389 - 48"/58"
- BLANK - PAIR



VP142000

PB SLEEPER PANELS - 1987 &
NEWER - 379, 388, 389 - 63"/72"
- BLANK - PAIR



VP142002

PB SLEEPER PANELS - 1987 &
NEWER - 379, 388, 389 - 70"/78"
- BLANK - PAIR

ADD LIGHT OPTIONS



EXAMPLE
VP142002 - 8 RA

8"



EXAMPLE
VP142007 - 4 GA

10"

ADD LIGHTS TO YOUR PANEL - SEE PAGES 106-107

SLEEPER PANELS 6"

MOUNTING HARDWARE INCLUDED
MATCH TO SLEEPER EXTENSION PANELS ON NEXT PAGE



VP142050

PB SLEEPER PANELS - 1987 &
NEWER - 379, 388, 389 - 36"/44"
- BLANK - PAIR



VP142051

PB SLEEPER PANELS - 1987 &
NEWER - 379, 388, 389 - 48"
- BLANK - PAIR



VP142052

PB SLEEPER PANELS - 1987 &
NEWER - 379, 388, 389 - 63"/72"
- BLANK - PAIR



VP142053

PB SLEEPER PANELS - 1987 &
NEWER - 379, 388, 389 - 70"/80"
- BLANK - PAIR

Peterbilt Truck Models	Original Sleeper Length Designation	New Sleeper Length Designation
365, 367, 379, 384, 386, 388, 389	36"	44"
	48"	58"
	63"	72"
	70"	78"

STAINLESS ACCESSORIES

PETERBILT MODEL 379

SLEEPER EXTENSION PANELS 4"

MOUNTING HARDWARE INCLUDED

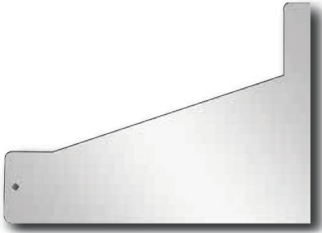

VP142101

PB SLEEPER EXTENSION
PANEL - 1987 & NEWER - 379,
388, 389 - 63"/72" - BLANK

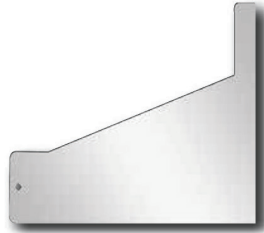

VP142103

PB SLEEPER EXTENSION
PANEL - 1987 & NEWER - 379,
388, 389 - 70"/78" - BLANK



ADD LIGHTS TO YOUR PANEL - SEE PAGES 106-107

SLEEPER EXTENSION PANELS 6"

MOUNTING HARDWARE INCLUDED

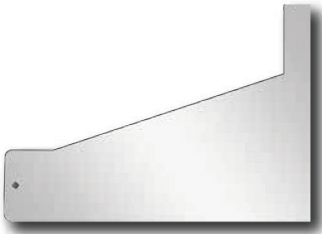

VP142150

PB SLEEPER EXTENSION
PANEL - 1987 & NEWER - 379,
388, 389 - 63"/72" - BLANK

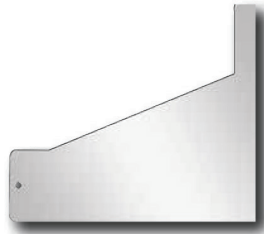

VP142151

PB SLEEPER EXTENSION
PANEL - 1987 & NEWER - 379,
388, 389 - 70"/78" - BLANK



Peterbilt Truck Models	Original Sleeper Length Designation	New Sleeper Length Designation
365, 367, 379, 384, 386, 388, 389	36"	44"
	48"	58"
	63"	72"
	70"	78"

STAINLESS ACCESSORIES

PETERBILT MODEL 379

AIR CLEANER LIGHT BOXES VORTOX

CONNECT TO AIR CLEANER STRAPS:



VP110109
PB - AIR CLEANER
LIGHTS - BLANK - 377, 378,
379 - 1987 & NEWER - PAIR -
VORTOX - FRONT

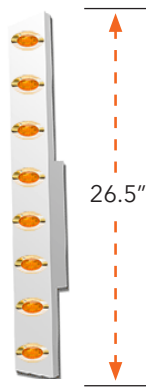

VP113108
PB - AIR CLEANER
LIGHTS - REAR -
BLANK - 377, 378, 379 -
1987 & NEWER - PAIR -
VORTOX - REAR

FOR STRAPLESS LOOK:



VP112209
PB - AIR CLEANER SUPPORT - BLANK -
379, 388, 389 - 2007 & NEWER - PAIR

ADD LIGHTS TO YOUR PANEL - SEE PAGES 106-107

EXAMPLE



VP110109-8RA
PB - AIR CLEANER LIGHTS - 8 ROUND
AMBERS - 377, 378, 379 - 1987 & NEWER -
PAIR - VORTOX



Don't Forget the
Light Harness:



VHMS3007
1 - PACCAR - FEMALE 2 - PACCAR - MALE
- FOR CONNECTING FRONT & REAR AIR
CLEANER LIGHTS

STAINLESS ACCESSORIES

PETERBILT MODEL 379

MIRROR LIGHT BOXES



VP114011
MIRROR LIGHT BOXES - 379,
388, 389 - CAB MOUNTED
MIRRORS - BLANK



ADD -SM WITH BUILT IN SPOT MIRRORS

ADD LIGHTS TO YOUR PANEL - SEE PAGES 106-107

EXAMPLES:



VP114011-2GA
MIRROR LIGHT BOXES - 379,
388, 389 - CAB MOUNTED
MIRRORS - 2 - GRANITE -
AMBER LEDS



VP114011-5RCA
MIRROR LIGHT BOXES - 379,
388, 389 - CAB MOUNTED
MIRRORS - 5 - 2" ROUNDS -
CLEAR AMBER LEDS



VP114011-2SCA
MIRROR LIGHT BOXES - 379,
388, 389 - CAB MOUNTED
MIRRORS - 2 - SLOTTED -
CLEAR AMBER LEDS



VP114011-5RA
MIRROR LIGHT BOXES - 379,
388, 389 - CAB MOUNTED
MIRRORS - 5 - 2" ROUNDS -
AMBER LEDS

STAINLESS ACCESSORIES

PETERBILT MODEL 379

BUMPER & GRILLE TRIM



VP120001
PB 1 TAG HANGER
INCLUDES HARDWARE, FOAM
PROTECTORS AND PLASTIC
LICENSE PLATE BOLT INSERTS



VP120004
PB TOW PIN COVER - 378, 379 -
1987 & NEWER
MOUNTING HARDWARE
INCLUDED



VP120201
PB 379 LONG NOSE GRILL -
HORIZONTAL - RIVETED
MOUNTING HARDWARE
INCLUDED



VP120012
PB SIDE GRILL
DEFLECTOR
379, 388, 389

SEE PAGE 95 FOR MORE TAG HANGERS

FENDER GUARDS



VP120005
PB FENDER GUARDS - FITTED
- 379 - 1987 & NEWER - 2PC



VP120006
PB FENDER GUARDS -
ROLLED, BOLT - THROUGH -
379 - 1987 & NEWER - 2PC

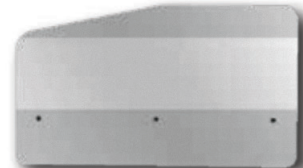

VP120007
PB FENDER GUARDS - PLAIN -
378, 379 - 1987 & NEWER

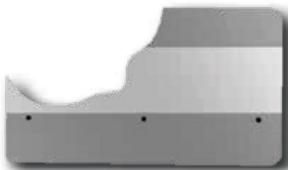

VP120009
PB FENDER GUARDS -
PLAIN - 378, 379 - 1987 &
NEWER W/JJ CUTOUT

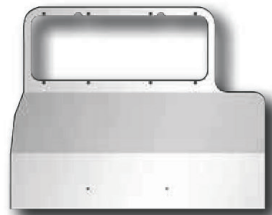

VP120010
PB FENDER GUARDS - PB -
DOUBLE HEAD LIGHT MOUNT - 378, 379
- 1987 & NEWER - 2PC



VP120011
PB FENDER GUARDS - SINGLE
HEAD LIGHT MOUNT -
378, 379 - 1987 & NEWER

STAINLESS ACCESSORIES

PETERBILT MODEL 379

BUG SHIELDS

MOUNTING HARDWARE INCLUDED



VP120103
PB BUG SHIELD TRIM ONLY
(HIGHLIGHT) - 379 ONLY
STAINLESS STEEL



VP120105
PB BUG SHIELD TRIM ONLY
(FLAMES) - 379 ONLY
STAINLESS STEEL



VP120106
PB BUG SHIELD - STAINLESS -
379 - LONG HOOD



VP120107
PB BUG SHIELD - STAINLESS
- 357, 378, 385, 379 -
SHORT HOOD



STAINLESS ACCESSORIES

PETERBILT MODEL 379

BLINKER BARS

RUBBER TRIM AND MOUNTING HARDWARE INCLUDED



VP120501

PB 379 FRONT BLINKER BARS
- W/ LEDS - PAIR
NOTE: ALREADY HAS SLOTTED
LIGHT HOLES AND LIGHTS, NO
NEED TO BUILD CUSTOM

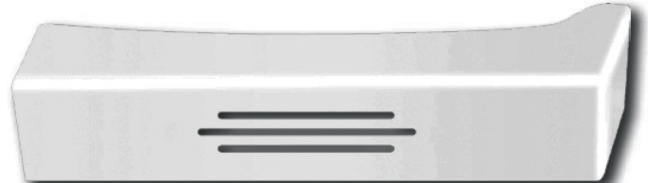

VP100501

PB 379 REAR BLINKER BARS -
- W/ LEDS - PAIR
NOTE: ALREADY HAS SLOTTED
LIGHT HOLES AND LIGHTS, NO
NEED TO BUILD CUSTOM



VP120501BL

PB 379 FRONT BLINKER BARS
- W/ LEDS - PAIR
NO LIGHT HOLES
ADD LIGHTS TO YOURS,
SEE PAGES 106 -107

FENDER SUPPORT COVERS

RUBBER TRIM AND MOUNTING HARDWARE INCLUDED



VP120505

PB 379 FENDER SUPPORT
COVER - FRONT - BLANK

STAINLESS ACCESSORIES

PETERBILT MODEL 379

SLEEPER FILLER PANELS

MOUNTING HARDWARE INCLUDED



VP140021
PB SLEEPER REAR CORNER
FILLER PANELS 70" ONLY -
379, 389 - 4 - 4" LEDS - PAIR

SLEEPER SHOCK COVERS

RUBBER STRIP & HARDWARE INCLUDED



VP140034
PB SLEEPER SHOCK COVERS
- 379, 389 - 2 PCS (L+R)
ANGLED
TAPE MOUNT



VP140022
PB 379, 389 SLEEPER SHOCK
COVERS - 2 PAIR
TAPE MOUNT

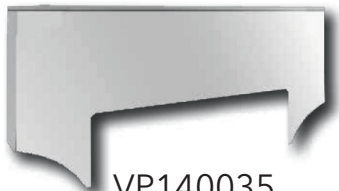
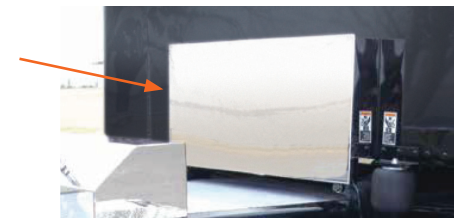
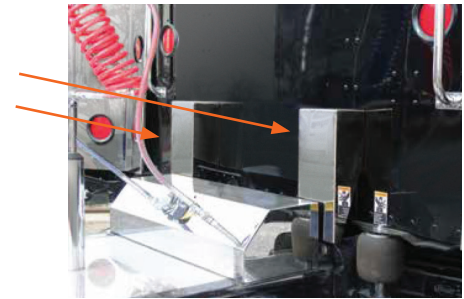

VP140035
PB SLEEPER SHOCK COVER -
379,389 ANGLED FULL COVER

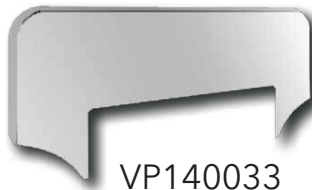

VP140033
PB SLEEPER SHOCK COVERS
- 379,389 - 1 LG CURVED FULL COVER

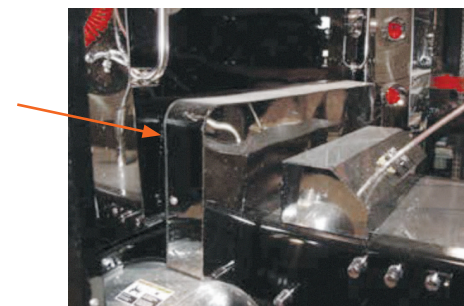

RUBBER STRIP & HARDWARE INCLUDED

STAINLESS ACCESSORIES

PETERBILT MODEL 379

AIR DEFLECTORS

VP110016

PB 359 - 379, 389 WINDOW AIR
DEFLECTORS
TAPE MOUNT



VP110031

PB 359 - 379, 389 WINDOW
AIR DEFLECTORS W/LOWER
LOOKS(VP110017)WINDOW
TRIM 37.25" X 20.375"
TAPE MOUNT



FUEL TANK STRAP COVERS

BRACKETS & MOUNTING HARDWARE INCLUDED



VP150020

PB - FUEL TANK STRAP
COVERS - 4PCS



VP150029

PB - FUEL TANK STRAP
COVERS - 2PCS
NOT 359

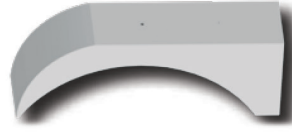

VP150029R

PB - FUEL TANK STRAP
COVERS - ROUND - 2PCS
ALL BUT 359



STAINLESS ACCESSORIES

PETERBILT MODEL 379

FUEL TANK FAIRINGS

BRACKETS & HARDWARE INCLUDED
NOT AVAILABLE 430 STAINLESS

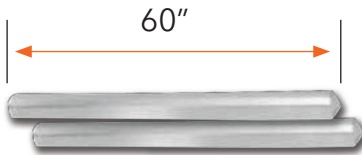

VP150010

PB - FUEL TANK FAIRINGS 60"
379 - 1987 & NEWER - PAIR



VP150011

PB - FUEL TANK FAIRINGS 64"
379 - 1987 & NEWER - PAIR



VP150012

PB - FUEL TANK FAIRINGS 66"
379 - 1987 & NEWER - PAIR

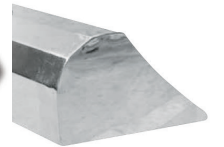

STANDARD



VP150010R

PB - FUEL TANK FAIRINGS
60" 379 - 1987 & NEWER - PAIR
ROUND



VP150011R

PB - FUEL TANK FAIRINGS
64" 379 - 1987 & NEWER - PAIR
ROUND



VP150012R

PB - FUEL TANK FAIRINGS
66" 379 - 1987 & NEWER - PAIR
ROUND



ROUNDED



VP150010W

PB - FUEL TANK FAIRINGS
60" 379 - 1987 & NEWER - PAIR -
WING LOOK



VP150011W

PB - FUEL TANK FAIRINGS
64" 379 - 1987 & NEWER - PAIR -
WING LOOK



VP150012W

PB - FUEL TANK FAIRINGS
66" 379 - 1987 & NEWER - PAIR -
WING LOOK



WING LOOK

ADD LIGHTS TO YOUR PANEL - SEE PAGES 106-107



EXAMPLE:

VP150012-5GA

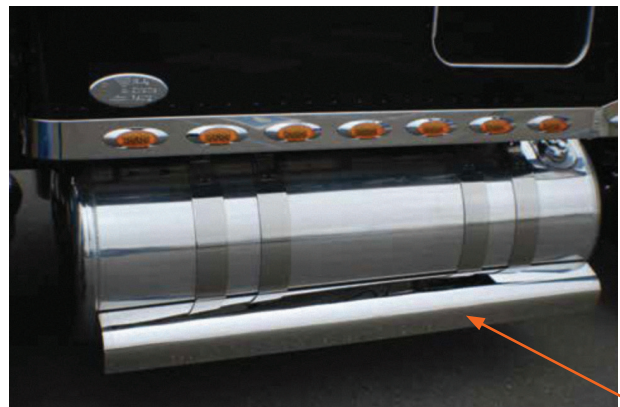

STAINLESS ACCESSORIES

PETERBILT MODEL 379

EMBLEMS



VP100009
EMBLEM ACCENT PB 379
RACING STRIPE - 2PC



VP100028
EMBLEM ACCENT PB 379 -
RACING STRIPE - LONG - PAIR

MISC. TRIM PIECES



VP100021
PB 379 FENDER TRIM
INNER WELL - 2PC

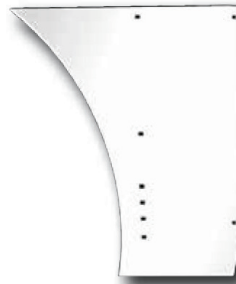

VP100020
PB LOWER HOOD PANEL
EXTENDED HOOD - 379 1987
& NEWER - 2PC



VP100025
PB 379 CENTER HOOD TRIM
EXTENDED HOOD



VP100026
PB 379 FENDER TRIM - 2PC



VP110012
359, 379 DOOR FLAME
TRIM - PAIR



VP110018
PB WINDSHIELD TRIM - 5 PC
379, 389 - LARGE



VP110015
PB CENTER EXT WINDSHIELD
TRIM - 377, 378, 379

STAINLESS ACCESSORIES

PETERBILT MODEL 379

MISC TRIM PIECES



VP110022

PB 379 TOP OF DOOR TRIM - LOWERED LOOK - 73-04 - DOOR
MOUNTED MIRRORS - PR
TAPE MOUNT

CUSTOM HEIGHTS AVAILABLE



VP110022P FOR PAINTABLE



VPTFI8021

PB OUTER FENDER
TRIM - 379
INCLUDES SET SCREWS
SOLD AS SET OF 3 PAIR

VPTFI8021S
FOR ONE PAIR



VP110025

PB 379, 388, 389 WINDSHIELD WIPER
ARM COVERS
TAPE MOUNT

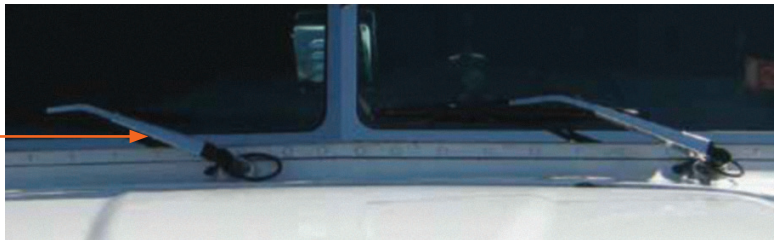

STAINLESS ACCESSORIES

PETERBILT MODEL 379

BATTERY BOXES & TOOL BOXES

STANDARD WIDTH 30" / CUSTOM WIDTHS AVAILABLE UP TO 48"

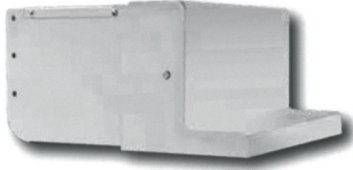

VP150112 - PB - 379,388, 389 REAR TOOL BOX - STAINLESS W/LOCKS - ROUNDED MOULDED LID

VP150113 - PB - 379, 388, 389 BATTERY BOX - STAINLESS W/LOCKS - ROUNDED MOULDED LID

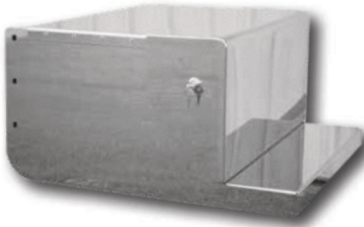

VP150109R - PB - 379, 388, 389 REAR TOOL BOX - STAINLESS W/LOCKS - ROUNDED SMOOTH LOOK

VP150110R - PB - 379, 388, 389 BATTERY BOX - STAINLESS W/LOCKS - ROUNDED SMOOTH LOOK

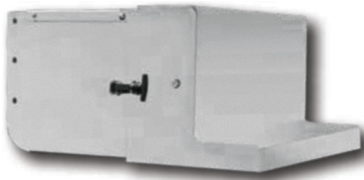

VP150115 - PB - 379,388, 389 REAR TOOL BOX - STAINLESS W/LOCKS - MOULDED LID

VP150116 - PB - 379, 388, 389 BATTERY BOX - STAINLESS W/LOCKS - MOULDED LID

VP150116TM - PB - 379, 388, 389 BATT, BOX - STAINLESS W/TIE DOWNS - 18" TALL MOLDED LID

ADD -36 TO ANY STAINLESS TOOL BOX PART NUMBER FOR A 36" BOX
ADD -48 TO ANY STAINLESS TOOL BOX PART NUMBER FOR A 48" BOX

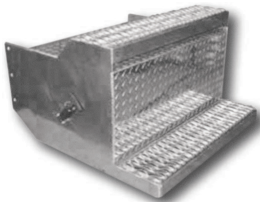

VP150103

PB - 379, 388, 389 BATTERY BOX - ALUMINUM



VP150104

PB - 379, 388, 389 BATTERY BOX - ALUMINUM



BOX STEP HIGHLIGHTS/PROTECTORS



VP150030

PB TOOL BOX/BATTERY BOX - STEP PROTECTOR-(18") - WICKED PR

VP150031

PB TOOL BOX/BATTERY BOX - STEP PROTECTOR-(30") WICKED PAIR

PAINTED OPTIONS SHOWN



STAINLESS ACCESSORIES

PETERBILT MODEL 379 TOOL & BATTERY BOX COVERS

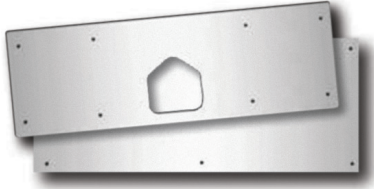

VP150002
PB TOOL & BATTERY BOX
COVER 1993 & NEWER - 2 PC.



VP150003
PB BATTERY BOX COVER 378,
379 - 12" X 30" - 1993 & NEWER



VP150004
PB TOOL BOX COVER 378, 379
- 10" X 30" - 1993 & NEWER



VP150015
PB TOOL BOX COVER -
W/ 1" LIP ON TOP - 378, 379



VP150016
PB 379 BATTERY BOX COVER -
W/ 1" LIP ON TOP

PETERBILT MODEL 379 TAG & LICENSE PLATE HANGERS ALSO FITS MODEL 389

VP120021

PB WIDE TAG/LIC PLATE HANGER
INCLUDES HARDWARE, FOAM PROTECTORS & PLASTIC LICENSE
PLATE BOLT INSERTS

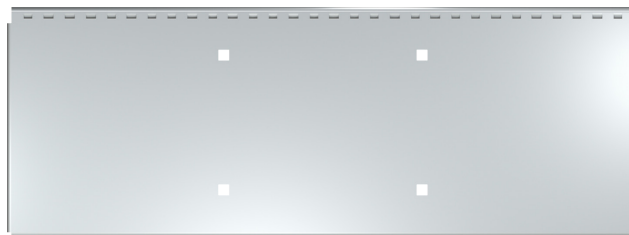
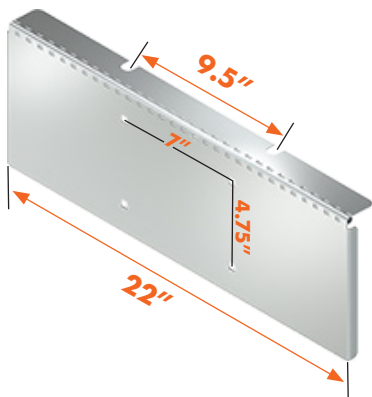

AVAILABLE WITH 2 WATERMELON
LIGHTS INSTALLED
(VP120021-2WA SHOWN)

STAINLESS ACCESSORIES

PETERBILT MODEL 384



Bumpers and Stainless Accessories made in the USA



www.valleychrome.com

STAINLESS ACCESSORIES

PETERBILT MODEL 384

CAB PANELS 4"

MOUNTING HARDWARE INCLUDED



VP110338

PB CAB PANELS - 384 - STANDARD -
BLANK - WRAP PAIR

ADD LIGHTS TO YOUR PANEL - SEE PAGES 106-107

CAB PANELS 6"

MOUNTING HARDWARE INCLUDED



VP110252

PB CAB PANELS - 384 -
STANDARD - BLANK - PAIR



VP110353

PB CAB PANELS - 384 - STANDARD -
BLANK - WRAP - PAIR

ADD LIGHT OPTIONS:



10"

EXAMPLE
VP110252 - 4 UN



8"

EXAMPLE
VP110252 - 5 RN

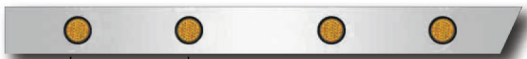

10"

EXAMPLE
VP110252 - 4 RA



10"

EXAMPLE
VP110252 - 3 GA

STAINLESS ACCESSORIES

PETERBILT MODEL 384

SLEEPER PANELS 4"

MOUNTING HARDWARE INCLUDED
MATCH TO SLEEPER EXTENSION PANELS ON NEXT PAGE



VP142060
PB SLEEPER PANELS - 384
- 36"/44" - NOTCHED FOR
EXHAUST - BLANK



VP142061
PB SLEEPER PANELS - 384 -
48"/58" - NOTCHED FOR EXHAUST
- BLANK



VP142062
PB SLEEPER PANELS - 384
- 63"/72" - NOTCHED FOR
EXHAUST - BLANK



VP142063
PB SLEEPER PANELS - 384
- 70"/78" - NOTCHED FOR
EXHAUST - BLANK

ADD LIGHTS TO YOUR PANEL - SEE PAGES 106-107

SLEEPER PANELS 6"

MOUNTING HARDWARE INCLUDED
MATCH TO SLEEPER EXTENSION PANELS ON NEXT PAGE



VP142160
PB SLEEPER PANELS - 384
- 36"/44" - NOTCHED FOR
EXHAUST - BLANK



VP142161
PB SLEEPER PANELS - 384 -
48"/58" - NOTCHED FOR EXHAUST
- BLANK



VP142162
PB SLEEPER PANELS - 384
- 63"/72" - NOTCHED FOR
EXHAUST - BLANK



VP142163
PB SLEEPER PANELS - 384
- 70"/78" - NOTCHED FOR
EXHAUST - BLANK

ADD LIGHT OPTIONS



EXAMPLE
VP142063 - 8 RA

8"



EXAMPLE
VP142060 - 4 GA

10"

Peterbilt Truck Models	Original Sleeper Length Designation	New Sleeper Length Designation
365, 367, 379, 384, 386, 388, 389	36"	44"
	48"	58"
	63"	72"
	70"	78"

STAINLESS ACCESSORIES

PETERBILT MODEL 384

SLEEPER EXTENSION PANELS 4"

MOUNTING HARDWARE INCLUDED

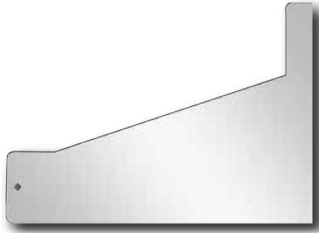

VP142101
PB SLEEPER EXTENSION
PANEL - 1987 & NEWER - 379,
388, 389 - 63"/72" - BLANK

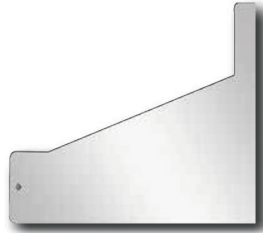

VP142103
PB SLEEPER EXTENSION
PANEL - 1987 & NEWER - 379,
388, 389 - 70"/78" - BLANK



ADD LIGHTS TO YOUR PANEL - SEE PAGES 106-107

SLEEPER EXTENSION PANELS 6"

MOUNTING HARDWARE INCLUDED

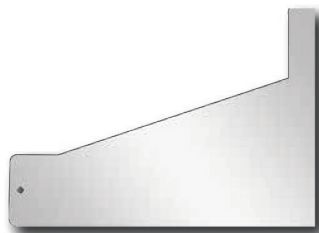

VP142150
PB SLEEPER EXTENSION
PANEL - 1987 & NEWER - 379,
388, 389 - 63"/72" - BLANK

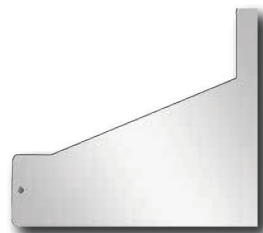

VP142151
PB SLEEPER EXTENSION
PANEL - 1987 & NEWER - 379,
388, 389 - 70"/78" - BLANK



Peterbilt Truck Models	Original Sleeper Length Designation	New Sleeper Length Designation
365, 367, 379, 384, 386, 388, 389	36"	44"
	48"	58"
	63"	72"
	70"	78"

BUG SHIELDS



VP120111
PB BUG SHIELD - STAINLESS - 384
MOUNTING HARDWARE INCLUDED

STAINLESS ACCESSORIES

PETERBILT MODEL 386



Bumpers and Stainless Accessories made in the USA



www.valleychrome.com

STAINLESS ACCESSORIES

PETERBILT MODEL 386

CAB PANELS 2.5"

MOUNTING HARDWARE INCLUDED



VP110200
PB CAB PANELS - 2005 &
NEWER - 386 - BLANK

ADD LIGHTS TO YOUR PANEL - SEE PAGES 106-107

EXHAUST FILLER PANEL 2.5"

MOUNTING HARDWARE INCLUDED



VP110205
PB EX HAUST FILLER PANEL -
386 - BLANK - PAIR

ADD LIGHT OPTIONS:

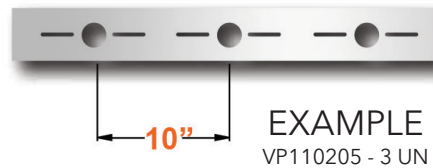

386 PANELS ARE ONLY 2.5" WIDE AND CAN ONLY USE GRANITE, PETERBILT AND UNIVERSAL CUT OUTS.

STAINLESS ACCESSORIES

PETERBILT MODEL 386

SLEEPER PANELS 2.5"

MOUNTING HARDWARE INCLUDED
MATCH TO SLEEPER EXTENSION PANELS ON NEXT PAGE



VP142008

PB SLEEPER PANELS - 1987 &
NEWER - 386 - 36"/44" -
BLANK - PR



VP142009

PB SLEEPER PANELS - 1987 &
NEWER - 386 - 48"/58" -
BLANK - PR



VP142010

PB SLEEPER PANELS - 1987 &
NEWER - 386 - 63"/72" -
BLANK - PR



VP142011

PB SLEEPER PANELS - 1987 &
NEWER - 386 - 70"/78" -
BLANK - PR

ADD LIGHTS TO YOUR PANEL - SEE PAGES 106-107

ADD LIGHT OPTIONS

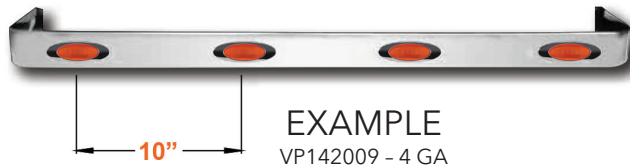

EXAMPLE
VP142009 - 4 GA

386 PANELS ARE ONLY 2.5" WIDE AND CAN ONLY USE GRANITE, PETERBILT AND UNIVERSAL CUT OUTS.

Peterbilt Truck Models	Original Sleeper Length Designation	New Sleeper Length Designation
365, 367, 379, 384, 386, 388, 389	36"	44"
	48"	58"
	63"	72"
	70"	78"

STAINLESS ACCESSORIES

PETERBILT MODEL 386

SLEEPER EXTENSION PANELS 2.5"

MOUNTING HARDWARE INCLUDED

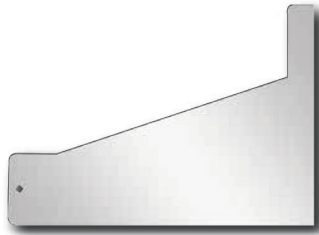

VP142111
PB SLEEPER EXTENSION
PANEL - 1987 & NEWER - 386 -
2.5" WIDE - 70"/78" - BLANK

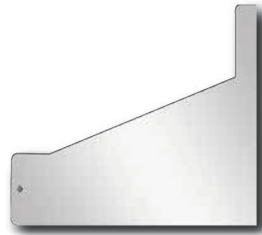

VP142112
PB SLEEPER EXTENSION PANEL
- 1987 & NEWER - 386 - 2.5" WIDE -
36,48,63"/72" - BLANK

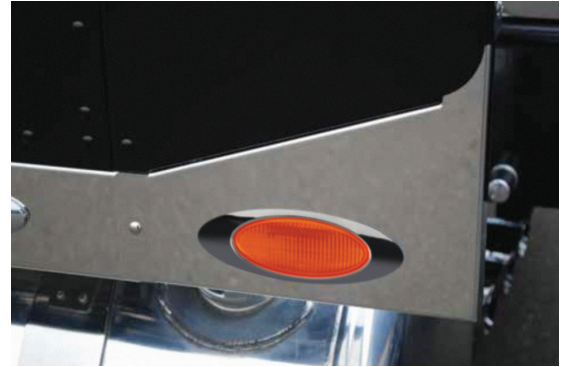

ADD LIGHTS TO YOUR PANEL - SEE PAGES 106-107

ADD LIGHT OPTIONS

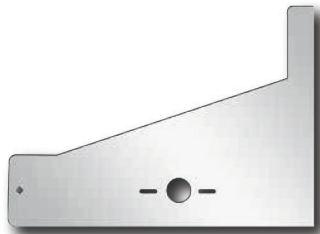

EXAMPLE
VP142112-1UN



EXAMPLE
VP142112-1GA



EXAMPLE
VP142112-1PA

386 PANELS ARE ONLY 2.5" WIDE AND CAN ONLY USE GRANITE, PETERBILT AND UNIVERSAL CUT OUTS.

Peterbilt Truck Models	Original Sleeper Length Designation	New Sleeper Length Designation
365, 367, 379, 384, 386, 388, 389	36"	44"
	48"	58"
	63"	72"
	70"	78"

BUG SHIELDS



VP120112
PB BUG SHIELD - STAINLESS - 384/386
MOUNTING HARDWARE INCLUDED

STAINLESS ACCESSORIES

PETERBILT MODELS 388 & 389



FOR 388 & 389 VISORS SEE PAGES 198-201

Bumpers and Stainless Accessories made in the USA



www.valleychrome.com

STAINLESS ACCESSORIES

PETERBILT MODEL 388 & 389

FORMED CAB PANELS 4"

MOUNTING HARDWARE INCLUDED

4" WIDE DRIVER SIDE, ALSO AVAILABLE IN 6" WIDTH
2.25" ONLY ON PASSENGER SIDE



VP114207

PB CAB PANELS - 1987 &
NEWER - 388, 389 - FORMED
EXTENDED - BLANK - PR



VP114228

PB CAB PANELS - 1987 &
NEWER - 388, 389 - FORMED
EXTENDED WRAP- BLANK - PR



VP114267

PB CAB PANELS - 389 - 2010 &
NEWER - FORMED EXTENDED
- W / UREA SYSTEM - 2.1/4"
PASSANGER SIDE - 4" DRIVERS
SIDE - BLANK

ADD LIGHTS TO YOUR PANEL - SEE PAGES 106-107

FORMED CAB PANELS 6"



VP114251

PB CAB PANELS - 1987 &
NEWER - 388, 389 - FORMED
EXTENDED - BLANK - PR



VP114253

PB CAB PANELS - 1987 &
NEWER - 388, 389 - FORMED
EXTENDED WRAP- BLANK - PR

ADD LIGHT OPTIONS:



EXAMPLE
VP114251-3GA



STAINLESS ACCESSORIES

PETERBILT MODEL 388 & 389

ONE-PIECE CAB/HOOD EXTENSION PANELS, NO DEF SYSTEM

MOUNTING HARDWARE INCLUDED

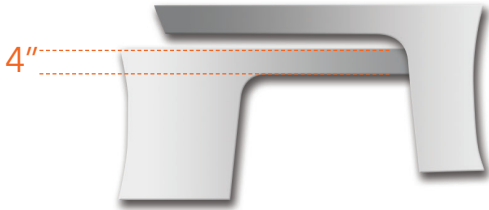

VP116400

PB CAB & WIDE REPLACEMENT
PANEL - ONE PIECE - 389
2009-2011 - NON UREA - WIDE
REPLACEMENT DRIVERS
SIDE - SMALL REPLACEMENT
PASSENGERS SIDE - 4" CAB
PANELS - BLANK

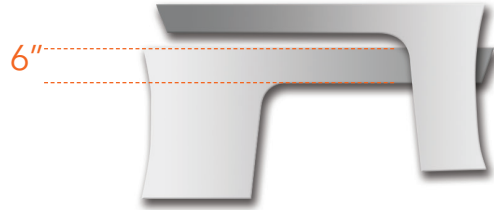

VP116200

PB CAB & WIDE
REPLACEMENT PANEL - ONE
PIECE - 389 2009-2011 - NON
UREA - WIDE REPLACEMENT
DRIVERS SIDE - SMALL
REPLACEMENT PASSENGERS
SIDE - 6" CAB PANELS - BLANK

VP116411

PB CAB & WIDE REPLACEMENT
PANEL - ONE PIECE - 389
2009-2011 - NON UREA - WIDE
REPLACEMENT DRIVERS
SIDE - SMALL REPLACEMENT
PASSENGERS SIDE - 4" CAB
PANELS - WRAP - BLANK

VP116211

PB CAB & WIDE REPLACEMENT
PANEL - ONE PIECE - 389
2009-2011 - NON UREA - WIDE
REPLACEMENT DRIVERS
SIDE - SMALL REPLACEMENT
PASSENGERS SIDE - 6" CAB
PANELS - WRAP - BLANK

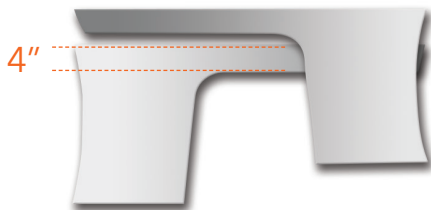

VP116420

PB CAB & WIDE REPLACEMENT PANEL
BOTH SIDES - ONE PIECE - 389 2008 -
NON UREA - 4" CAB PANELS - BLANK

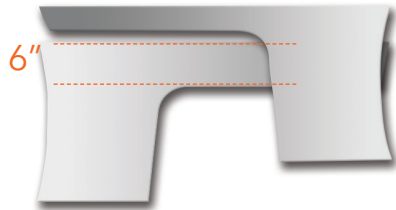

VP116420-6

PB CAB & WIDE REPLACEMENT PANEL
BOTH SIDES - ONE PIECE - 389 2008 -
NON UREA - 6" CAB PANELS - BLANK

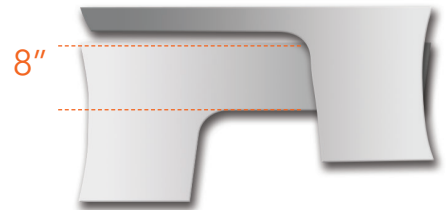

VP116420-8

PB CAB & WIDE REPLACEMENT PANEL
BOTH SIDES - ONE PIECE - 389 2008 -
NON UREA - 8" CAB PANELS - BLANK

2008-2010 WITH CAT ENGINES USE WIDE PANELS BOTH SIDES
2009-2010 CUMMINS ENGINES USE WIDE DRIVER SIDE, NARROW PASSENGER

ADD LIGHTS TO YOUR PANEL - SEE PAGES 106-107



VP116411-8GA shown

STAINLESS ACCESSORIES

PETERBILT MODEL 388 & 389

ONE-PIECE CAB/HOOD EXTENSION PANELS DEF SYSTEM

MOUNTING HARDWARE INCLUDED

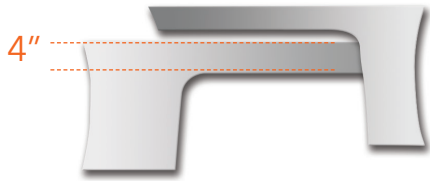

VP116421

PB CAB & WIDE REPLACEMENT PANEL - ONE PIECE - 389
 - 2010 & NEWER W/UREA SYSTEM - WIDE REPLACEMENT
 DRIVERS SIDE - SMALL REPLACEMENT PASSENGERS SIDE -
 2.1/4" CAB PANEL DRIVERS SIDE - 4" CAB PANEL PASSENGERS
 SIDE - BLANK

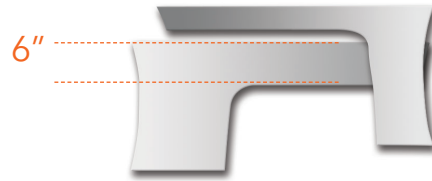

VP116425

PB CAB & WIDE REPLACEMENT PANEL - ONE PIECE - 389
 - 2010 & NEWER W/ UREA SYSTEM - WIDE REPLACEMENT
 DRIVERS SIDE - SMALL REPLACEMENT PASSENGERS SIDE -
 2.1/4" CAB PANEL DRIVERS SIDE - 6" CAB PANEL PASSENGERS
 SIDE - BLANK

2008-2010 WITH CAT ENGINES USE WIDE PANELS BOTH SIDES
 2009-2010 CUMMINS ENGINES USE WIDE DRIVER SIDE, NARROW PASSENGER

ADD LIGHTS TO YOUR PANEL - SEE PAGES 106-107

ONE-PIECE CAB/HOOD EXTENSION PANELS, NO DEF SYSTEM

FORMED PANELS • HARDWARE INCLUDED

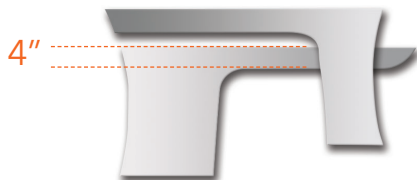

VP114400

PB CAB & WIDE REPLACEMENT
 PANEL - FORMED ONE PIECE
 - 389 2009-2011 - NON UREA -
 WIDE REPLACEMENT DRIVERS
 SIDE - SMALL REPLACEMENT
 PASSENGERS SIDE - 4" CAB
 PANELS - BLANK



VP114411

PB CAB & WIDE REPLACEMENT
 PANEL - FORMED ONE PIECE
 - 389 2009-2011 - NON UREA -
 WIDE REPLACEMENT DRIVERS
 SIDE - SMALL REPLACEMENT
 PASSENGERS SIDE - 4" CAB
 PANELS - WRAP - BLANK

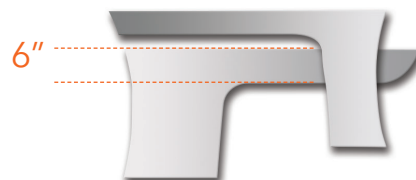

VP114200

PB CAB & WIDE REPLACEMENT
 PANEL - FORMED ONE PIECE
 - 389 2009-2011 - NON UREA -
 WIDE REPLACEMENT DRIVERS
 SIDE - SMALL REPLACEMENT
 PASSENGERS SIDE - 6" CAB
 PANELS - BLANK



VP114211

PB CAB & WIDE REPLACEMENT
 PANEL - FORMED ONE PIECE
 - 389 2009-2011 - NON UREA -
 WIDE REPLACEMENT DRIVERS
 SIDE - SMALL REPLACEMENT
 PASSENGERS SIDE - 6" CAB
 PANELS - WRAP - BLANK

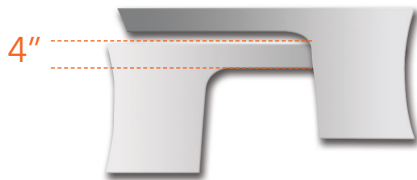

VP114420

PB CAB & WIDE REPLACEMENT PANEL BOTH SIDES
 - FORMED ONE PIECE - 389 2008 - NON UREA -
 4" CAB PANELS - BLANK

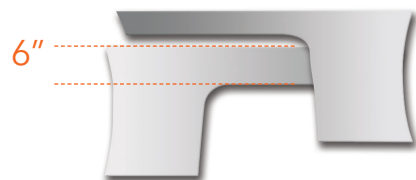

VP114420-6

PB CAB & WIDE REPLACEMENT PANEL BOTH SIDES
 - FORMED ONE PIECE - 389 2008 - NON UREA -
 6" CAB PANELS - BLANK

STAINLESS ACCESSORIES

PETERBILT MODEL 388 & 389

ONE-PIECE CAB/HOOD EXTENSION PANELS DEF SYSTEM

FORMED PANELS • HARDWARE INCLUDED

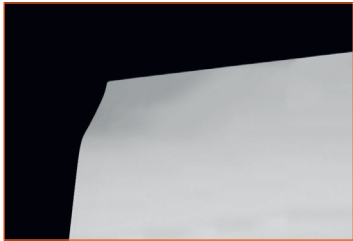

CORNER FOLLOWS
CONTOUR OF TRUCK



VP114421

PB CAB & WIDE REPLACEMENT PANEL -
FORMED ONE PIECE - 389 - 2010 & NEWER
W/ UREA SYSTEM - WIDE REPLACEMENT
DRIVERS SIDE - SMALL REPLACEMENT
PASSENGERS SIDE - 2.1/4" CAB PANEL
DRIVERS SIDE - 4" CAB PANEL
PASSENGERS SIDE - BLANK



VP114422

PB CAB & WIDE REPLACEMENT PANEL
- FORMED - ONE PIECE - 388, 389 - 2010
& NEWER W/ UREA SYSTEM - WIDE
REPLACEMENT DRIVERS SIDE - SMALL
REPLACEMENT PASSENGERS SIDE - 4"
CAB PANEL DRIVERS SIDE - 2.1/4" CAB
PANEL PASSENGERS SIDE - WRAPPED - BLANK

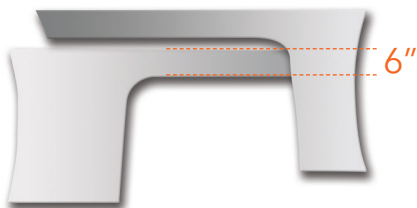

VP114425

PB CAB & WIDE REPLACEMENT PANEL -
FORMED ONE PIECE - 389 - 2010 & NEWER
W/ UREA SYSTEM - WIDE REPLACEMENT
DRIVERS SIDE - SMALL REPLACEMENT
PASSENGERS SIDE - 2.1/4" CAB PANEL
DRIVERS SIDE - 6" CAB PANEL
PASSENGERS SIDE - BLANK



VP114426

PB CAB & WIDE REPLACEMENT PANEL -
FORMED - ONE PIECE - 388, 389 - 2014 &
NEWER W/ UREA SYSTEM AND DYNAFLEX
KIT - WIDE REPLACEMENT DRIVERS SIDE -
SMALL REPLACEMENT PASSENGERS SIDE
- 4" CAB PANEL DRIVERS SIDE - 2.1/4" CAB
PANEL PASSENGERS SIDE - BLANK



VP114427

PB CAB & WIDE REPLACEMENT PANEL -
FORMED - ONE PIECE - 388, 389 - 2014 &
NEWER W/ UREA SYSTEM AND DYNAFLEX
KIT - WIDE REPLACEMENT DRIVERS SIDE -
SMALL REPLACEMENT PASSENGERS SIDE
- 4" CAB PANEL DRIVERS SIDE - 2.1/4" CAB
PANEL PASSENGERS SIDE - WRAPPED - BLANK

2008-2010 WITH CAT ENGINES USE WIDE PANELS BOTH SIDES
2009-2010 CUMMINS ENGINES USE WIDE DRIVER SIDE, NARROW PASSENGER

ADD LIGHTS TO YOUR PANEL - SEE PAGES 106-107

STAINLESS ACCESSORIES

PETERBILT MODEL 388 & 389

CAB PANELS 4"

MOUNTING HARDWARE INCLUDED

VP110203

PB CAB PANELS - 1987 &
NEWER - 379, 388, 389 -
STANDARD - BLANK - PAIR

VP110207

PB CAB PANELS - 1987 &
NEWER - 379, 388, 389 -
EXTENDED - BLANK - PAIR

VP110227

PB CAB PANELS - 1987 &
NEWER - 379, 388, 389 -
STANDARD WRAP - BLANK - PAIR

VP110228

PB CAB PANELS - 1987 &
NEWER - 379, 388, 389 -
EXTENDED WRAP - BLANK - PAIR

CAB PANELS 6"

MOUNTING HARDWARE INCLUDED

VP110250

PB CAB PANELS - 1987 &
NEWER - 379, 388, 389 -
STANDARD - BLANK - PAIR

VP110251

PB CAB PANELS - 1987 &
NEWER - 379, 388, 389 -
EXTENDED - BLANK - PAIR

VP110254

PB CAB PANELS - 1987 &
NEWER - 379, 388, 389 -
STANDARD WRAP - BLANK - PAIR

VP110253

PB CAB PANELS - 1987 &
NEWER - 379, 388, 389 -
STANDARD WRAP - BLANK - PAIR

ADD LIGHTS TO YOUR PANEL - SEE PAGES 106-107

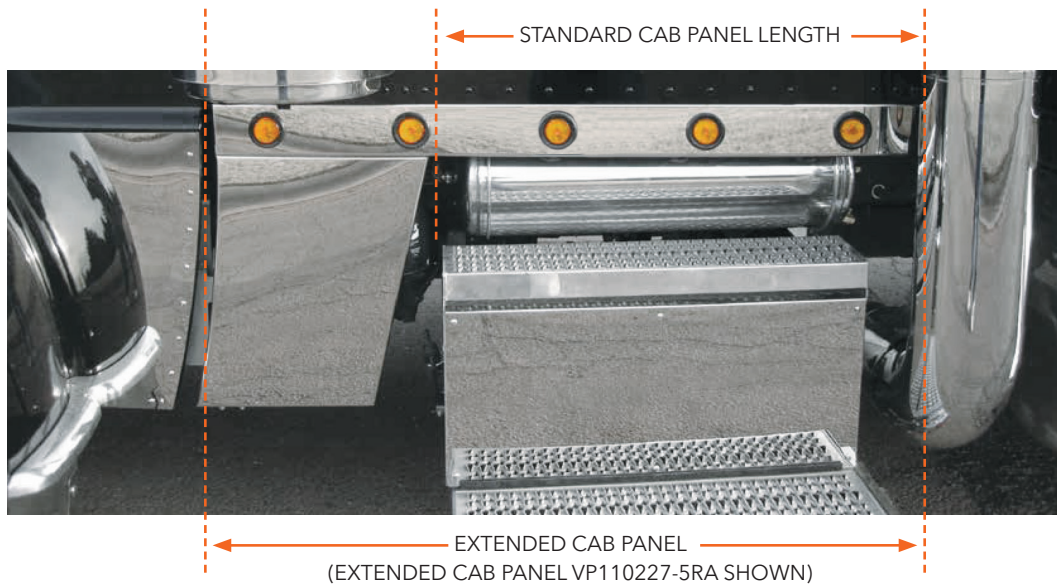

STAINLESS ACCESSORIES

PETERBILT MODEL 388 & 389

CAB PANELS NO DEF SYSTEM

MOUNTING HARDWARE INCLUDED



VP113890

PB CAB PANELS - 1987 &
NEWER - 389 - STANDARD -
BLANK - PR - 44.38" LONG



VP113891

PB CAB PANELS - 1987 &
NEWER - 389 - STANDARD
WRAP - BLANK - PR

CAB PANELS DEF SYSTEM

MOUNTING HARDWARE INCLUDED



VP110263

PB CAB PANELS - 388,389 - 2010
& NEWER - STANDARD - W / UREA
SYSTEM - 2.1/4" PASSENGER SIDE
- 4" DRIVERS SIDE - BLANK



VP110264

PB CAB PANELS - 388,389
- 2010 & NEWER - WRAP -
W / UREA SYSTEM - 2.1/4"
PASSENGER SIDE - 4"
DRIVERS SIDE - BLANK



VP110267

PB CAB PANELS - 389 - 2010 &
NEWER - EXTENDED - W / UREA
SYSTEM - 2.1/4" PASSENGER
SIDE - 4" DRIVERS SIDE - BLANK

4" WIDE DRIVER SIDE, ALSO AVAILABLE IN 6" WIDTH
2.25" ONLY ON PASSENGER SIDE

ADD LIGHTS TO YOUR PANEL - SEE PAGES 106-107

STAINLESS ACCESSORIES

PETERBILT MODEL 388 & 389

SLEEPER PANELS 4"

MOUNTING HARDWARE INCLUDED
MATCH TO SLEEPER EXTENSION PANELS ON PAGE 165



VP142004

PB SLEEPER PANELS - 1987 &
NEWER - 379, 388, 389 - 36"/44"
- BLANK - PAIR



VP142007

PB SLEEPER PANELS - 1987 &
NEWER - 379, 388, 389 - 48"/58"
- BLANK - PAIR



VP142000

PB SLEEPER PANELS - 1987 &
NEWER - 379, 388, 389 - 63"/72"
- BLANK - PAIR



VP142002

PB SLEEPER PANELS - 1987 &
NEWER - 379, 388, 389 - 70"/78"
- BLANK - PAIR

ADD LIGHTS TO YOUR PANEL - SEE PAGES 106-107

SLEEPER PANELS 6"

MOUNTING HARDWARE INCLUDED



VP142050

PB SLEEPER PANELS - 1987 &
NEWER - 379, 388, 389 - 36"/44"
- BLANK - PAIR



VP142051

PB SLEEPER PANELS - 1987 &
NEWER - 379, 388, 389 - 48"/58"
- BLANK - PAIR



VP142052

PB SLEEPER PANELS - 1987 &
NEWER - 379, 388, 389 - 63"/72"
- BLANK - PAIR



VP142053

PB SLEEPER PANELS - 1987 &
NEWER - 379, 388, 389 - 70"/78"
- BLANK - PAIR

ADD LIGHT OPTIONS



EXAMPLE
VP142002 - 8 RA

8"



EXAMPLE
VP142007 - 4 GA

10"

Peterbilt Truck Models	Original Sleeper Length Designation	New Sleeper Length Designation
365, 367, 379, 384, 386, 388, 389	36"	44"
	48"	58"
	63"	72"
	70"	78"

STAINLESS ACCESSORIES

PETERBILT MODEL 388 & 389

HOOD EXTENSION PANELS 4"

MOUNTING HARDWARE INCLUDED (EXCEPT VP110314 TAPE MOUNT)



VP110313

PB 389 - HOOD EXTENSION
PANEL - FACTORY
REPLACEMENT - PAIR



VP110314

PB 389 - HOOD EXTENSION
PANEL - FACTORY LAYOVER
- PAIR, TAPE MOUNT

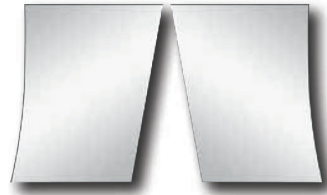

VP110308

PB 389 - HOOD EXTENSION
PANEL - WIDE REPLACEMENT
- BLANK - PAIR



VP110309

PB 389 - HOOD EXTENSION
PANEL - WIDE REPLACEMENT
NOTCHED - BLANK - PAIR

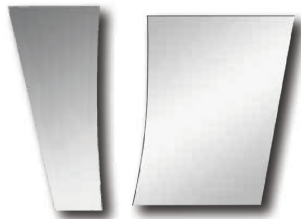

VP110311

PB 389 - HOOD EXTENSION
PANEL - WIDE REPLACEMENT
- BLANK - W/DEF - PAIR

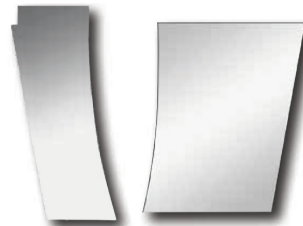

VP110312

PB 389 - HOOD EXTENSION PANEL
- WIDE REPLACEMENT NOTCHED -
BLANK - W/DEF - PAIR

HOOD EXTENSION PANELS 6"

MOUNTING HARDWARE INCLUDED



VP110364

PB 389 - HOOD EXTENSION
PANEL - FACTORY
REPLACEMENT - PAIR

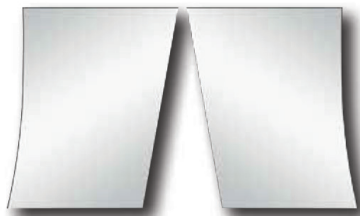

VP110366

PB 389 - HOOD EXTENSION
PANEL - WIDE REPLACEMENT
- BLANK - PAIR



VP110367

PB 389 - HOOD EXTENSION
PANEL - WIDE REPLACEMENT
NOTCHED - BLANK - PAIR

STAINLESS ACCESSORIES

PETERBILT MODEL 388 & 389

HOOD EXTENSION PANELS 4"

MOUNTING HARDWARE INCLUDED

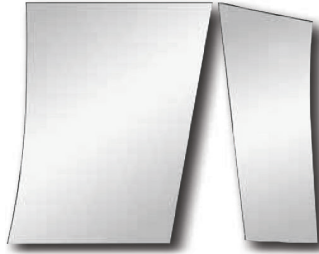

VP110307

PB 389 - HOOD EXTENSION
PANEL - WIDE REPLACEMENT
- BLANK - W/PICKETT
EXHAUST ELBOWS - PAIR

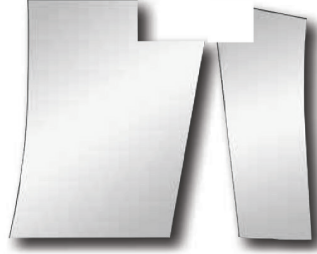

VP110397

PB 389 - HOOD EXTENSION
PANEL - WIDE REPLACEMENT
- NOTCHED- BLANK - W/
PICKETT EXHAUST ELBOWS - PAIR

HOOD EXTENSION PANELS 6"

MOUNTING HARDWARE INCLUDED

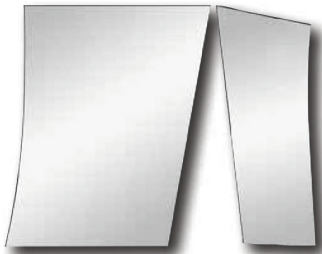

VP110379

PB 389 - HOOD EXTENSION
PANEL - WIDE REPLACEMENT
- BLANK - W/PICKETT
EXHAUST ELBOWS - PAIR

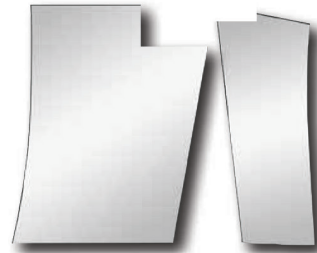

VP110398

PB 389 - HOOD EXTENSION
PANEL - WIDE REPLACEMENT
- NOTCHED- BLANK - W/
PICKETT EXHAUST ELBOWS - PAIR

ADD LIGHT OPTIONS

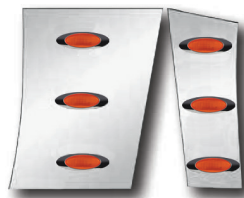

EXAMPLE
VP110307-3GA

ADD LIGHTS TO YOUR PANEL - SEE PAGES 106-107

STAINLESS ACCESSORIES

PETERBILT MODEL 388 & 389

388 CAB PANEL DEF SYSTEM

MOUNTING HARDWARE INCLUDED

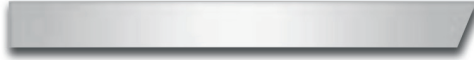

VP110229

2012 AND NEWER 388 W/DEF
WITH VERTICAL EXHAUST
PASSENGER SIDE 35", DRIVER SIDE 40"

ADD LIGHTS TO YOUR PANEL - SEE PAGES 106-107

PETERBILT MODEL 388 & 389

DEF BOX LOWERING KIT

(VP150123)



STAINLESS ACCESSORIES

PETERBILT MODEL 388 & 389

SLEEPER EXTENSION PANELS 4"

MOUNTING HARDWARE INCLUDED

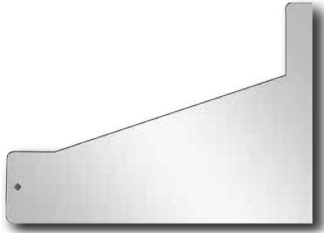

VP142101

PB SLEEPER EXTENSION
PANEL - 1987 & NEWER - 379,
388, 389 - 63"/72" - BLANK

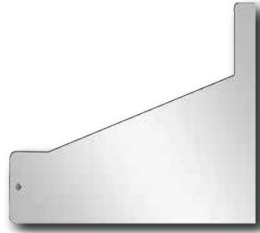

VP142103

PB SLEEPER EXTENSION
PANEL - 1987 & NEWER - 379,
388, 389 - 70"/78" - BLANK



SLEEPER EXTENSION PANELS 6"

MOUNTING HARDWARE INCLUDED

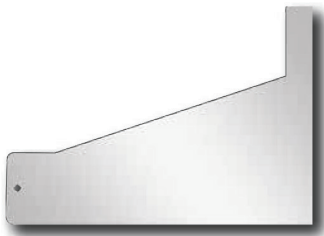

VP142150

PB SLEEPER EXTENSION
PANEL - 1987 & NEWER - 379,
388, 389 - 63"/72" - BLANK

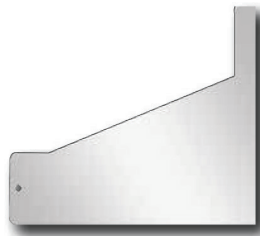

VP142151

PB SLEEPER EXTENSION
PANEL - 1987 & NEWER - 379,
388, 389 - 70"/78" - BLANK



ADD LIGHTS TO YOUR PANEL -
SEE PAGES 106-107

Peterbilt Truck Models	Original Sleeper Length Designation	New Sleeper Length Designation
365, 367, 379, 384, 386, 388, 389	36"	44"
	48"	58"
	63"	72"
	70"	78"

EXAMPLE
VP142101-1GA



STAINLESS ACCESSORIES

PETERBILT MODEL 388 & 389

AIR CLEANER LIGHT BOXES DONALDSON

CONNECT TO AIR CLEANER STRAPS:



VP112109

PB - AIR CLEANER LIGHTS - BLANK
- 388, 389 - 2007 & NEWER - PR -
DONALDSON/PREMIUM - FRONT



VP113109

PB - AIR CLEANER LIGHTS - BLANK -
REAR - 388, 389 - 2007 & NEWER - PR -
DONALDSON/PREMIUM - REAR

FOR STRAPLESS LOOK:



VP112209

PB - AIR CLEANER SUPPORT - BLANK -
379, 388, 389 - 2007 & NEWER - PAIR

ADD LIGHTS TO YOUR PANEL - SEE PAGES 106-107



VP112109-6RA shown



VP112108

PB - BLANK REAR AIR CLEANER BRACKET
388, 389 - 2007 & NEWER - PAIR -
DONALDSON/PREMIUM



VP113122

379/389 - 22"
REAR AIR CLEANER LIGHT BAR



VP112122

379/389 - 22"
FRONT AIR CLEANER LIGHT
BAR (SAME LOOK AS ABOVE
PART)



VP112129

PETERBILT 388/389 (2007-NEWER)
BLANK AIR CLEANER LIGHT BAR

Don't Forget the
Light Harness:



VHMS3007

1 - PACCAR - FEMALE 2 - PACCAR - MALE
- FOR CONNECTING FRONT & REAR AIR
CLEANER LIGHTS

VP112109-7RA

PB - AIR CLEANER LIGHTS - 8 ROUND
AMBERS - 388, 389 - 2007 & NEWER - PAIR -
DONALDSON/PREMIUM

STAINLESS ACCESSORIES

PETERBILT MODEL 388 & 389

MIRROR LIGHT BOXES



VP114011
MIRROR LIGHT BOXES - 379,
388, 389 - CAB MOUNTED
MIRRORS - BLANK



ADD - SM WITH BUILT IN SPOT MIRRORS

ADD LIGHTS TO YOUR PANEL - SEE PAGES 106-107

EXAMPLES:



VP114011-2GA
MIRROR LIGHT BOXES - 379,
388, 389 - CAB MOUNTED
MIRRORS - 2 - GRANITE -
AMBER LEDS



VP114011-5RCA
MIRROR LIGHT BOXES - 379,
388, 389 - CAB MOUNTED
MIRRORS - 5 - 2" ROUNDS -
CLEAR AMBER LEDS



VP114011-2SCA
MIRROR LIGHT BOXES - 379,
388, 389 - CAB MOUNTED
MIRRORS - 2 - SLOTTED -
CLEAR AMBER LEDS



VP114011-5RA
MIRROR LIGHT BOXES - 379,
388, 389 - CAB MOUNTED
MIRRORS - 5 - 2" ROUNDS -
AMBER LEDS

STAINLESS ACCESSORIES

PETERBILT MODEL 388 & 389

BUMPER & GRILLE TRIM



VP120000

PB TAG HANGER
(388, 389)

INCLUDES HARDWARE, FOAM
PROTECTORS AND PLASTIC
LICENSE PLATE BOLT INSERTS

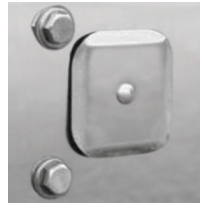

VK120003

TOW PIN COVER FITS 389



VP120012

PB SIDE GRILL

DEFLECTOR 379, 388, 389

SEE PAGE 95 FOR MORE TAG HANGERS

FENDER GUARDS



VP120013

PB FENDER GUARDS -
HEAD LIGHT MOUNT - 388,
389 - 2007 & NEWER



VP120014

PB FENDER GUARDS - PB -
HEAD LIGHT MOUNT
- 389 - W/BLINKER BAR - PR

BUG SHIELDS



VP120110

PB BUG SHIELD - STAINLESS
- 367, 388, 389

MOUNTING HARDWARE INCLUDED



STAINLESS ACCESSORIES

PETERBILT MODEL 388 & 389

EMBLEMS



VP100032
PB 389 EMBLEM ACCENT -
RACING STRIPE -
LONG HOOD
INCLUDES MOUNTING HARDWARE



VP100033
PB 389 EMBLEM ACCENT -
RACING STRIPE
- SHORT HOOD
TAPE MOUNT



VP100040
PB 389 HOOD LATCH
GUARD - PAIR
INCLUDES MOUNTING
HARDWARE

FENDER TRIM



VP100123
PB 389 FENDER
TRIM - INNER WELL - 2PC
TAPE MOUNT



VP100122
PB389 FENDER TRIM - 2PC
TAPE MOUNT

HOOD TRIM

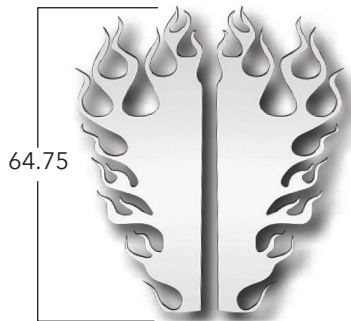

64.75

VP100124
PB 389 CENTER HOOD TRIM
2PC FLAME



VP100121
PB CENTER HOOD TRIM - 389
SCREW ON



64.75

VP100125
PB 389 CENTER HOOD TRIM
3PC FLAME (VP100121,
VP100124)

STAINLESS ACCESSORIES

PETERBILT MODEL 388 & 389 BLINKER BARS

RUBBER TRIM AND MOUNTING HARDWARE INCLUDED



VP120502

PB 389 FRONT BLINKER BARS
- W/LEDS - PAIR
NOTE: ALREADY HAS SLOTTED
LIGHT HOLES AND LIGHTS, NO
NEED TO BUILD AS CUSTOM



VP100502

PB 389 REAR BLINKER BARS -
- W/LEDS - PAIR
NOTE: ALREADY HAS SLOTTED
LIGHT HOLES AND LIGHTS, NO
NEED TO BUILD AS CUSTOM



VP120506M

PB 389 FRONT BLINKER BARS
- W/LEDS - PAIR
NOTE: ALREADY HAS SLOTTED
LIGHT HOLES AND LIGHTS, NO
NEED TO BUILD AS CUSTOM

FENDER SUPPORT COVERS

RUBBER TRIM AND MOUNTING HARDWARE INCLUDED



VP120503

PB 389 FENDER SUPPORT
COVER - FRONT
TOO NARROW FOR LIGHT OPTIONS



VP100503

PB 389 FENDER SUPPORT
COVER - REAR
TOO NARROW FOR LIGHT OPTIONS

VP120502

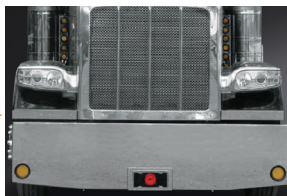

STAINLESS ACCESSORIES

PETERBILT MODEL 388 & 389

STAINLESS VISORS

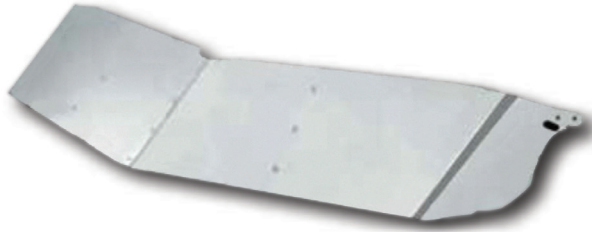

VP130013

PB - 389 14" - DROP VISOR - 2007 - NEWER
STANDARD W/ CAB MTD. MIRRORS CURVED
WINDOW, ONE PIECE WINDSHIELD
ALSO FITS MODEL 348

**PAINTABLE
VISORS
AVAILABLE**

JUST ADD "P" TO THE END
FOR PAINTABLE. EXAMPLE:

VP130013-P
RAW 18 GAUGE STEEL

ADD LIGHTS TO YOUR VISOR -
SEE PAGES 106-107 FOR LIGHT OPTIONS

FOR MORE PETE VISORS SEE PAGES 198-201

SLEEPER FILLER PANELS

MOUNTING HARDWARE INCLUDED



VP140021

PB SLEEPER REAR CORNER
FILLER PANELS 70" ONLY -
379, 389 - 4 - 4" LEDS - PAIR

STAINLESS ACCESSORIES

PETERBILT MODEL 388 & 389

MISC. TRIM PIECES



VP101001
PB 389 LOWER HOOD PANEL -
2007 & NEWER - PAIR



VP100038
PB - 389 FRONT FLAP
WEIGHTS - 11GA - PAIR



VP110018
PB WINDSHIELD TRIM - 5 PC
379, 389 - LARGE



VPTFI8022
PB OUTER FENDER
TRIM - 389
DOES NOT FIT 388
SOLD AS A SET OF 3 PAIR

VPTFI8022S
FOR ONE PAIR



VP110017
PB 388/389 TOP OF DOOR TRIM - LOWERED LOOK - PAIR
WILL ONLY FIT DOORS WITHOUT VENT WINDOW

VP110017P



ADD -P FOR PAINTABLE

STAINLESS ACCESSORIES

PETERBILT MODEL 388 & 389

MISC. TRIM PIECES



VP110020
PB - OUTSIDE DOOR TRIM -
389 - 2-PCS
TAPE MOUNT



VP110025
PB 379, 388, 389 WINDSHIELD WIPER
ARM COVERS
TAPE MOUNT



VP110019
PB 389 OUTSIDE DOOR TRIM -
CORNER ANGLE - PAIR
TAPE MOUNT



VP110090
PB EXHAUST SHIELDS -
388, 389 - W/NO LOGO
BRACKETS & HARDWARE INCLUDED

STAINLESS ACCESSORIES

PETERBILT MODEL 388 & 389

SLEEPER SHOCK COVERS



VP140034
PB SLEEPER SHOCK COVERS
- 379, 389 - 2 PCS (L+R)
ANGLED
TAPE MOUNT



VP140022
PB 379, 389 SLEEPER SHOCK
COVERS - 2 PAIR
TAPE MOUNT

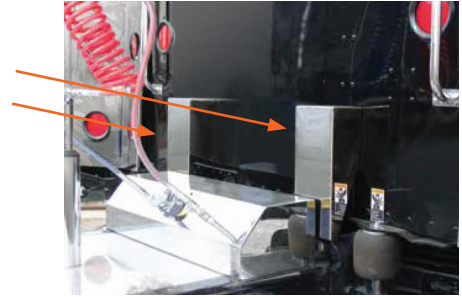

VP140032
PB SLEEPER SHOCK COVERS
- 379,389 - 1 LG FULL COVER
TAPE MOUNT

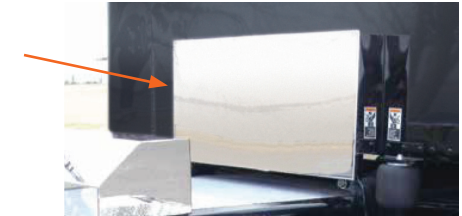

VP140035
PB SLEEPER SHOCK COVER -
379,389 ANGLED FULL COVER



VP140033
PB SLEEPER SHOCK COVERS
- 379,389 - 1 LG CURVED FULL COVER

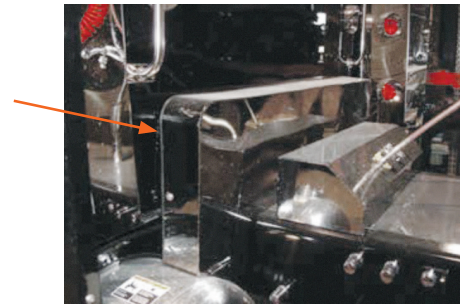

RUBBER STRIP & HARDWARE INCLUDED

AIR DEFLECTORS



VP110016
PB 359 - 379, 389 WINDOW
AIR DEFLECTORS
TAPE MOUNT



VP110031
PB 359 - 379, 389 WINDOW
AIR DEFLECTORS W/LOWER
LOOKS(VP110017)WINDOW
TRIM 37.25" X 20.375"
TAPE MOUNT

STAINLESS ACCESSORIES

PETERBILT MODEL 388 & 389

FUEL TANK STRAP COVERS

BRACKETS & MOUNTING HARDWARE INCLUDED



VP150020
PB - FUEL TANK STRAP
COVERS - 4PCS



VP150029
PB - FUEL TANK STRAP
COVERS - 2PCS
NOT 359

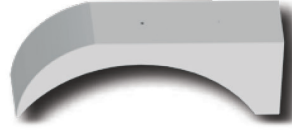

VP150029R
PB - FUEL TANK STRAP
COVERS - ROUND - 2PCS
ALL BUT 359



EXHAUST COVERS



VP150021
PB - 389 EXHAUST COVER -
PASSENGER SIDE - FITS 06
FITS 06 - JULY 07



VP150022
PB - 389 EXHAUST COVER -
DRIVERS SIDE - FITS 06 - JULY
FITS 06 - JULY 07



VP150023
PB - 388, 389 EXHAUST COVER
- PASSENGER & DRIVERS SIDE
FITS 06 - JULY 07



STAINLESS ACCESSORIES

PETERBILT MODEL 388 & 389

TOOL & BATTERY BOX COVERS

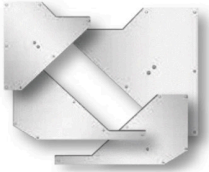

VP150000
PB BATTERY BOX STAINLESS
COVER KIT - 389 - 2013-OLDER
- 4 PCS

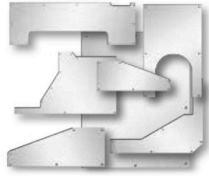

VP150009
PB TOOL BOX STAINLESS
COVER KIT - 389 - 2013-OLDER
- CATALYTIC COVER PASS
SIDE - 7 PCS



VP150005
PB TOOL BOX COVER - 389



VP150006
PB BATTERY BOX COVER - 389
WITH 1" LIP



VP150007
PB TOOL & BATTERY BOX
COVERS - 389 WITH 1" LIP - 2 PCS



VP150008
PB TOOL & BATTERY BOX
STEP TRIMS - 389 - 4 PCS



VP150014
PB 389 TOOL BOX FILLER
BLOCK FOR BOTTOM STEP



VP150018
PB 389 BATTERY BOX COVER
MOLDED - 3PCS



VP150019
PB 389 BATTERY BOX LOWER
STEP COVER W/SIDES - 3PCS

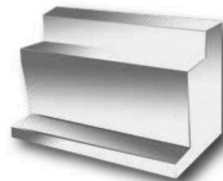

VP150024
PB - 389 UREA CATALYTIC
COVER 3PC COVER - '12 AND
OLDER

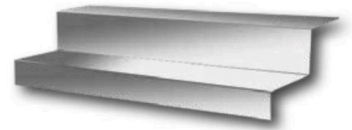

VP150025
PB - 389 UREA CATALYTIC
COVER HIGHLIGHT - UPPER -
'12 AND OLDER

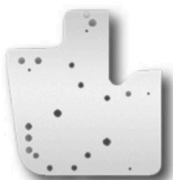

VP150042
PB - 389 - 2014 UREA
CATALYTIC COVER HIGHLIGHT
- SIDES - 2PCS



VP150027
PB - 389 - 2013-OLDER UREA
CATALYTIC COVER HIGHLIGHT
- SIDES - 2PCS



VP150026
PB - 389 UREA CATALYTIC
COVER HIGHLIGHT - LOWER

ADD "P" FOR PAINTABLE

STAINLESS ACCESSORIES

PETERBILT MODEL 388 & 389

BATTERY BOXES & TOOL BOXES

STANDARD WIDTH 30" / CUSTOM WIDTHS AVAILABLE UP TO 48"

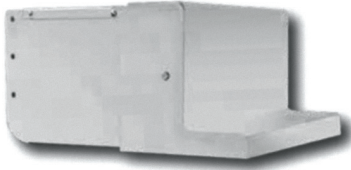

VP150112 - PB - 379,388, 389 REAR TOOL BOX - STAINLESS W/LOCKS - MOULDED LID
VP150113 - PB - 379, 388, 389 BATTERY BOX - STAINLESS W/LOCKS - MOULDED LID

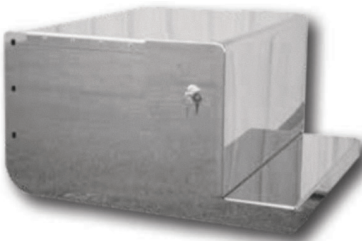

VP150109R - PB - 379, 388, 389 REAR TOOL BOX - STAINLESS W/LOCKS - ROUNDED SMOOTH LOOK
VP150110R - PB - 379, 388, 389 BATTERY BOX - STAINLESS W/LOCKS - ROUNDED SMOOTH LOOK

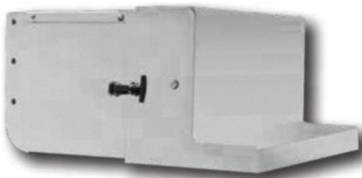

VP150115 - PB - 379,388, 389 REAR TOOL BOX - STAINLESS W/LOCKS - MOULDED LID
VP150116 - PB - 379, 388, 389 BATTERY BOX - STAINLESS W/LOCKS - MOULDED LID
VP150116TM - PB - 379, 388, 389 BATT, BOX - STAINLESS W/TIE DOWNS - 18" TALL MOLDED LID

ADD -36 TO ANY STAINLESS TOOL BOX PART NUMBER FOR A 36" BOX
ADD -48 TO ANY STAINLESS TOOL BOX PART NUMBER FOR A 48" BOX

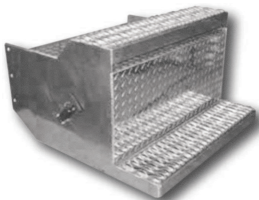

VP150103
PB - 379, 388, 389 BATTERY
BOX - ALUMINUM



VP150104
PB - 379, 388, 389 BATTERY
BOX - ALUMINUM



BOX STEP HIGHLIGHTS/PROTECTORS



VP150030
PB TOOL BOX/BATTERY BOX - STEP
PROTECTOR-(18") - WICKED PR

VP150031
PB TOOL BOX/BATTERY BOX
- STEP PROTECTOR- (30")
WICKED PAIR

PAINTED OPTIONS SHOWN



STAINLESS ACCESSORIES

PETERBILT MODEL 567



Bumpers and Stainless Accessories made in the USA



www.valleychrome.com

STAINLESS ACCESSORIES

PETERBILT MODEL 567

CAB PANEL

MOUNTING HARDWARE INCLUDED

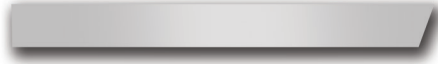

VP110277

PB CAB PANELS - 567 - BLANK

SLEEPER PANELS

MOUNTING HARDWARE INCLUDED



VP140283

PB SLEEPER PANELS -
567 - 80" - BLANK W/REAR
EXHAUST



VP142079

PB SLEEPER PANELS - 567 & 579 - 80" -
EXHAUST BEHIND SLEEPER

Peterbilt Truck Models	Original Sleeper Length Designation	New Sleeper Length Designation
567, 579	36"	44"
	63"	72"
	(N/A)	80"

HOOD EXTENSION PANELS

FENDER GUARDS



VP110401

PB 567 - HOOD EXTENSION
PANEL - FILLER PANEL



VP110402

PB 567 - HOOD EXTENSION
PANEL - FACTORY LAYOVER
TAPE MOUNT



VP110403

PB 567 - HOOD
EXTENSION PANEL - WIDE
REPLACEMENT - BLANK - PAIR



VP120019

PB FENDER GUARD - 567
FITTED 4PCS. UPPER &
LOWER

STAINLESS ACCESSORIES

PETERBILT MODEL 567

BUG SHIELDS



VP120114

PB BUG SHIELD - STAINLESS
567, 579

MOUNTING HARDWARE INCLUDED

FUEL TANK STRAP COVERS

BRACKETS & MOUNTING HARDWARE INCLUDED



VP150048

PB - 567 FUEL TANK STRAP
COVERS - 4PCS



STAINLESS ACCESSORIES

PETERBILT MODEL 567

STAINLESS VISORS

VP130007

PB - 12" - DROP VISOR 2013 579 DAY CAB
ALSO FITS MODEL 567

**PAINTABLE
VISORS
AVAILABLE**

JUST ADD "P" TO THE END
FOR PAINTABLE. EXAMPLE:

VP130007P
RAW 18 GAUGE STEEL



PAINTABLE CUSTOM VISOR SHOWN
VP130007P-16-10BYA

ADD LIGHTS TO YOUR VISOR - SEE PAGES 106-107

FOR MORE PETE VISORS SEE PAGES 198-201

VC VALLEY
CHROME
PLATING

STAINLESS ACCESSORIES

PETERBILT MODEL 579



Bumpers and Stainless Accessories made in the USA



www.valleychrome.com

STAINLESS ACCESSORIES

PETERBILT MODEL 579

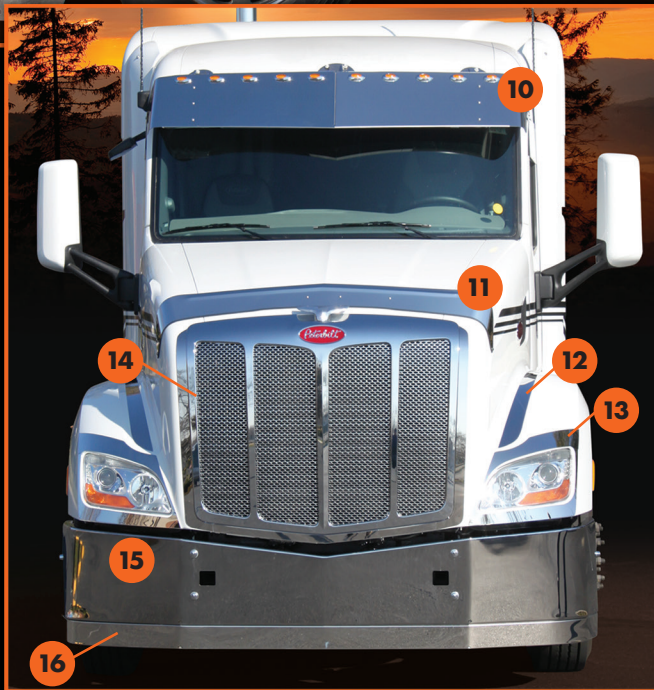

- 1 VP110028** Top of door trim - "lowered" look
- 2 VP140029** Sleeper door handle outer trim with fire extinguisher cutout
- 3 VP142077** Sleeper panels - driver & pass. sides (shown with optional light cutouts)
- 4 VP150112-21** Tool box 21"
- 5 VP150032** Fuel tank fairing upper highlight trim
- 6 VP150034** Kick panel trim
- 7 VP110271** Cab panel with heater plug cutout (shown with optional light cutouts)
- 8 VP110029** Lower door highlight trim
- 9 VP100127** Fender highlight trim (4 pcs driver & passenger sides)
- 10 VP130008** Visor (VP130008-10GMA shown)
- 11 VP120114** Bug shield
- 12 VP100126** Fender highlight, 2 pcs (inner well)
- 13 VP120018** Fender guards
- 14 VP100034** Front hood bug guards (3 pcs.)
- 15 HZ-0010-16Y** Front bumper (other options available)
- 16 HZ-SP** Front bumper air dam

STAINLESS ACCESSORIES

PETERBILT MODEL 579

CAB PANELS

MOUNTING HARDWARE INCLUDED
ULTRA AND ULTRA LOFT CABS USE SAME PANELS



VP110270
PB CAB PANELS - 579 - BLANK - 2 PCS



VP110271
PB CAB PANELS - 579 - BLANK
W/HEATER PLUG HOLE - 2 PCS



VP110276
PB CAB PANELS - 579 - BLANK -
SHORT HOOD - 2016



VP110272
PB CAB PANELS - 579 DAY
CAB OR VERT EXHAUST
BLANK - 2 PCS



VP110273
PB CAB PANELS - 579 DAY CAB OR
VERT EXHAUST- BLANK W/HEATER
PLUG HOLE - 2 PCS

SLEEPER PANELS

MOUNTING HARDWARE INCLUDED



VP142075
PB SLEEPER PANELS - 579
- 36"/44" - EXHAUST BEHIND
SLEEPER



VP142077
PB SLEEPER PANELS - 579 -
63"/72" - BLANK



VP142078
PB SLEEPER PANELS - 579
- 80" - BLANK W/FRONT
EXHAUST



VP142079
PB SLEEPER PANELS - 579 - 80" -
EXHAUST BEHIND SLEEPER

Peterbilt Truck Models	Original Sleeper Length Designation	New Sleeper Length Designation
567, 579	36"	44"
	63"	72"
	(N/A)	80"

ADD LIGHTS TO YOUR PANEL - SEE PAGES 106-107

VP110271-4GMA



STAINLESS ACCESSORIES

PETERBILT MODEL 579

DEF SYSTEM PANELS

BRACKETS & MOUNTING HARDWARE INCLUDED



VP150043
PB - 579 DEF CATALYTIC
COVER HIGHLIGHT - UPPER

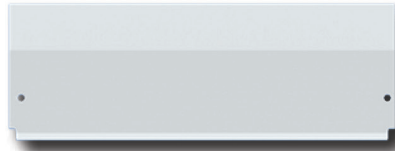

VP150044
PB - 579 DEF CATALYTIC
COVER HIGHLIGHT - LOWER



VP150045W
PB - 579 DEF CATALYTIC
LOWER STEP COVER - WING STYLE



VP150046
PB - 579 DEF CATALYTIC
EXHAUST COVER -
DYNAFLEX EXHAUST



VP150044

VP150045W



STAINLESS ACCESSORIES

PETERBILT MODEL 579

MISC. TRIM PIECES



VP100126
PB 579 FENDER
HIGHLIGHT - INNER WELL 2 PCS
TAPE MOUNT



VP100127
PB 579 FENDER
TRIM DS/PS - 4PC
TAPE MOUNT



VP100034
PB 579 FRONT HOOD GRILLE SURROUND
TAPE MOUNT



VP110028
PB 579 TOP OF DOOR TRIM -
LOWERED LOOK - PAIR
TAPE MOUNT



VP110030
PB 579 TOP OF DOOR TRIM -
LOWERED LOOK - PAIR - W/MIRROR
HOLES PASS. SIDE



STAINLESS ACCESSORIES

PETERBILT MODEL 579

MISC. TRIM PIECES



VP110029
PB - 579 LOWER DOOR
HIGHLIGHT - 2PC



VP120018
PB FENDER GUARD - 579
FITTED 4PCS. UPPER &
LOWER



VP120114
PB BUG SHIELD - STAINLESS
567,- 579
MOUNTING HARDWARE INCLUDED

STAINLESS ACCESSORIES

PETERBILT MODEL 579

STAINLESS VISORS



VP130007

PB - 12" - DROP VISOR 2013 TO 2019 579 DAY CAB ONLY
ALSO FITS MODEL 567, DOES NOT FIT ULTRA LOFT

VP130008

PB - 14" - DROP VISOR 2013 TO 2019 579 RAISED ROOF ULTRACAB
NOTE: MOUNTS TO EXISTING FACTORY VISOR BRACKETS
NO OTHER MOUNTING BRACKETS PROVIDED

**PAINTABLE
VISORS
AVAILABLE**

JUST ADD "P" TO THE END
FOR PAINTABLE. EXAMPLE:

VP130008-P

RAW 18 GAUGE STEEL



VP130008-10GMA SHOWN

ADD LIGHTS TO YOUR VISOR - SEE PAGES 106-107



VP132008

PB - 18" GANGSTER VISOR - FITS 579
ULTRA CAB ONLY, DOES NOT FIT ULTRA LOFT



VP132008-BF

PB - 18" GANGSTER VISOR -
BUTTERFLY - FITS 579
ULTRA CAB ONLY, DOES NOT FIT ULTRA LOFT



VP130014

PB - 16" STD MOUNT DROP VISOR
579 ULTRA LOFT ONLY

FOR MORE PETE VISORS SEE PAGES 198-201

STAINLESS ACCESSORIES

PETERBILT MODEL 579

SLEEPER SHOCK COVERS

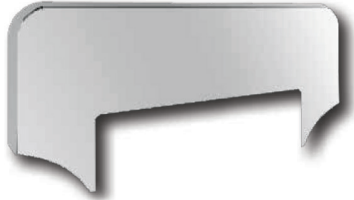

VP140037
PB SLEEPER SHOCK/
BREATHER COVER - 579 FULL COVER
RUBBER STRIP & MOUNTING
HARDWARE INCLUDED



VP140036
PB SLEEPER BREATHER
COVERS - 579 - 2 PCS ANGLED
TAPE MOUNT

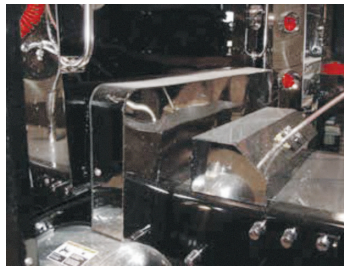

VP140038
PB SLEEPER SHOCK COVER -
579 FULL COVER
RUBBER STRIP & MOUNTING
HARDWARE INCLUDED

TANK FAIRING HIGHLIGHT



VP150032
PB - 579 FUEL TANK FAIRING
UPPER HIGHLIGHT - 2PCS
TAPE MOUNT



KICK PANEL TRIM



VP150034
PB - 579 DOOR ENTRY KICK
PANELS - 2PCS

STAINLESS ACCESSORIES

PETERBILT MODEL 587

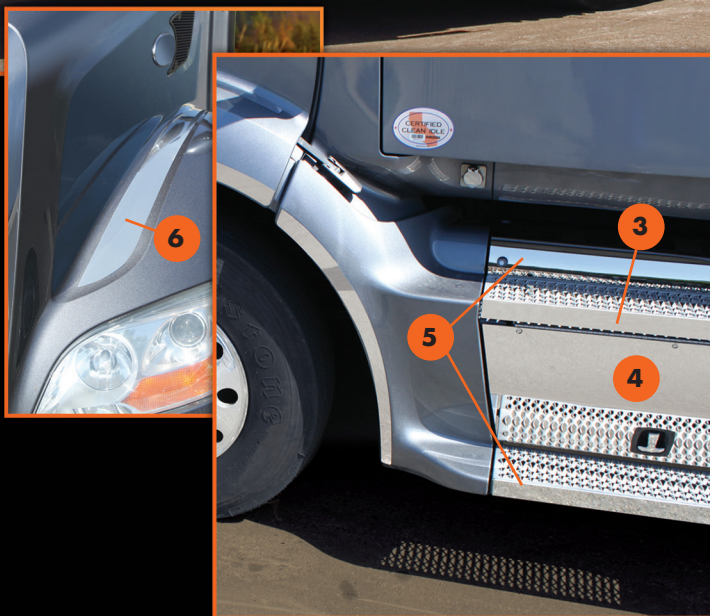

- 1 VP13011** Drop visor, 16", for raised roof
- 2 VP100129** Outer fender trim kit
(4 pieces - driver & pass. sides)
- 3 VP150036** Door entry kick panels
(2 pieces - driver & pass. sides)
- 4 VP150037** Tool box / battery box cover
(One pair - driver & pass. sides)
- 5 VP150038** Step highlights, upper & lower
(4 pieces - driver & pass. sides)
- 6 VP100128** Fender inner highlight
(2 pieces - driver & pass. sides)
- 7 HOA-0010-16** Chrome bumper, 16" wide
(other options available)
- 8 HOA-SP** Stainless air dam for bumper

STAINLESS ACCESSORIES

PETERBILT MODEL 587

FENDER TRIM



VP100128
PB 587 FENDER
HIGHLIGHT DS/PS - 2PC



VP100129
PB 587 FENDER
TRIM DS/PS - 4PC



STAINLESS VISORS

**PAINTABLE
VISORS
AVAILABLE**

JUST ADD "P" TO THE END
FOR PAINTABLE. EXAMPLE:

VP130011P
RAW 18 GAUGE STEEL

VP130011

PB - 587 16" DROP VISOR - 2011 AND NEWER RAISED ROOF



ADD LIGHTS TO YOUR VISOR - SEE PAGES 106-107

STAINLESS ACCESSORIES

PETERBILT MODEL 587

MISC. TRIM PIECES



VP150036

PB - 587 DOOR ENTRY KICK
PANELS - 2PCS



VP150037

PB - 587 TOOL/BATTERY BOX
COVER - 2 PCS



VP150038

PB - 587 0 STEP HIGHLIGHTS
- 4 PCS



STAINLESS ACCESSORIES

PETERBILT MODEL 589



1. **VP130017** - 12" DROP VISOR (MOUNTS TO FACTORY BRACKETS)

2. **VP112120** - **7GSCA** FRONT AIRCLEANER LITE BAR W/7 GRANITE SLIM CLEAR AMBERS

3. **VP110420** - **4GSCA** HOOD EXTENSION W/4 GRANITE SLIM CLEAR AMBERS

4. **VP110221** - **3GSCA** DRIVER-SIDE CAB PANEL W/3 GRANITE SLIM CLEAR AMBERS

5. **VP113120** - **7GSCR** REAR AIRCLEANER LITE BAR W/7 GRANITE SLIM CLEAR REDS

6. **VP142045** - **5GSCA** 63" SLEEPER PANEL W/5 GRANITE SLIM CLEAR AMBERS

STAINLESS ACCESSORIES

PETERBILT MODEL 589

FENDER GUARDS, AIR CLEANER LIGHT BARS, CAB & SLEEPER PANELS

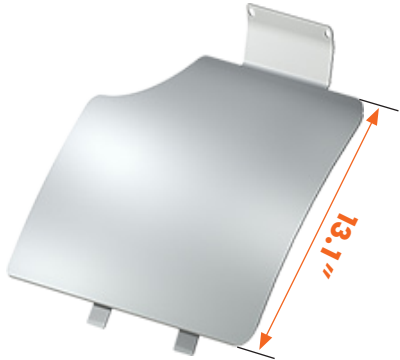

VP120020

PB BLIND MOUNT FENDER GUARD

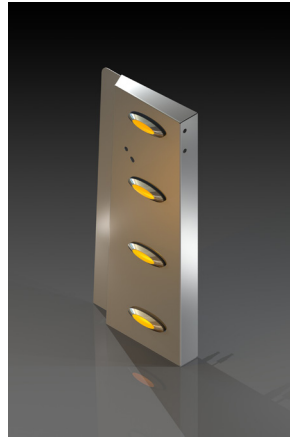

VP110420-4GSCA

PB HOOD EXTENSION

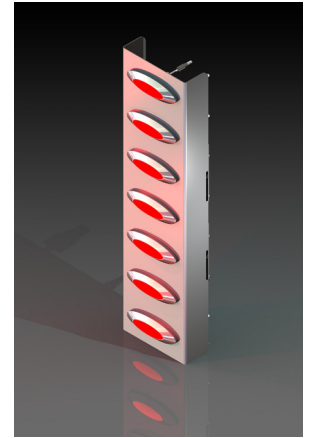

VP113120-7GSCR

PB REAR AIRCLEANER LITE BAR

W/4 GRANITE SLIM CLEAR AMBERS W/7 GRANITE SLIM CLEAR REDS

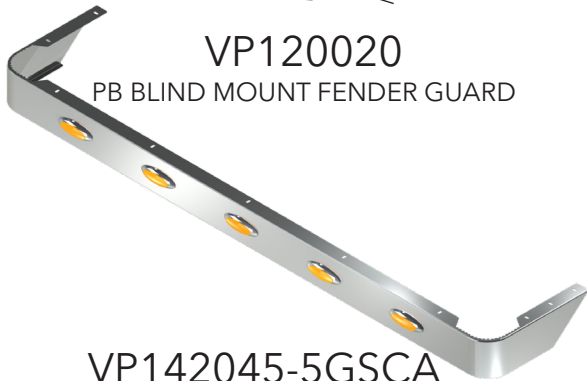

VP142045-5GSCA

PB 63" SLEEPER PANEL
W/5 GRANITE SLIM CLEAR AMBERS



VP112121

PB FRONT AIRCLEANER LITE BAR
(NO CUTOUTS)



VP112120-7GSCA

PB REAR AIRCLEANER LITE BAR
W/7 GRANITE SLIM CLEAR AMBERS



VP110221-3GSCA

PB DRIVER-SIDE CAB PANEL
W/3 GRANITE SLIM CLEAR AMBERS

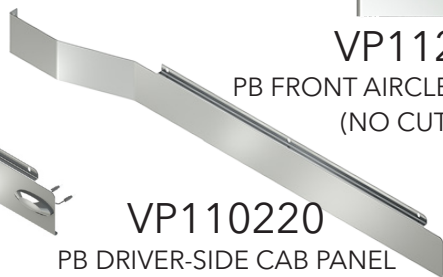

VP110220

PB DRIVER-SIDE CAB PANEL
(NO CUTOUTS)



VP150054

PB FUEL TANK WRAP

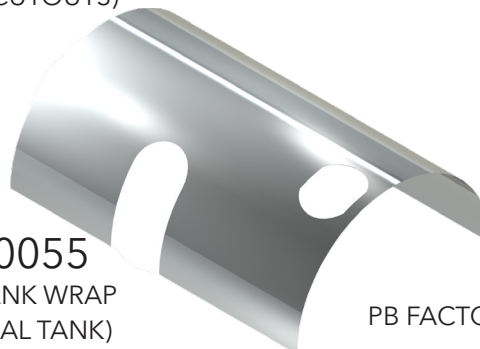

VP150055

PB FUEL TANK WRAP
(FITS 100GAL TANK)

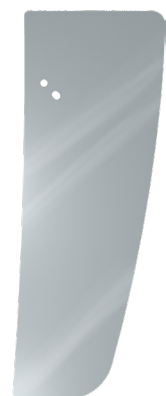

VP110421

PB FACTORY HOOD PANEL REPLACEMENT

STAINLESS ACCESSORIES

PETERBILT MODEL 589 YEARS 2024 & NEWER VISORS



VP133017
12" WICKED VISOR
(FITS TRUCKS W/FACTORY VISOR)



VP135017
12" WICKED VISOR
(FITS TRUCKS W/FACTORY VISOR)

PETERBILT

WATERMELON LIGHT BRACKETS & PLATES

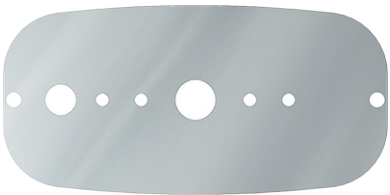

VP170108
SINGLE WATERMELON INTERIOR
PLATE W/SWITCH HOLE
(389 CENTER DOME LIGHT)

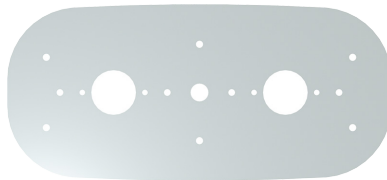

VP170106
DUAL WATERMELON INTERIOR PLATE
W/SWITCH HOLE
(389 DOME LIGHT)

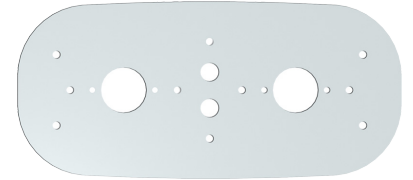

VP170107
DUAL WATERMELON INTERIOR PLATE
W/2 SWITCH HOLE
(389 DOME LIGHT)

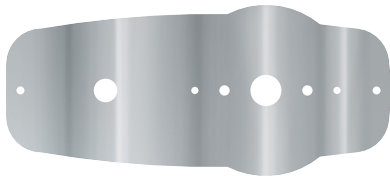

VP170110
SINGLE WATERMELON INTERIOR PLATE
W/SWITCH HOLE



VP170111
3 WATERMELON BRACKET (ULTRA BUNK)
CUTOUTS ONLY



VU-1110L-A
AMBER WATERMELON
LIGHT
(EXPLODED VIEW)
(SOLD SEPARATELY)

STAINLESS ACCESSORIES

ACCESSORIES FOR ALL PETERBILT MODELS



STAINLESS ACCESSORIES

ALL PETERBILT MODELS

HOOD EMBLEMS

PETERBILT LOGO EMBLEM NOT INCLUDED



VP100004
EMBLEM ACCENT PB
TEAR DROP - 2PC
TAPE MOUNT



VP100005
EMBLEM ACCENT PB
TEAR DROP W/CUTOUPS - 2PC
TAPE MOUNT



VP100006
EMBLEM ACCENT PB
ELLIPSE W/CUTOUP - PAIR
INCLUDES MOUNTING HARDWARE



VP100007
EMBLEM ACCENT PB
SKULL & CROSSBONES - PAIR
TAPE MOUNT



VP100008
EMBLEM ACCENT PB
CHECKERED FLAG - PAIR
INCLUDES MOUNTING HARDWARE



VP100010
EMBLEM ACCENT PB
WILD FIRE - PAIR
TAPE MOUNT



VP100011
EMBLEM ACCENT PB
FLAMES - 2PC
INCLUDES MOUNTING HARDWARE



VP100013
EMBLEM ACCENT PB
OVAL - PAIR
TAPE MOUNT



VP100012
EMBLEM ACCENT PB
CHEVRON - PAIR
TAPE MOUNT

STAINLESS ACCESSORIES

ALL PETERBILT MODELS

HOOD EMBLEMS

PETERBILT LOGO EMBLEM NOT INCLUDED



VP100014
EMBLEM ACCENT PB
OVAL - W/CUTOUTS - PAIR
INCLUDES MOUNTING
HARDWARE



VP100015
EMBLEM ACCENT PB
OVAL - W/SPADES - PAIR
TAPE MOUNT



VP100016
EMBLEM ACCENT PB
OVAL - W/2-EXTENSIONS - PAIR
TAPE MOUNT



VP100017
EMBLEM ACCENT PB
OVAL - W/3-EXTENSIONS - PAIR
TAPE MOUNT



VP100018
EMBLEM ACCENT PB
SWIRL - 2PC
INCLUDES MOUNTING
HARDWARE



VP100027
EMBLEM ACCENT PB -
FISH - PAIR
INCLUDES MOUNTING
HARDWARE



VP100029
EMBLEM ACCENT PB -
FLAMES - 2PCS.
INCLUDES MOUNTING
HARDWARE



VP100019
EMBLEM ACCENT PB
SWIRL - W/CUTOUTS - 2PC
INCLUDES MOUNTING
HARDWARE

HOOD LATCH GUARDS



VP100022
PB HOOD LATCH TRIM
STANDARD HOOD - 2PC



VP100024
PB HOOD LATCH TRIM
EXTENDED HOOD - 2 PC



VU190011
PB, FL, KW, HOOD LATCH
ACCENT TRIM - PAIR

STAINLESS ACCESSORIES

ALL PETERBILT MODELS

KEY GUARDS

STRONG 3M DOUBLE-SIDED TAPE INCLUDED



VP110001
PB KEY GUARD
FLAME - PAIR



VP110002
PB KEY GUARD
TEAR DROP - PAIR



VP110003
PB KEY GUARD
CHECKERED FLAG - PAIR



VP110004
PB KEY GUARD
TRIANGLE - PAIR



VP110005
PB KEY GUARD
OVAL - PAIR



VP110006
PB KEY GUARD
ELLIPSE W/CUTOUT - PAIR



VP110007
PB KEY GUARD
WILDFIRE - PAIR



VP110008
PB KEY GUARD - FISH

MISC. TRIM PIECES

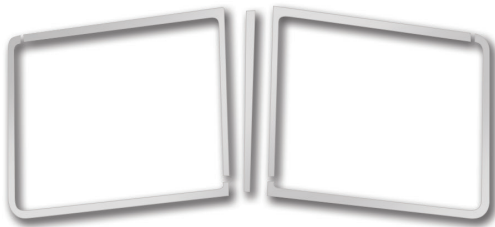

VP110014
PB WINDSHIELD TRIM 3 PC



VP110021
PB WINDSHIELD TRIM 5 PC

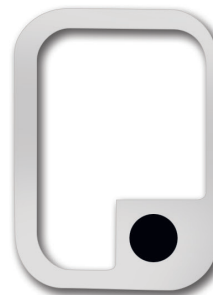

VP110011
PB CAB MOUNTED MIRRORS
DOOR LATCH/KEY HOLE
COVERS - 2PC

STAINLESS ACCESSORIES

ALL PETERBILT MODELS

BUG SHIELD - MODEL 387



VP120108
PB BUG SHIELD - STAINLESS
PETE - 387
MOUNTING HARDWARE INCLUDED

WINDOW TRIM

MOUNTS WITH STRONG 3M DOUBLE-SIDED TAPE



VP140001
PB RECTANGULAR
VIEW WINDOW
TRIM RING



VP140002
PB 70" SLEEPER
WINDOW TRIM - PAIR



VP140003
PB SLEEPER/DAY CAB REAR
WINDOW TRIM 37.25" X 20.375"



VP140014
PB 70" SLEEPER WINDOW TRIM
- LOWERED LOOK PR

SLEEPER WINDOW LOWER LOOKS

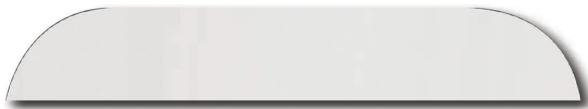

VP140117
PB TOP OF DOOR TRIM - LOWERED LOOK - PR
WILL ONLY FIT DOORS WITHOUT VENT WINDOW

ADD -P FOR PAINTABLE



STAINLESS ACCESSORIES

PETERBILT SUN VISORS BY CAB TYPE

STANDARD MOUNT STAINLESS VISORS

BRACKETS AND MOUNTING HARDWARE INCLUDED
AVAILABLE IN 304 STAINLESS STEEL - CALL FOR PRICING



VP130000
PB-14" - DROP VISOR 1996-98 ULTRA CAB



VP130001
PB - 359 12" DROP VISOR - ANY YEAR 359



VP130002
PB-14" - DROP VISOR - STANDARD CAB 2005 & OLDER WITH DOOR MOUNTED MIRRORS



VP130002-16
PB - 16" - DROP VISOR - STANDARD CAB 2005 & OLDER, NOTE 04 AND OLDER DOOR MNT MIRRORS



VP130003
PB - 14" - DROP VISOR - 1999-2001 ONLY, ULTRACAB



VP130003-16
PB-16" - DROP VISOR 1999 - 2001 ULTRACAB



VP130004
PB - 14" - DROP VISOR - 2002 - 2005 ULTRACAB WITH DOOR MOUNTED MIRRORS

VP130004-16
PB - 16" - DROP VISOR - 2002 - 2005 ULTRACAB WITH DOOR MOUNTED MIRRORS

VP130005
PB - 14" - DROP VISOR - 2005 - NEWER ULTRACAB - W/CAB MOUNTED MIRRORS

VP130005-16
PB - 16" - DROP VISOR - 2005 - NEWER ULTRACAB W/CAB MOUNTED MIRRORS

VP130006
PB - 13.5" - DROP VISOR - 2005 - NEWER STANDARD CAB W/CAB MOUNTED MIRRORS, ALSO FITS MODEL 348

VP130006-16
PB - 16" - DROP VISOR - 2005 - NEWER STANDARD W/CAB MOUNTED MIRRORS ALSO FITS MODEL 348

VP130017
PB-12"- DROP VISOR 2025-NEW



VP130005

**PAINTABLE
VISORS
AVAILABLE**

JUST ADD "P" TO THE END FOR PAINTABLE. EXAMPLE:

VP130002-P
RAW 18 GAUGE STEEL

ADD LIGHTS TO YOUR VISOR - SEE PAGES 106-107 FOR LIGHT OPTIONS

STAINLESS ACCESSORIES

PETERBILT SUN VISORS BY CAB TYPE

BOLTLESS MOUNT STAINLESS VISORS

BRACKETS AND MOUNTING HARDWARE INCLUDED
AVAILABLE IN 304 STAINLESS STEEL - CALL FOR PRICING



VP131002
PB-14" - BOLTLESS - DROP VISOR - STANDARD CAB 2005 & OLDER - DOOR MOUNTED MIRRORS - 1PC

VP131002-16
PB-16" - BOLTLESS - DROP VISOR - STANDARD CAB 2005 & OLDER - DOOR MOUNTED MIRRORS - 1PC



VP131003
PB-14" - BOLTLESS - DROP VISOR - 1999 - 2001 - ULTRACAB - 1PC

VP131003-16
PB-16" - BOLTLESS - DROP VISOR - 1999 - 2001 - ULTRACAB - 1PC



VP131004
PB - 14" - BOLTLESS - DROP VISOR - 2002 - 2005 ULTRACAB WITH DOOR MOUNTED MIRRORS - 1 PC

VP131004-16
PB - 16" - BOLTLESS - DROP VISOR - 2002 - 2005 ULTRACAB WITH DOOR MOUNTED MIRRORS - 1 PC



VP131005
PB - 14" - BOLTLESS DROP VISOR 2005 + ULTRACAB ONE PIECE W/CAB MT MIRRORS

VP131005-16
PB - 16" - DROP VISOR 2005 + ULTRACAB ONE PIECE W/CAB MT MIRRORS



VP131006
PB - 14" - BOLTLESS - DROP VISOR - 2005 - NEWER STANDARD W/CAB MOUNTED MIRRORS - 1 PC

VP131006-16
PB - 16" - BOLTLESS DROP VISOR - 2005 - NEWER STANDARD W/CAB MOUNTED MIRRORS - 1 PC



VP130005

**COOL
BOLTLESS
LOOK!**

**PAINTABLE
VISORS
AVAILABLE**

JUST ADD "P" TO THE END FOR PAINTABLE. EXAMPLE:

VP131002-P
RAW 18 GAUGE STEEL

ADD LIGHTS TO YOUR VISOR - SEE PAGES 106-107 FOR LIGHT OPTIONS

STAINLESS ACCESSORIES

PETERBILT WICKED VISORS

BOLTLESS STAINLESS VISORS

BRACKETS AND MOUNTING HARDWARE INCLUDED
AVAILABLE IN 304 STAINLESS STEEL - CALL FOR PRICING



VP135000
PB - 15" WICKED - DROP VISOR
1996-98 ULTRA CAB - 2 PC

VP135001
PB - 12" WICKED - DROP
VISOR - ANY YEAR 359 - 2PC

VP135002
PB - 15" WICKED - DROP
VISOR - STANDARD CAB
2005 & OLDER W/DOOR
MOUNTED MIRRORS - 2 PC

VP135003
PB - 15" WICKED - DROP
VISOR 1999-2001 ULTRA
CAB - 2PC

VP135004
PB - 15" WICKED - DROP
VISOR - 2002 - 2005
ULTRACAB WITH DOOR
MOUNTED MIRRORS - 2 PC



VP135005
PB - 15" WICKED - DROP
VISOR - 2005 - NEWER
ULTRACAB W/CAB MOUNTED
MIRRORS - 2 PC



VP135006
PB - 15" WICKED - DROP
VISOR - 2005 - NEWER
STANDARD W/CAB
MOUNTED MIRRORS - 2 PC



VP136002
PB - 13" WICKED
GANGSTER VISOR - FITS
ANY - 370 SERIES & 380
SERIES - 2 PC



VP135006

YOU SAY
WICKED
LIKE IT'S A BAD THING

**COOL
BOLTLESS
LOOK!**



ADD LIGHTS TO YOUR VISOR - SEE PAGES 106-107 FOR LIGHT OPTIONS

STAINLESS ACCESSORIES

PETERBILT SUN VISORS

GANGSTER STAINLESS VISORS

BRACKETS AND MOUNTING HARDWARE INCLUDED
MADE WITH 16 GAUGE GRADE 430



VP132002
PB - 12" GANGSTER VISOR - FITS ANY - 370 SERIES & 380 SERIES 2 PC WITH SPLIT WINDSHIELD



VP132002-BF
PB - 12" GANGSTER BUTTERFLY VISOR - FITS ANY 370 SERIES & 380 SERIES 2 PC WITH SPLIT WINDSHIELD



VP132002P-BF
PB - 12" GANGSTER BUTTERFLY VISOR PAINTABLE - FITS ANY 370 SERIES & 380 SERIES 2 PC WITH SPLIT WINDSHIELD



VP132002-RBF
PB - 12" GANGSTER REVERSE BUTTERFLY VISOR - FITS ANY - 370 SERIES & 380 SERIES 2 PC WITH SPLIT WINDSHIELD



VP132002P-RBF
PB - 12" GANGSTER REVERSE BUTTERFLY VISOR PAINTABLE - FITS ANY - 370 SERIES & 380 SERIES 2 PC WITH SPLIT WINDSHIELD



VP132002-BT
PB - 12" GANGSTER BOWTIE VISOR - FITS ANY 370 SERIES & 380 SERIES 2 PC WITH SPLIT WINDSHIELD



VP132002P-BT
PB - 12" GANGSTER BOWTIE VISOR PAINTABLE - FITS ANY 370 SERIES & 380 SERIES 2 PC WITH SPLIT WINDSHIELD



VP132017
PB-14" - GANGSTER REVERSE BOWTIE VISOR - FITS ULTRA CAB



VP132018
PB-14" - BOLTLESS - GANGSTER FLAT BOT-TOM VISOR - FITS ULTRA CAB



VP132002P-BT shown



**PAINTABLE
VISORS
AVAILABLE**

JUST ADD "P" TO THE END
FOR PAINTABLE

RAW 18 GAUGE STEEL
COLORS SHOWN EXAMPLES ONLY

ADD LIGHTS TO YOUR VISOR - SEE PAGES 106-107 FOR LIGHT OPTIONS

STAINLESS ACCESSORIES

PETERBILT STAINLESS TRIM

SLEEPER WRAPS

MOUNTS WITH STRONG 3M DOUBLE-SIDED TAPE



VP140005
PB SLEEPER WRAP -
FLAG - LG



VP140007
PB SLEEPER WRAP -
FLAMES - LG



VP140009
PB SLEEPER WRAP - STEER
HEAD - LG

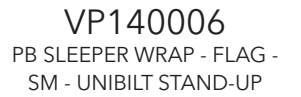

VP140006
PB SLEEPER WRAP - FLAG -
SM - UNIBILT STAND-UP



VP140008
PB SLEEPER WRAP - FLAMES -
SM - UNIBILT STAND-UP

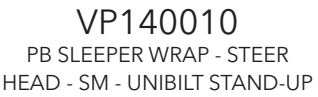

VP140010
PB SLEEPER WRAP - STEER
HEAD - SM - UNIBILT STAND-UP



VP140023
PB SLEEPER WRAP -
GIRLS - LG



VP140018
PB SLEEPER WRAP -
PLAIN - LG - FLAT TOP CAB

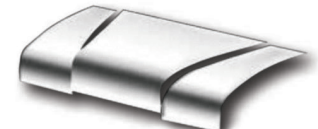

VP140011
PB SLEEPER WRAP -
PLAIN - LG - FLAT TOP - 3PC

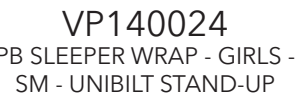

VP140024
PB SLEEPER WRAP - GIRLS -
SM - UNIBILT STAND-UP



VP140019
PB SLEEPER WRAP - PLAIN -
SM - ULTRA CAB

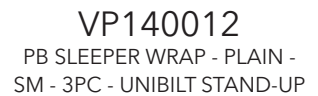

VP140012
PB SLEEPER WRAP - PLAIN -
SM - 3PC - UNIBILT STAND-UP



VP140015
PB SLEEPER WRAP - PLAIN -
SM - SIDES - 2PCS



VP140016
PB SLEEPER WRAP - PLAIN -
LG - SIDES - 2PCS

REAR FRAME COVERS

MOUNTS USING EXISTING FRAME BOLTS



VP160001
PB - REAR FRAME COVER -
379



VP160003
PB - REAR FRAME COVER -
WILDFIRE



VP160004
PB - REAR FRAME COVER -
ELLIPSE



VP160005
PB - REAR FRAME COVER -
OVAL - W/CUTOUTS

WILL NOT WORK WITH
ALUMINUM FRAMES



VP160006
PB - REAR FRAME COVER -
STEER HEAD

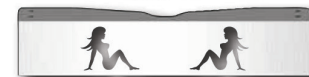

VP160007
PB - REAR FRAME COVER -
GIRLS

STAINLESS ACCESSORIES

PETERBILT STAINLESS TRIM

DEF TANK COVERS

MOUNTS TO EXISTING HARDWARE



VP150028
DEF FUEL TANK COVER -
STAINLESS

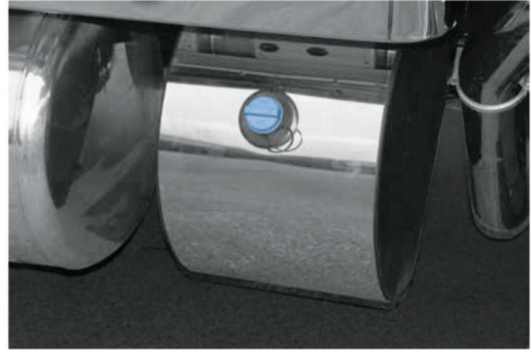

FUEL TANK WRAPS

MOUNTS BEHIND FUEL TANK STRAPS
STRONG 3M DOUBLE-SIDED TAPE ALSO INCLUDED

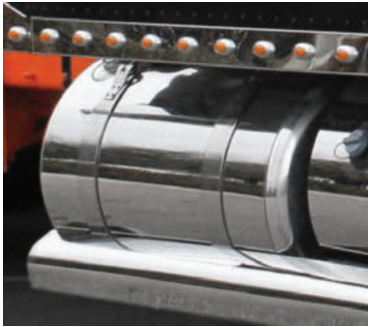

VP150041
DRIVER SIDE
PB - 2012 FUEL TANK WRAP -
75 GALLON

VP150041-PS
PASSENGER SIDE
PB - 2012 FUEL TANK WRAP -
75 GALLON

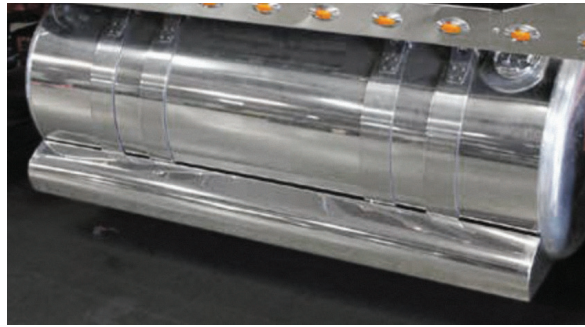

VP150040
DRIVER SIDE
PB - 2012 FUEL TANK WRAP -
150 GALLON

VP150040-PS
PASSENGER SIDE
PB - 2012 FUEL TANK WRAP -
150 GALLON

SPECIFY TANK LENGTH, INSIDE WELD TO INSIDE WELD WHEN ORDERING

STAINLESS ACCESSORIES

KENWORTH W900



Bumpers and Stainless Accessories made in the USA



www.valleychrome.com

STAINLESS ACCESSORIES

KENWORTH W900

CAB PANELS

MOUNTING HARDWARE INCLUDED



VK110205

W900L - 2014 - HIGHLIGHT -
BLANK - 2 PCS



VK110206

W900L - 2014 - HIGHLIGHT
- BLANK - W/ LIGHT HOLE -
HEATER PLUG HOLE



VK110200

W900L - AEROCAB - CAB
PANELS - 50.25" - BLANK



VK110216

W900L - AEROCAB - CAB
PANELS - 50.25" - BLANK

ADD LIGHTS TO YOUR PANEL - SEE PAGES 106-107

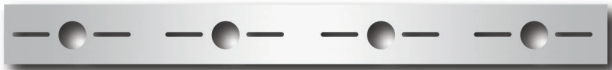

EXAMPLE

VK110200-4UN



EXAMPLE

VK110200-5RN

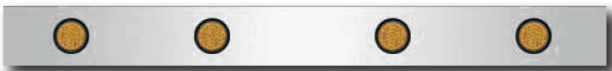

EXAMPLE

VK110200-4RA



EXAMPLE

VK110200-4GA



VK110200-3GA shown

STAINLESS ACCESSORIES

KENWORTH W900

SLEEPER PANELS

MOUNTING HARDWARE INCLUDED



VK142035

KW SLEEPER PANELS - T600
(1995 & NEWER, NO FAIRINGS)
T800 (1986 & NEWER), W900
(1986 & NEWER) - 42" - BLANK

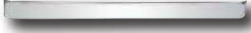

VK142008

KW SLEEPER PANELS -
AEROCAB - NO SIDE FAIRING -
T600, T800, W900 - 60" - BLANK
- 1995 & NEWER
WRAPS ON BOTH ENDS

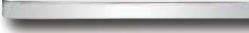

VK142015

KW SLEEPER PANELS -
AEROCAB - NO SIDE FAIRING -
T600, T800, W900 - 72" - BLANK



VK142023

KW SLEEPER PANELS -
AEROCAB - NO SIDE FAIRING
- T600, T800, W900 - 86" -
BLANK



VK142030

KW SLEEPER PANELS -
AEROCAB - NO SIDE FAIRING,
PASS SIDE NOTCHED FOR EXH -
T600, T800, W900 - 62" - BLANK



VK142100

KW SLEEPER PANELS -
AEROCAB - W/EXHAUST -
W900 L - 62" - BLANK



VK142101

KW SLEEPER PANELS -
AEROCAB - W/EXHAUST
- W900 L - 72" - BLANK



VK142105

KW SLEEPER PANELS -
AEROCAB - W/FUEL DOOR -
W900 L - 86" - BLANK



VK142200

KW SLEEPER PANELS - 2014
AEROCAB - 62" - BLANK - 2 PCS

ADD LIGHTS TO YOUR PANEL - SEE PAGES 106-107



EXAMPLE
VK142008-3UN



EXAMPLE
VK142008-5RA



EXAMPLE
VK142023-8GA

SLEEPER EXTENSION PANELS

MOUNTING HARDWARE INCLUDED



VK143001

SLEEPER EXTENSION PANELS
- T600, T800, W900 - BLANK -
1992 - 2012



EXAMPLE

VK143001-1GA

STAINLESS ACCESSORIES

KENWORTH W900

HOOD EXTENSION PANELS

MOUNTING HARDWARE INCLUDED



VK110300
HOOD EXTENSION PANELS -
W900L - BLANK - 1997-2004 -
2 PCS



VK110305
HOOD EXTENSION PANELS -
W900L - BLANK - 2014 - 2 PCS

ADD LIGHTS TO YOUR PANEL - SEE PAGES 106-107



EXAMPLE
VK110300-3UN



EXAMPLE
VK110300-4GA



STAINLESS ACCESSORIES

KENWORTH W900 AIR CLEANER LIGHT BOXES

MOUNTING HARDWARE INCLUDED

ADD LIGHTS TO YOUR PANEL
SEE PAGES 106-107



VK113000

AIR CLEANER LIGHT BOXES -
W900 - FRONT - BLANK

26"



VK113001

AIR CLEANER LIGHT
BOXES - W900 - CENTER
MOUNT - FRONT - BLANK

24"



VK110020

AIR CLEANER LIGHT BOXES -
W900 - REAR - BLANK

21"



VK112209

KW - AIR CLEANER
SUPPORT - BLANK -
W900L - 2014 - PAIR



VK113000-8RA

AIR CLEANER LIGHT BOXES -
W900 - FRONT - 8 ROUND AMBERS



VK113002

AIR CLEANER LIGHT
BAR - BLANK

KENWORTH W900 & W990 BUMPER SUPPORT BRACKETS



VK15-06333L-18

SUPPORT BRACKET
FOR 18" BUMPERS



VK15-06333L-22

SUPPORT BRACKET
FOR 22" BUMPERS



VK15-06333LW-18

SUPPORT BRACKET
FOR 18" BUMPERS

(WITH WATERMELON LIGHT CUTOUT)



VK15-06333LW-20

SUPPORT BRACKET
FOR 20" BUMPERS

(WITH WATERMELON LIGHT CUTOUT)



VK15-06333LW-22

SUPPORT BRACKET
FOR 22" BUMPERS

(WITH WATERMELON LIGHT CUTOUT)

STAINLESS ACCESSORIES

KENWORTH W900

AIR CLEANER FAIRINGS



VK100013
AIR CLEANER FAIRING W9L PR



VK100020
AIR CLEANER FAIRING W9L
PR 2014



VK100022
AIR CLEANER FAIRING W9L PAIR
2014 - SLIM VERSION



STAINLESS ACCESSORIES

KENWORTH W900

EXTERIOR WINDOW TRIM

MOUNTS WITH STRONG 3M DOUBLE-SIDED TAPE



VK110021
2014 KW WINDSHIELD
TRIM - 4 PC - W900 CURVED
WINDSHIELD

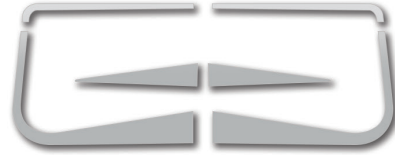

VK110018
2014 KW WINDSHIELD TRIM
- 6 PC - W900 - CURVED
WINDSHIELD - LARGE

EXHAUST SHIELDS

BRACKETS AND MOUNTING HARDWARE INCLUDED



VK110090
KW EXHAUST SHIELD W/NO
LOGO W900B



BUG SHIELDS

MOUNTING HARDWARE INCLUDED



VK120023
KW BUGSHIELD TRIM - W900L -
HIGHLIGHT ONLY
STAINLESS HIGHLIGHT



VK120024
KW BUGSHIELD TRIM - W900L -
FLAME - ONLY
STAINLESS HIGHLIGHT



VK120009
KW STAINLESS BUG SHIELD
- 900L



VK120010
KW STAINLESS BUG SHIELD
- 900B

STAINLESS ACCESSORIES

KENWORTH W900

BLINKER BARS

RUBBER TRIM AND MOUNTING HARDWARE INCLUDED



VK120501
KW - W900L FRONT BLINKER
BARS W/LIGHTS



VK100501
KW - W900L REAR BLINKER
BARS W/LIGHTS

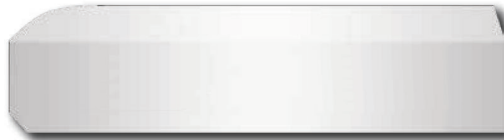

VK120501BL
KW - W900L FRONT BLINKER
BARS BLANK

ADD LIGHTS TO YOUR BLINKER BAR - SEE PAGES 106-107



FLAP WEIGHTS



VK190001
2014 W900 L - FRONT FENDER
FLAP WEIGHTS - 2 PCS

STAINLESS ACCESSORIES

KENWORTH W900

FENDER GUARDS



VK120019



VK120016
KW - FENDER GUARDS -
W900L - 1989 & NEWER - PAIR



VK120017
KW - FENDER GUARDS -
W900L - FLUSH MOUNT
1989 & NEWER - PAIR



VK120019
KW - FENDER GUARDS -
W900B - FLUSH MOUNT
1989 & NEWER - PAIR

BATTERY & TOOL BOX COVERS



VK150004
KW - BATTERY BOX COVER -
T600, T800, W900 - 39.5" X 9.0"

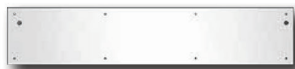

VK150005
KW - BATTERY BOX COVER -
T600, T800, W900 - 45" X 9"



VK150006
KW - TOOL BOX COVER - T600,
T800, W900 - 39.5" X 8.5"



VK150007
KW - TOOL BOX COVER - T600,
T800, W900 - 45" X 8.5"

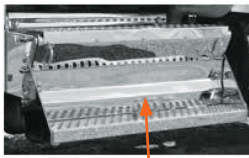

VK150030
2014- W900 L - BATTERY BOX
STEP COVER



VK150031
2014- W900 L - BATTERY
COVER HIGHLIGHT - 2 PCS

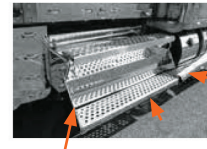

VK150032
2014- W900 L - BATTERY BOX
STEP HIGHLIGHT - 5 PCS

STAINLESS ACCESSORIES

KENWORTH W900

HOOD & GRILLE TRIM



VK120002
W9L LOWER GRILL FILTER TRIM



VK120001
W900L TOP GRILL
DEFLECTORS - PAIR



11151
HOOD WING -
POWER STYLE

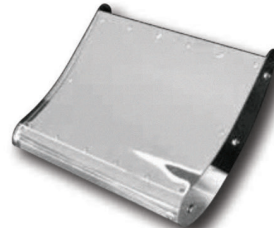

11191
FENDER WINGS -
POWERSTYLE



22281
SIDE HOOD WINGS



VK120007
KW SIDE GRILL DEFLECTOR -
FULL LENGTH - W900L



VK120008
KW SIDE GRILL DEFLECTOR -
FOR USE WITH BLINKER BAR
- W900L



VK120004
KW SIDE GRILL DEFLECTORS



VK120008

STAINLESS ACCESSORIES

KENWORTH W900

STAINLESS SUN VISORS

MOUNTING HARDWARE INCLUDED



VK130001

VK-13" - DROP VISOR - W900
AEROCAB CURVED - 1995 - 2006

VK131001

KW - 13" - DROP VISOR - W900
AEROCAB CURVED 1995 & 2006 -
1PC - BOLTLESS

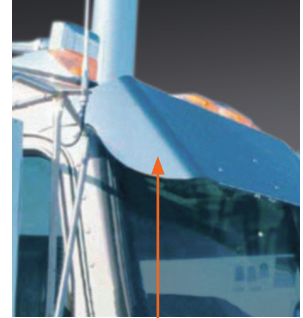

VK130001



VK130002

KW - 13" - DROP VISOR - W900 - CABS W/
SPLIT FLAT WINDSHIELDS 1984 TO 1998

VK131002

KW - 13" - DROP VISOR - W900 - CABS
W/ SPLIT FLAT WINDSHIELDS 1984 TO
1998 - 1PC - BOLTLESS



VK130002



VK130003

KW - 11" - DROP VISOR - (W900 2007-
2013) - (T660, T800 2007-2024)-
CURVED WINDSHIELD

VK131003

KW - 11" - DROP VISOR - W900 - T660 -
CURVED WINDSHIELD - 2007 & NEWER
- 1PC - BOLTLESS

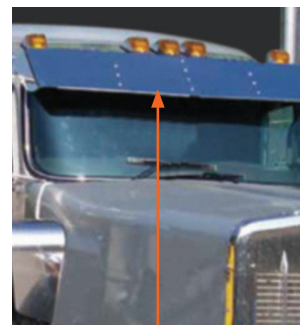

VK130003



VK130004

KW - 13" - DROP VISOR - W900 - CABS W/
SPLIT FLAT WINDSHIELD 1999 TO 2004

VK131004

KW - 13" - DROP VISOR - W900 - CABS W/
SPLIT FLAT WINDSHIELD 1999 TO 2004 -
1PC - BOLTLESS

STAINLESS ACCESSORIES

KENWORTH W900

GANGSTER VISORS

MOUNTING HARDWARE INCLUDED



VK132001
GANGSTER VISOR - DROP
W900 - CURVED WINDSHIELD
1995 - 2006 - 2 PC



VK132003
GANGSTER VISOR - DROP
W900, T660, T800
CURVED WINDSHIELD
2007 - NEWER - 2 PC



VK132001P
GANGSTER VISOR
PAINTABLE - DROP - W900
CURVED WINDSHIELD
1995-2006 - 2 PC
RAW 18-GAUGE STEEL



VK132001-BF
GANGSTER BUTTERFLY
VISOR - DROP - W900
CURVED WINDSHIELD
1995 - 2006 - 2 PC

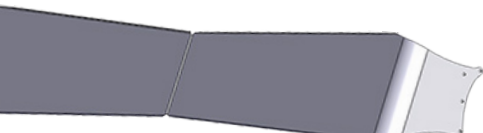

VK132001P-BF
GANGSTER BUTTERFLY
VISOR PAINTABLE - DROP - W900 -
CURVED WINDSHIELD - 1995 - 2006- 2 PC
RAW 18-GAUGE STEEL



VK132010
12" GANGSTER DROP VISOR
2007-NEWER (2 PIECE)
(FITS TRUCKS WITH CURVED WIND-
SHIELD)

VK132010G
12" GANGSTER DROP VISOR
2007-NEWER (1 PIECE)
(FITS TRUCKS WITH CURVED WIND-
SHIELD)

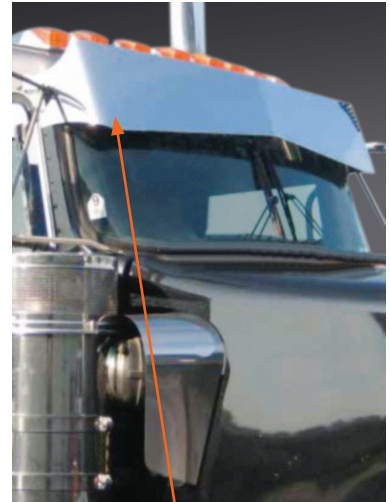

VK132003-BF



VK132003-BF

ADD LIGHTS TO YOUR VISOR - SEE PAGES 106-107 FOR LIGHT OPTIONS

STAINLESS ACCESSORIES

KENWORTH W900

BOLTLESS WICKED VISORS

MOUNTING HARDWARE INCLUDED



VK135001
KW - 13" - WICKED - DROP
- W900 AEROCAB CURVED
1995-2006 - 2 PIECE



VK135002
KW - 13" - WICKED - DROP
- W900 - CABS W/ SPLIT
FLAT WINDSHIELDS 1984
TO 1998 - 2 PIECE

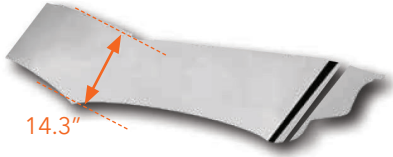

VK135003
KW - 14" - WICKED -
DROP - W900, T660, T800
- CURVED WINDSHIELD -
2007 & NEWER - 2 PIECE



VK135004
KW - 13" - WICKED -
DROP - W900 - CABS W/
SPLIT FLAT WINDSHIELD
1999 & NEWER - 2PIECE

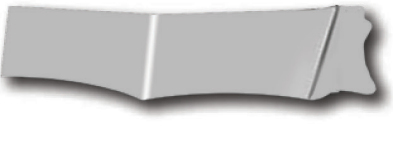

VK136001
KW - 14" - WICKED
GANGSTER - W900 -
CURVED WINDSHIELD -
1995-2006 - 2 PIECE

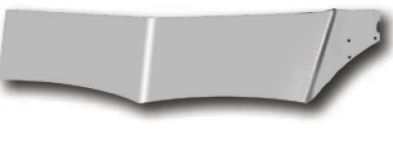

VK136003
KW - 14" - WICKED
GANGSTER - W900,
T660, T800 - CURVED
WINDSHIELD -
2007-NEWER - 2 PIECE

**PAINTABLE
VISORS
AVAILABLE**

JUST ADD "P" TO THE END
FOR PAINTABLE. EXAMPLE:

VK135002-P
RAW 18 GAUGE STEEL

**COOL
BOLTLESS
LOOK!**



VK135001

YOU SAY
WICKED
LIKE IT'S A BAD THING

ADD LIGHTS TO YOUR VISOR - SEE PAGES 106-107

STAINLESS ACCESSORIES

KENWORTH W900

CATALYTIC SYSTEM BOX HIGHLIGHT



VK150020
2014- W900 L - CATALYTIC
STEP COVER



VK150021
2014- W900 L - CATALYTIC
COVER HIGHLIGHT - 2 PCS



VK150022
2014- W900 L - CATALYTIC
STEP HIGHLIGHTS - 5 PCS

DEF TANK COVER



VK150028
KW - 2014 W900 L - DEF
TANK COVER



STAINLESS DECK PLATES



VK192010
FRONT DECK PLATE FLUSH MOUNT - W/
AIR LINE BOX CUTOUT - 2014 W900 L



VK192011
MID DECK PLATE FLUSH MOUNT -
2014 W900 L - 66"X27"



VK192012
REAR DECK PLATE - FLUSH MOUNT -
2014 W900 L

STAINLESS ACCESSORIES

KENWORTH W900

FUEL TANK FAIRINGS

BRACKETS & MOUNTING HARDWARE INCLUDED
NOT AVAILABLE IN 430 STAINLESS
FAIRINGS FOR STANDARD WIDTH TANK STRAPS SHOWN



60"

VK150001

KW - FUEL TANK FAIRINGS 60"
- W900 - 1998 & NEWER - PAIR



66"

VK150002

KW - FUEL TANK FAIRINGS 66"
- W900 - 1998 & NEWER - PAIR



73"

VK150003

KW - FUEL TANK FAIRINGS
73" - W900 - 1998 & NEWER - PAIR

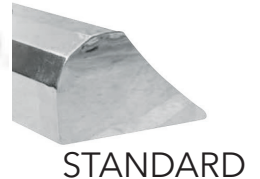

STANDARD



VK150001R

KW - FUEL TANK FAIRINGS
60" - ROUND - W900 - 1998 &
NEWER



VK150002R

KW - FUEL TANK FAIRINGS 14"
66" - ROUND - W900 - 1998 &
NEWER



VK150003R

KW - FUEL TANK FAIRINGS
73" - ROUND - W900 - 1998 &
NEWER



ROUNDED

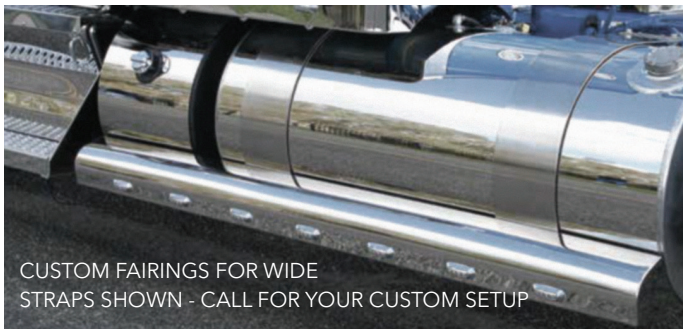

CUSTOM FAIRINGS FOR WIDE
STRAPS SHOWN - CALL FOR YOUR CUSTOM SETUP



EXAMPLE

VK150003-5GA

ADD LIGHTS TO YOUR FAIRING - SEE PAGES 106-107

VC VALLEY
CHROME
PLATING

STAINLESS ACCESSORIES

KENWORTH W900

LOWER HOOD PANELS

KENWORTH LOGO NOT INCLUDED



VK100016

KW - LOWER HOOD PANELS -
W900 1989 & NEWER - PR

CENTER HOOD TRIM



VK100021

KW - W900L CENTER
HOOD TRIM
TAPE MOUNT

STAINLESS ACCESSORIES

KENWORTH T600



Photo submitted by Tony St Bernard

STAINLESS ACCESSORIES

KENWORTH T600

SLEEPER PANELS



VK142035

KW SLEEPER PANELS - T600
(1995 & NEWER, NO FAIRINGS)
T800 (1986 & NEWER), W900
(1986 & NEWER) - 42" - BLANK



VK142008

KW SLEEPER PANELS -
AEROCAB - NO SIDE FAIRING -
T600, T800, W900 - 60" - BLANK
- 1995 & NEWER



VK142015

KW SLEEPER PANELS -
AEROCAB - NO SIDE FAIRING -
T600, T800, W900 - 72" - BLANK



VK142023

KW SLEEPER PANELS -
AEROCAB - NO SIDE FAIRING
- T600, T800, W900 - 86" -
BLANK



VK142030

KW SLEEPER PANELS -
AEROCAB - NO SIDE FAIRING
, PASS SIDE NOTCHED FOR
EXH - T600, T800, W900 - 62"
- BLANK

ADD LIGHTS TO YOUR PANEL - SEE PAGES 106-107



EXAMPLE

VK142008-3UN



EXAMPLE

VK142008-5RA



EXAMPLE

VK142023-8GA

SLEEPER EXTENSION PANELS

MOUNTING HARDWARE INCLUDED



VK143001

SLEEPER EXTENSION PANELS
- T600, T800, W900 - BLANK -
1992 - 2012



EXAMPLE

VK143001-1GA

STAINLESS ACCESSORIES

KENWORTH T600

STAINLESS GRILLES

MOUNTING HARDWARE INCLUDED



VK120600
KW GRILL T600B -
HORIZONTAL - RIVETED

BUG SHIELDS

MOUNTING HARDWARE INCLUDED



VK120012
KW STAINLESS BUG SHIELD
- T600



STAINLESS ACCESSORIES

KENWORTH T600

BATTERY & TOOL BOX COVERS



VK150004

KW - BATTERY BOX COVER -
T600, T800, W900 - 39.5" X 9.0"



VK150005

KW - BATTERY BOX COVER -
T600, T800, W900 - 45" X 9"



VK150006

KW - TOOL BOX COVER -
T600, T800, W900 - 39.5" X 8.5"



VK150007

KW - TOOL BOX COVER - T600,
T800, W900 - 45" X 8.5"

SIDE MARKER TRIM



VK140001

T600 SIDE MARKER LIGHT
ACCENT TRIM - PAIR



STAINLESS ACCESSORIES

KENWORTH T660



Bumpers and Stainless Accessories made in the USA



www.valleychrome.com

STAINLESS ACCESSORIES

KENWORTH T660

CAB PANELS

MOUNTING HARDWARE INCLUDED



VK110201
T660 - CAB PANELS - BLANK"

ADD LIGHTS TO YOUR PANEL - SEE PAGES 106-107

BUG SHIELDS

MOUNTING HARDWARE INCLUDED



VK120015
KW STAINLESS BUG SHIELD
- T660



STAINLESS SUN VISORS

MOUNTING HARDWARE INCLUDED



VK130003
KW - 13" - DROP VISOR - (W900 2007-
2013) - (T660, T800 2007-2015)-
CURVED WINDSHIELD

VK131003
KW - 13" - DROP VISOR - W900 - T660 -
CURVED WINDSHIELD - 2007 & NEWER
- 1PC - BOLTLESS

STAINLESS ACCESSORIES

KENWORTH T660

GANGSTER VISORS

MOUNTING HARDWARE INCLUDED



VK132003

KW - 12" - GANGSTER VISOR
DROP - W900, T660, T800 - CURVED
WINDSHIELD - 2007 & NEWER - 2 PC

VK132003 - BF

KW - 12" - GANGSTER VISOR - BUTTERFLY
DROP - W900, T660, T800 - CURVED
WINDSHIELD - 2007 & NEWER - 2 PC



VK132003-BF

**ABOVE VISORS ARE
ONLY AVAILABLE IN 12"**

BOLTLESS WICKED VISORS

MOUNTING HARDWARE INCLUDED

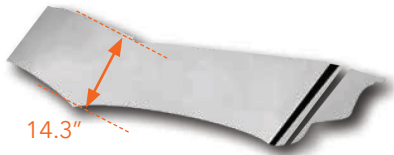

14.3"

VK135003

KW - 14" - WICKED -
DROP - W900, T660, T800
- CURVED WINDSHIELD -
2007 & NEWER - 2 PIECE

**COOL
BOLTLESS
LOOK!**



VK136003

KW - 14" - WICKED
GANGSTER - W900,
T660, T800 - CURVED
WINDSHIELD -
2007-NEWER - 2 PIECE

YOU SAY
WICKED
LIKE IT'S A BAD THING

STAINLESS ACCESSORIES

KENWORTH T660

BATTERY & TOOL BOX COVERS



VK150008
T660 DAY CAB BATTERY BOX
HIGHLIGHT

STAINLESS ACCESSORIES

KENWORTH T680



- 1** VK110028 Top of door trim - "lowered" look
- 2** VK110209 Cab Panel - Blank (VK110209-3GA shown)
- 3** VK150029 DEF Tank Cover
- 4** VK120101 Bug shield
- 5** VK130007 12" drop visor
- 6** FV-0010-708 Chrome front bumper (other options available)

STAINLESS ACCESSORIES

KENWORTH T680

CAB & COWEL PANELS

MOUNTING HARDWARE INCLUDED



VK110209

2015 T680 - CAB PANELS - BLANK"
VERTICAL EXHAUST ONLY



VK110210

2016 T680 - CAB PANELS - BLANK



VK110211

2016 T680 - CAB PANELS - BLANK
W/HEATER PLUG HOLE

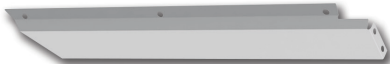

VK110210

(ALTERNATE VIEW)



VK110308

2021-2023 COWEL PANEL
(FITS HIGH-ROOF TRUCKS)



VK110308-4GSCA

2021-2023 COWEL PANEL
W/4 GRANITE SLIM CLEAR AMBER LIGHTS
(FITS HIGH-ROOF TRUCKS)

ADD LIGHTS TO YOUR PANEL - SEE PAGES 106-107

SLEEPER EXTENSION PANELS

MOUNTING HARDWARE INCLUDED



VK143001

SLEEPER EXTENSION PANELS
- T600, T800, W900 - BLANK -
1992 - 2012

DOOR AND WINDOW TRIM



VK110222

KW - T680 DOOR ENTRY KICK
PANELS - 4PCS UPPER &
LOWER



VK110028

KW T680 LOWERED LOOK - 2015

STAINLESS ACCESSORIES

KENWORTH T680

BUG SHIELDS

MOUNTING HARDWARE INCLUDED



VK120101
KW STAINLESS BUG SHIELD - T680



VK120104
KW STAINLESS BUG SHIELD
- T680
(FITS TRUCKS W/O HOOD MIRRORS)

FENDER GUARDS



VK120018
KW - T680 FENDER GUARDS
- FITTED - 4PCS. UPPER &
LOWER

STAINLESS SUN VISORS

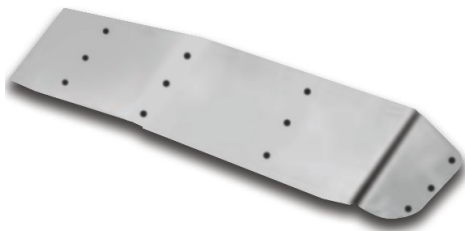

VK130007
KW - 13" - DROP - T680, T880 -
CURVED WINDSHIELD - 2015
REPLACES FACTORY VISOR ONLY

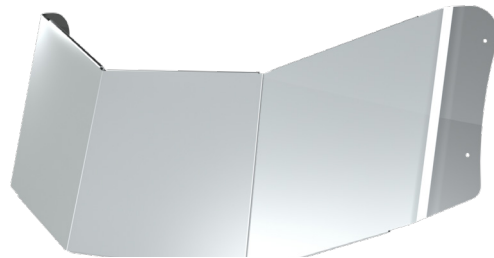

VK130008
KW - 15" DROP VISOR T680
MID-ROOF STANDUP SLEEPER
WITH NO EXISTING FACTORY VISOR
(ADD -16 TO END OF PN FOR 16")

STAINLESS ACCESSORIES

KENWORTH T680

DEF TANK COVER

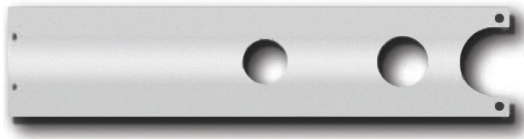

VK150029
KW - UREA TANK COVER 2015
T680

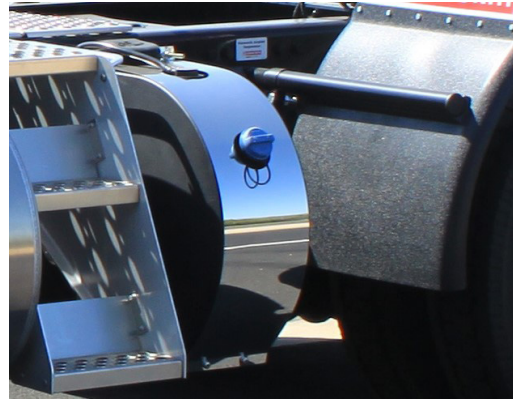

STAINLESS ACCESSORIES

KENWORTH T800 & T880



Bumpers and Stainless Accessories made in the USA



www.valleychrome.com

STAINLESS ACCESSORIES

KENWORTH T800 & T880

SLEEPER PANELS

MOUNTING HARDWARE INCLUDED



VK142035

KW SLEEPER PANELS - T600
(1995 & NEWER, NO FAIRINGS)
T800 (1986 & NEWER), W900
(1986 & NEWER) - 42" - BLANK



VK142008

KW SLEEPER PANELS -
AEROCAB - NO SIDE FAIRING -
T600, T800, W900 - 60" - BLANK
- 1995 & NEWER



VK142015

KW SLEEPER PANELS -
AEROCAB - NO SIDE FAIRING -
T600, T800, W900 - 72" - BLANK



VK142023

KW SLEEPER PANELS -
AEROCAB - NO SIDE FAIRING
- T600, T800, W900 - 86" -
BLANK



VK142039

T880, 76" SLEEPER PANEL
(FITS TRUCKS W/O VERT EXHAUST)



VK110216

T880 CAB PANEL
33.75" - BLANK

ADD LIGHTS TO YOUR PANEL - SEE PAGES 106-107



EXAMPLE
VK142008-3UN



EXAMPLE
VK142008-5RA



EXAMPLE
VK142023-8GA

SLEEPER EXTENSION PANELS

MOUNTING HARDWARE INCLUDED



VK143001

SLEEPER EXTENSION PANELS
- T600, T800, W900 - BLANK -
1992 - 2012



EXAMPLE
VK143001-1GA



VK142037

40" SLEEPER PANEL
T880 - BLANK

STAINLESS ACCESSORIES

KENWORTH T800 & T880

BUG SHIELDS

MOUNTING HARDWARE INCLUDED



VK120013
KW STAINLESS BUG SHIELD
- T800

FENDER GUARDS



VK120022
KW - FENDER GUARDS - T-800
AERO CAB -1996 & NEWER - PAIR

STAINLESS SUN VISORS



VK130003
KW - 13" - DROP VISOR - (W900 2007-2013) - (T660,
T800 2007-2015)- CURVED WINDSHIELD
MOUNTING HARDWARE INCLUDED

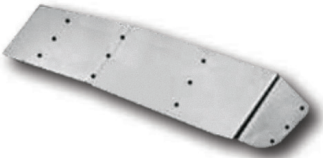

VK130007
KW - 13" - DROP - T680, T880 -
CURVED WINDSHIELD - 2015
DAY CAB ONLY
NO MOUNTING HARDWARE INCLUDED
REPLACES FACTORY VISOR ONLY

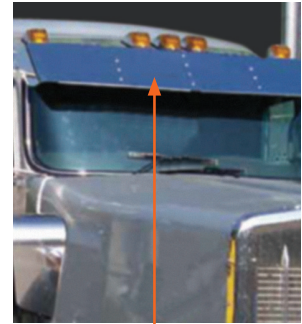

VK130003



VK120700
T880 BEHIND BUMPER TRIM

STAINLESS ACCESSORIES

KENWORTH T800 & T880

GANGSTER VISORS

MOUNTING HARDWARE INCLUDED



VK132003

KW - 12" - GANGSTER VISOR -
DROP - W900, T660, T800 - CURVED
WINDSHIELD - 2007 & NEWER - 2 PC

VK132003 - BF

KW - 12" - GANGSTER VISOR -
DROP - W900, T660, T800 - CURVED
WINDSHIELD - 2007 & NEWER - 2 PC

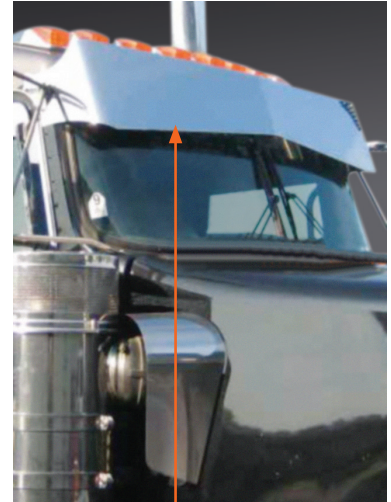

VK132003-BF

**ABOVE VISORS ARE
ONLY AVAILABLE IN 12"**

BOLTLESS WICKED VISORS

MOUNTING HARDWARE INCLUDED

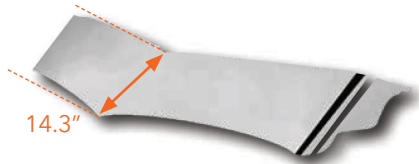

14.3"

VK135003

KW - 14" - WICKED -
DROP - W900, T660, T800
- CURVED WINDSHIELD -
2007 & NEWER - 2 PIECE

**COOL
BOLTLESS
LOOK!**



VK136003

KW - 14" - WICKED
GANGSTER - W900,
T660, T800 - CURVED
WINDSHIELD -
2007-NEWER - 2 PIECE

YOU SAY
WICKED
LIKE IT'S A BAD THING

ADD LIGHTS TO YOUR VISOR - SEE PAGES 106-107

STAINLESS ACCESSORIES

KENWORTH T800 & T880

BATTERY & TOOL BOX COVERS

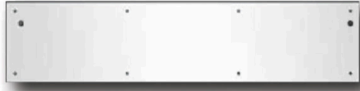

VK150004

KW - BATTERY BOX COVER -
T600, T800, W900 - 39.5" X 9.0"



VK150005

KW - BATTERY BOX COVER -
T600, T800, W900 - 45" X 9"



VK150006

KW - TOOL BOX COVER - T600,
T800, W900 - 39.5" X 8.5"



VK150007

KW - TOOL BOX COVER - T600,
T800, W900 - 45" X 8.5"



STAINLESS ACCESSORIES

ALL KENWORTH MODELS

EXTERIOR WINDOW TRIM

MOUNTS WITH STRONG 3M DOUBLE-SIDED TAPE



VK110002
KW DAYLIGHT DOOR OUTER
TRIM - 6PC



VK110012
KW EXTERIOR WINDOW TRIM
- PASSENGER DOOR VIEW -
DAYLIGHT DOOR



VK110013
KW EXTERIOR WINDOW TRIM
PASSENGER DOOR VIEW

DOOR HANDLE TRIM



VK110003
PB, KW STAINLESS DOOR
HANDLE TRIM - PAIR



VK110001
T300 T600 T800 W900
WINDOW AIR DEFLECTORS PAIR



VK110017
KW WINDOW LOWERED LOOK 4.5"
FITS DAYLIGHT DOOR ONLY



VK120101
KW BUG SHIELD
FITS T680 & T880 TRUCKS



VK110030
KW WINDOW LOWERED LOOK
FITS T680 & T880 TRUCKS W/PAS-
SENGER MIRROR

FENDER TRIM



VK120020
T480 FENDER TRIM

STAINLESS ACCESSORIES

ALL KENWORTH MODELS

EMBLEM ACCENTS

KENWORTH LOGO NOT INCLUDED



VK100001
EMBLEM ACCENT
OLD GLORY - PAIR
TAPE MOUNT



VK100002
EMBLEM ACCENT
3 POINT SLOTTED - PAIR
HARDWARE INCLUDED - PAIR



VK100003
EMBLEM ACCENT
FLAMES - PAIR
TAPE MOUNT



VK100004
EMBLEM ACCENT
HIGH LIGHT - PAIR
HARDWARE INCLUDED



VK100005
EMBLEM ACCENT
3 POINT - PAIR
HARDWARE INCLUDED



VK100006
EMBLEM ACCENT
SATURN - PAIR
HARDWARE INCLUDED



VK100007
EMBLEM ACCENT
SHORT SATURN - PAIR
HARDWARE INCLUDED



VK100008
EMBLEM ACCENT
3-D LOOK - PAIR
HARDWARE INCLUDED



VK100009
EMBLEM ACCENT
VICTORY LANE - PAIR
HARDWARE INCLUDED



VK100012
EMBLEM ACCENT
U SHAPED UNDERLINE
HARDWARE INCLUDED



VK100015
EMBLEM ACCENT
OVAL W/ UPWARD FLAME
TAPE MOUNT

HOOD LATCH GUARDS



VK100017
KW - HOOD LATCH GUARDS
T222, T800, W900 1989 &
NEWER - PAIR



VK100018
KW - HOOD LATCH GUARDS
ALL MODELS W/ BALL LATCH
1968 -1989 - PAIR



VU190011
PB, FL, KW, HOOD LATCH
ACCENT TRIM - PAIR

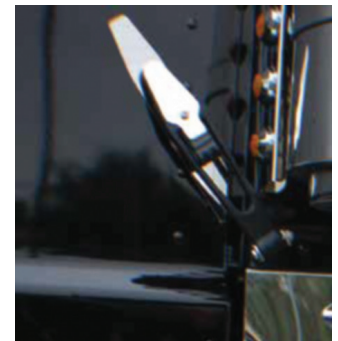

STAINLESS ACCESSORIES

ALL KENWORTH MODELS

SLEEPER WINDOW TRIM



VK140002
W9L SLEEPER
WINDOW TRIM - PAIR



VK140003
KW 72" SLEEPER
UPPER WINDOW TRIM
(SLIDING OR SWING) PAIR



VK140004
KW 86" STUDIO SLEEPER UPPER
SLIDING WINDOW TRIM PAIR

REAR FRAME COVERS



VK160001
KW - REAR FRAME COVER -
1992 & NEWER



VK160002
KW - REAR FRAME COVER -
STEER HEAD - 1992 & NEWER

STAINLESS FUEL TANK WRAPS



VK150040
KW - 2014 FUEL TANK -
HYDRAULIC TANK COMBO
WRAP - 72"



VK150041
KW - 2014 FUEL TANK WRAP -
75 GALLON - 57"



STAINLESS ACCESSORIES

FREIGHTLINER FLD/CLASSIC



Bumpers and Stainless Accessories made in the USA



www.valleychrome.com

STAINLESS ACCESSORIES

FREIGHTLINER FLD / CLASSIC

CAB PANELS 4"

MOUNTING HARDWARE INCLUDED



VF110015
FL - CAB PANEL - BLANK -
PAIR - 1991 NEWER CLASSIC

ADD LIGHTS TO YOUR PANEL - SEE PAGES 106-107



EXAMPLE
VF110015-3UN



EXAMPLE
VF110015-4GA

SLEEPER PANELS

MOUNTING HARDWARE INCLUDED

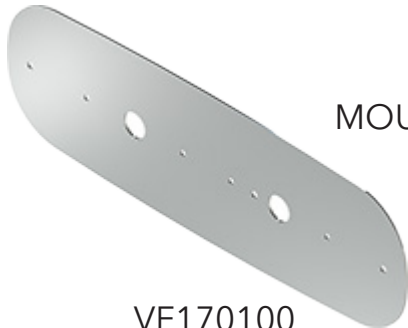

VF170100
CASCADIA INTERIOR SLEEPER
WATERMELON LIGHT PLATE



VF142003
2001 CLASSIC XL INTEGRAL SLEEPER NO AERO
WINGS - 48" SLEEPER PANELS - PAIR- BLANK

STAINLESS ACCESSORIES

FREIGHTLINER FLD / CLASSIC

HOOD LATCH GUARDS



VF100001

FL - HOOD LATCH GUARDS -
CLASSIC 1993 & NEWER - PAIR



VF100005

FL - HOOD LATCH GUARDS -
CLASSIC X L -
1993 & NEWER - PAIR



VU190011

PB, FL, KW, HOOD LATCH
ACCENT TRIM - PAIR

HOOD TRIM



VF100010

FL CLASSIC FRONT SIDE OF
HOOD
TRIM W/ FLAMES PAIR



VF100011

FL - LOWER HOOD PANELS -
CLASSIC X L - 1993 & NEWER -
PAIR

LOWERED LOOK WINDOW PANELS



VF110018

FLD & CLASSIC 5.75" LOWERED
LOOK WINDOW PANELS

STAINLESS ACCESSORIES

FREIGHTLINER FLD / CLASSIC

MISC. TRIM PIECES



VF110013
FL- DOOR LATCH TRIM -
CENTURY / COLUMBIA /
CLASSIC FLD - PAIR



VF114001
FREIGHTLINER CLASSIC - HOOD
EXTENSION PANEL - LAY-OVER - PAIR

AIR CLEANER LIGHT BOXES



VF112001
FL - CLASSIC - FRONT - AIR
CLEANER LIGHT BOXES -
BLANK - PAIR

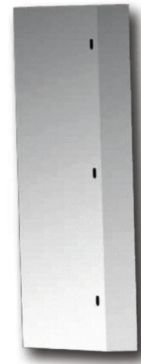

VF113001
FL - CLASSIC - REAR - AIR
CLEANER LIGHT BOXES -
BLANK - PAIR

ADD LIGHTS TO YOUR LIGHT BOX - SEE PAGES 106-107

STAINLESS ACCESSORIES

FREIGHTLINER FLD / CLASSIC

FENDER GUARDS



VF120003
FL CLASSIC & X L UPPER
FENDER GUARDS (SHORT &
LONG HOOD) PAIR



VF120004
FL - FENDER GUARDS -
EXTENDED HOOD - CLASSIC
- 1993 & NEWER - PAIR



VF120007
FL - FENDER GUARDS - FLD
120 - 1989 & NEWER

STAINLESS TRIM FOR PLASTIC BUMPERS



VF120001
FLD SETBACK AXLE
BUMPER TRIM KIT
W/ 1 TOW PIN & FOG LIGHT
HOLES 3 PC

ALSO CHECK OUT OUR
EXTENSIVE LINE OF FULL METAL
REPLACEMENT BUMPERS:
CLASSIC, PAGES 11-13
FLD SETBACKS, PAGES 15-18



STAINLESS ACCESSORIES

FREIGHTLINER FLD / CLASSIC

BUG SHIELDS

RUBBER TRIM & MOUNTING HARDWARE INCLUDED



VF120010
FL - BUG SHIELD - STAINLESS
- CLASSIC & CLASSIC XL



VF120011
FL - BUG SHIELD - STAINLESS
- FLD 120



STAINLESS ACCESSORIES

FREIGHTLINER FLD / CLASSIC

SUN VISORS



VF130001
FL - 18" DROP VISOR - CLASSIC RAISED
ROOF CONDO - 9 - 2" ROUND -
NO LIGHTS INCLUDED



VF130002
FL - 18" DROP VISOR - CLASSIC MID ROOF -
9 - 2" RD - NO LIGHTS INCLUDED



VF130006
FL-13" - DROP VISOR - CLASSIC XL FLAT
TOP - REPLACES FACTORY STAINLESS ONLY -
DOES NOT REPLACE FIBERGLASS.
DOES NOT WORK WITH TRUCKS WITHOUT EXISTNG VISOR.

**PAINTABLE
VISORS
AVAILABLE**

JUST ADD "P" TO THE END
FOR PAINTABLE. EXAMPLE:

VF130001P
RAW 18 GAUGE STEEL

ADD LIGHTS TO YOUR VISOR - SEE PAGES 106-107



VF132001G-RBF
FL -

STAINLESS ACCESSORIES

FREIGHTLINER FLD / CLASSIC

WICKED BOLTLESS VISORS



VF135001

FL - 18" - WICKED - DROP
VISOR - CLASSIC RAISED
ROOF CONDO - 9 - 2" ROUND -
NO LIGHTS INCLUDED - 2 PC

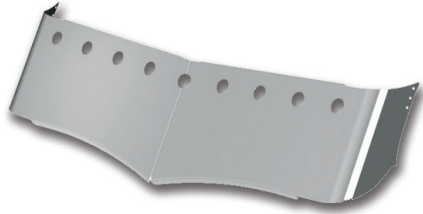

VF135002

FL - 18" - WICKED - DROP
VISOR - CLASSIC MID-ROOF -
9 - 2" RD - NO LIGHTS INCLUDED -
2 PC



VF135006

FL - 13" - WICKED - DROP
VISOR - CLASSIC XL - FLAT
TOP UP TO 2001 REPLACES
STAINLESS FACTORY VISOR - 2 PC

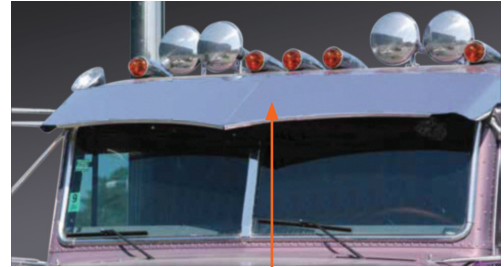

VF135006

YOU SAY
WICKED
LIKE IT'S A BAD THING

**COOL
BOLTLESS
LOOK!**

ADD LIGHTS TO YOUR VISOR - SEE PAGES 106-107



STAINLESS ACCESSORIES

FREIGHTLINER CENTURY & COLUMBIA



Bumpers and Stainless Accessories made in the USA



www.valleychrome.com

STAINLESS ACCESSORIES

FREIGHTLINER CENTURY & COLUMBIA

CAB PANELS 4"

MOUNTING HARDWARE INCLUDED

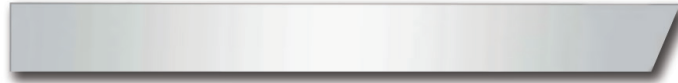

VF110020

FL - CAB PANEL - 4" - 2005
AND NEWER CENTURY/COLUMBIA

ADD LIGHTS TO YOUR PANEL - SEE PAGES 106-107

SLEEPER PANELS



VF140020

2005 AND NEWER CENTURY/
COLUMBIA SLEEPER PANEL +
EXTENSION - 1PC - 70" - BLANK

MISC. TRIM PIECES

MOUNTS WITH STRONG 3M DOUBLE-SIDED TAPE



VF110013

FL- DOOR LATCH TRIM -
CENTURY / COLUMBIA /
CLASSIC FLD - PAIR



VF110014

FL - VIEW WINDOW TRIM RING
- CENTURY / COLUMBIA



VF110019

FL - CENTURY / COLUMBIA UPPER CAB
HIGHLIGHT - 2PCS

STAINLESS ACCESSORIES

FREIGHTLINER CENTURY & COLUMBIA

STAINLESS TRIM FOR PLASTIC BUMPERS



VF120002
FL CENTURY PLASTIC BUMPER
TRIM
03-OLDER - 3 PC
TAPE MOUNT

ALSO CHECK OUT OUR
EXTENSIVE LINE OF FULL METAL
REPLACEMENT BUMPERS:
CENTURY, PAGES 19-20
COLUMBIA, PAGES 19-20



BUG SHIELDS

RUBBER TRIM & MOUNTING HARDWARE INCLUDED



VF120013
FL - BUG SHIELD - STAINLESS
- CENTURY



VF120014
FL - BUG SHIELD - STAINLESS
- COLUMBIA



STAINLESS ACCESSORIES

FREIGHTLINER CENTURY & COLUMBIA

SUN VISORS

BRACKETS AND MOUNTING HARDWARE INCLUDED
AVAILABLE IN 304 STAINLESS STEEL - CALL FOR PRICING



VF130003

FL-18" - DROP VISOR - RAISED ROOF
CENTURY - 2003 & OLDER - 10 - 2" ROUND -
HOLES - NO LIGHTS INCLUDED ALSO FITS 2009 &
OLDER CORONADO



VF130007

FL-18" DROP VISOR - RAISED ROOF CENTURY
& COLUMBIA - 2004 & NEWER - 10 - 2" RD
HOLES - NO LIGHTS INCLUDED



VF130014

FL - 14" DROP VISOR - 04
CORONADO DAY CAB 06 -
NEWER & COLUMBIA- NO LIGHTS
ONLY FOR TRUCKS WITHOUT EXISTING FACTORY VISOR

**PAINTABLE
VISORS
AVAILABLE**

JUST ADD "P" TO THE END
FOR PAINTABLE. EXAMPLE:

VF130003P
RAW 18 GAUGE STEEL

VF130016

FL - 16" DROP VISOR - 04
CENTURY/05 COLUMBIA MID
ROOF - NO LIGHTS

ADD LIGHTS TO YOUR VISOR - SEE PAGES 106-107

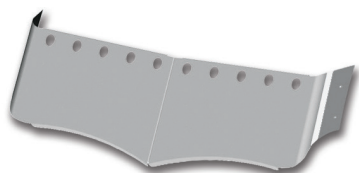

VF135003

FL - 18" - WICKED - DROP
VISOR - CENTURY-RAISED
ROOF - UP TO 2003 - 2 PC

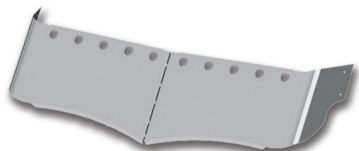

VF135007

FL - 18" - WICKED - DROP VISOR
- CENTURY & COLUMBIA 2004 -
NEWER - 2 PC - 10 2" ROUND HOLES
NO LIGHTS INCLUDED



VF135016

FL - 16" WICKED - DROP VISOR -
04 CENTURY/05 COLUMBIA MID
ROOF - NO LIGHTS

YOU SAY
WICKED
LIKE IT'S A BAD THING

**COOL
BOLTLESS
LOOK!**

STAINLESS ACCESSORIES

**FREIGHTLINER CORONADO 2002-2009
& GLIDER KITS**



Bumpers and Stainless Accessories made in the USA



www.valleychrome.com

STAINLESS ACCESSORIES

FREIGHTLINER CORONADO 2002-2009/GLIDERS

BUG SHIELDS

RUBBER TRIM & MOUNTING HARDWARE INCLUDED



VF120012
FL - BUG SHIELD - STAINLESS
- CORONADO



SUN VISORS

BRACKETS AND MOUNTING HARDWARE INCLUDED
AVAILABLE IN 304 STAINLESS STEEL - CALL FOR PRICING

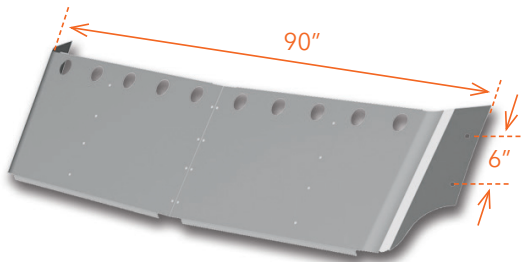

VF130003

FL-18" - DROP VISOR - RAISED ROOF
CENTURY - 2003 & OLDER - 10 - 2" ROUND -
HOLES - NO LIGHTS INCLUDED ALSO FITS 2009 &
OLDER CORONADO



VF130014

FL - 14" DROP VISOR - 04
CORONADO DAY CAB 06 -
NEWER & COLUMBIA- NO LIGHTS

ADD LIGHTS TO YOUR VISOR - SEE PAGES 106-107

STAINLESS ACCESSORIES

**FREIGHTLINER CASCADIA 2017
& OLDER "P3"**



Bumpers and Stainless Accessories made in the USA



www.valleychrome.com

STAINLESS ACCESSORIES

FREIGHTLINER CASCADIA 2017 & OLDER "P3"

CAB PANELS 4"

MOUNTING HARDWARE INCLUDED



VF110200
CAB PANEL 4" - CASCADIA -
BLANK PAIR

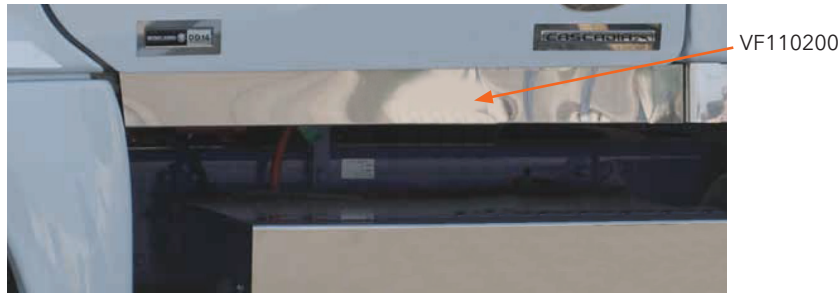

ADD LIGHTS TO YOUR PANEL - SEE PAGES 106-107

SLEEPER PANELS

MOUNTING HARDWARE INCLUDED



VF140010
CASCADIA SLEEPER PANEL 48"



VF142101
FL SLEEPER EXTENSION PANEL -
CASCADIA - 48" - BLANK



STAINLESS ACCESSORIES

FREIGHTLINER CASCADIA 2017 & OLDER "P3"

FAIRING PANELS

MOUNTS WITH STRONG 3M DOUBLE-SIDED TAPE

MID FAIRING KIT:



VF142009
2008 CASCADIA MID FAIRING
PANELS - 6 PCS - BLANK

LOWER FAIRING KIT:

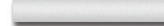

VF142012
2008 CASCADIA LOWER FAIRING
PANELS - 6 PCS - BLANK

UNDER FAIRING KIT:



VF142014
2008 CASCADIA MID FAIRING
PANELS - 6 PCS - BLANK

UNDER FAIRING INDIVIDUAL PIECES:



VF142014-1
2008 CASCADIA UNDER
FAIRING PANEL -
FRONT PASS SIDE



VF142014-2
2008 CASCADIA UNDER
FAIRING PANEL - MIDDLE
PASS SIDE



VF142014-3
2008 CASCADIA UNDER
FAIRING PANEL - REAR
PASS SIDE



VF142014-4
2008 CASCADIA UNDER
FAIRING PANEL - FRONT
DRIVERS SIDE



VF142014-5
2008 CASCADIA UNDER
FAIRING PANEL - MIDDLE
DRIVERS SIDE



VF142014-6
2008 CASCADIA UNDER
FAIRING PANEL - REAR
DRIVERS SIDE



Mid Fairing

Lower Fairing

Under Fairing

STAINLESS ACCESSORIES

FREIGHTLINER CASCADIA 2017 & OLDER "P3"

FENDER TRIM

MOUNTS WITH STRONG 3M DOUBLE-SIDED TAPE



VF100012

FL - CASCADIA FENDER TRIM - 2PC



VF100013

FL - CASCADIA FENDER TRIM EXT. - 2PC

HOOD & DOOR TRIM

MOUNTS WITH STRONG 3M DOUBLE-SIDED TAPE

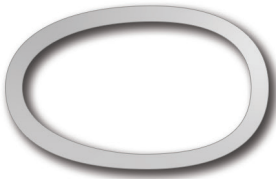

VF100016

FL - HOOD LIGHT TRIM - PAIR



VF100015

FL - CASCADIA AIR VENT ACCENT



VF110016

CASCADIA DOOR
HANDLE TRIM

LOWERED LOOK WINDOW PANELS

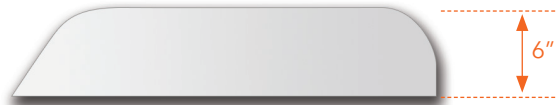

VF110017

CASCADIA LOWERED LOOK
WINDOW PANELS

ALSO FITS 2018 & NEWER P4 MODEL CASCADIAS

WATERMELON LIGHT BRACKETS



VF120200

SINGLE WATERMELON
SIDE MARKER PANEL

STAINLESS ACCESSORIES

FREIGHTLINER CASCADIA 2017 & OLDER "P3"

STAINLESS TRIM FOR PLASTIC BUMPERS



VF120017
CASCADIA FENDER TRIM -
ABOVE BUMPER - PAIR



VF120006
CASCADIA FT BUMPER TRIM
- 4PC - TAPE MOUNT



VF120017

VF120006

ALSO CHECK OUT OUR EXTENSIVE
LINE OF FULL METAL CASCADIA
REPLACEMENT BUMPERS:
PAGE 21-22



BUG SHIELDS

RUBBER TRIM & MOUNTING HARDWARE INCLUDED



VF120015
FL - BUG SHIELD - STAINLESS
- CASCADIA



STAINLESS ACCESSORIES

FREIGHTLINER CASCADIA 2017 & OLDER "P3"

SUN VISORS

BRACKETS AND MOUNTING HARDWARE INCLUDED
AVAILABLE IN 304 STAINLESS STEEL - CALL FOR PRICING



VF130017

FL - 18" STD MOUNT DROP VISOR
CASCADIA "P3" YRS. 2017 OLDER
CONDO/MID SLEEPER
FOR TRUCKS WITH OR WITHOUT FACTORY VISOR



**PAINTABLE
VISORS
AVAILABLE**

JUST ADD "P" TO THE END
FOR PAINTABLE. EXAMPLE:

VF130017-P
RAW 18 GAUGE STEEL

ADD LIGHTS TO YOUR VISOR - SEE PAGES 106-107



VF135017

FL - 18" WICKED DROP VISOR - 2PC
CASCADIA "P3" YRS. 2017 & OLDER
CASCADIA "P4" YRS. 2018 & NEWER
CONDO, MID ROOF
REPLACES FACTORY VISOR



VF130017BF

FL - 18" STD MOUNT BUTTERFLY VISOR
CASCADIA "P3" YRS. 2017 & OLDER
CONDO, MID ROOF
FOR TRUCKS WITH OR WITHOUT FACTORY VISOR



VF131017

FL - CASCADIA, 18" 1-PIECE VISOR (2010-2017) (FITS
CONDO SLEEPER)

**COOL
BOLTLESS
LOOK!**

STAINLESS ACCESSORIES

FREIGHTLINER CASCADIA 2017 & OLDER "P3"

FUEL TANK COVERS

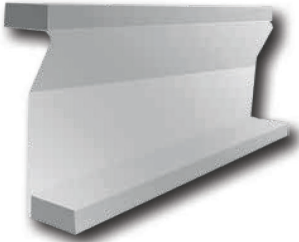

VF150006
FL - CASCADIA FUEL TANK
COVER W/STEPS - PASS SIDE

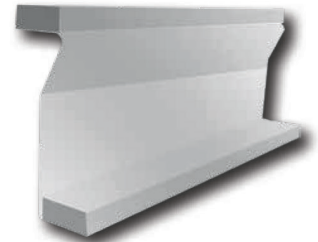
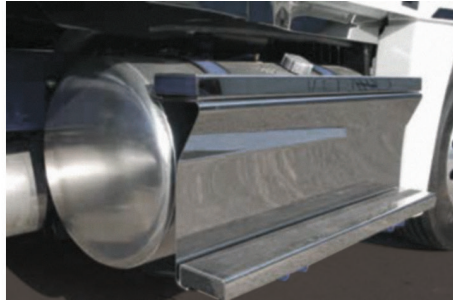

VF150007
FL - CASCADIA BATTERY BOX/
FUEL TANK COVER - 2011 DAY
CAB 34"

BATTERY BOX COVERS & STEPS



VF150000
FL - CASCADIA BATTERY
BOX COVER

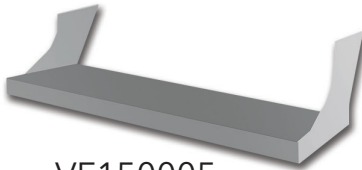

VF150005
FL - CASCADIA UNDER
BATTERY BOX STEP- 3PC.



VF150010
FL - CASCADIA BATTERY BOX
UPPER - 2011 DAY CAB 34"



VF150011
FL - CASCADIA BATTERY BOX
UPPER - 2011 DAY CAB 40"

CATALYTIC COVERS

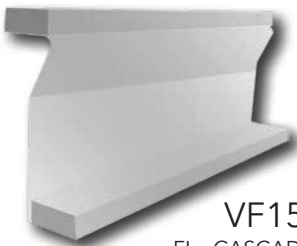

VF150008
FL - CASCADIA CATALYTIC
COVER - LOWER 2011 DAY
CAB 40"



VF150009
FL - CASCADIA CATALYTIC
COVER - UPPER 2011 DAY
CAB 40"

STAINLESS ACCESSORIES

FREIGHTLINER ACCESSORIES - ALL MODELS

EMBLEM ACCENTS



VF100002
FL - EMBLEM ACCENTS -
W/ CUTOUTS - PAIR
INCLUDES MOUNTING HARDWARE



VF100004
FL - EMBLEM ACCENTS -
16" - PAIR
TAPE MOUNT

PERMIT PANELS



VF110007
FL - PERMIT PANEL - EMBLEM
& CUTOUT - LEFT -
1998 & NEWER



VF110008
FL - PERMIT PANEL - PLUG
CUTOUT - LEFT -
1998 & NEWER



VF110009
FL - PERMIT PANEL - EMBLEM
CUTOUT - LEFT -
1998 & NEWER



VF110010
FL - PERMIT PANEL - BLANK -
LEFT - 1998 & NEWER



VF110011
FL - PERMIT PANEL - EMBLEM
CUTOUT - RIGHT -
1998 & NEWER



VF110012
FL - PERMIT PANEL - BLANK -
RIGHT - 1998 & NEWER

FUEL TANK FAIRING

BRACKETS AND MOUNTING HARDWARE INCLUDED
NOT AVAILABLE IN 430 STAINLESS



VF150001
FL - FUEL TANK FAIRINGS -
82" - PAIR



VF150002
FL - FUEL TANK FAIRINGS -
87" - PAIR

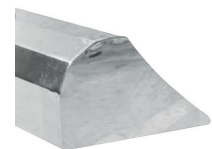

STAINLESS ACCESSORIES

INTERNATIONAL



Bumpers and Stainless Accessories made in the USA



www.valleychrome.com

STAINLESS ACCESSORIES

INTERNATIONAL



VI130003

INTL - 12" DROP VISOR 2PC
FITS PROSTAR & LONESTAR



VI135003

INTL - 12" TAPERED TO 16" IN CENTER
WICKED DROP VISOR - 2PC
FITS PROSTAR & LONESTAR

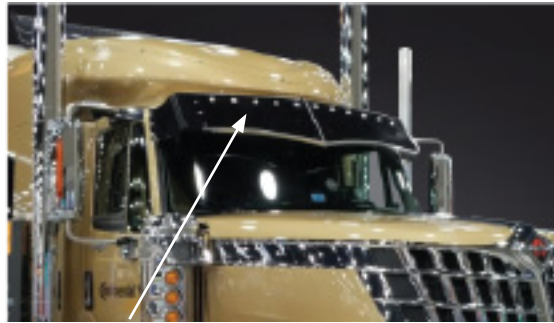

VI135003-10BYCA

ADD LIGHTS TO YOUR VISOR OR PANEL - SEE PAGES 106-107

VI120107

INTL - BUG SHIELD FITS MODEL 9900
STAINLESS STEEL
RUBBER TRIM & MOUNTING HARDWARE INCLUDED



VI110200

INTL - CAB PANELS - FITS MODELS 9200,9300,9400
STAINLESS STEEL



STAINLESS ACCESSORIES

VOLVO VNL



Bumpers and Stainless Accessories made in the USA



www.valleychrome.com

STAINLESS ACCESSORIES

VOLVO VNL

HOOD & FENDER TRIM



VV120002
FENDER GUARD - UPPER -
780 SERIES
TAPE MOUNT



VV100003
FENDER GUARD - UPPER -
780 SERIES
TAPE MOUNT



BUG SHIELD

MOUNTING HARDWARE INCLUDED



VV120107
BUG DEFLECTOR 630, 670, 780,
830, 880 SERIES



STAINLESS TRIM FOR FACTORY VISORS



VV130000
VISOR INSERT - 700, 800
SERIES



STAINLESS ACCESSORIES

VOLVO VNL

FAIRING HIGHLIGHTS

MOUNTS WITH STRONG 3M DOUBLE-SIDED TAPE



VV121000
FRONT FAIRING UPPER
STEP PANEL - PAIR



VV121001
FRONT FAIRING UPPER
STEP HIGHLIGHT
2PCS



VV121002
FRONT FAIRING LOWER
STEP PANEL - PAIR



VV121003
FRONT FAIRING LOWER
STEP HIGHLIGHT



VV121004
FRONT FAIRING LOWER
STEP BOTTOM HIGHLIGHT



VV121005
REAR FAIRING UPPER
STEP HIGHLIGHT

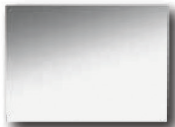

VV121006
REAR FAIRING LOWER
STEP PANEL



VV121007
REAR FAIRING LOWER
STEP HIGHLIGHT



VV121008
REAR FAIRING LOWER
STEP BOTTOM HIGHLIGHT



STAINLESS ACCESSORIES

VOLVO VT SERIES



Bumpers and Stainless Accessories made in the USA



www.valleychrome.com

STAINLESS ACCESSORIES

VOLVO VT SERIES

CAB PANELS

MOUNTING HARDWARE INCLUDED



VV112000
CAB PANELS 880/830 - BLANK
- NO SIDE FAIRING



EXAMPLE
VV112000-4GA

ADD LIGHTS TO YOUR PANEL - SEE PAGES 106-107

SLEEPER PANELS

MOUNTING HARDWARE INCLUDED



VV143000
SLEEPER PANELS - BLANK -
WITH NO SIDE FAIRINGS



EXAMPLE
VV143000 - 5UN



EXAMPLE
VV143000- 5RN



EXAMPLE
VV143000 - 7RA



EXAMPLE
VV143000 - 4GA

STAINLESS ACCESSORIES

VOLVO VT SERIES

HOOD EXTENSION PANELS

MOUNTING HARDWARE INCLUDED

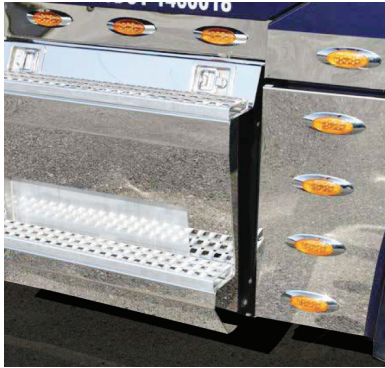

VV110300
HOOD EXTENSION PANEL
- BLANK



EXAMPLE
VV110300-4GA

ADD LIGHTS TO YOUR PANEL - SEE PAGES 106-107

HOOD & FENDER TRIM



VV100000
HEADLIGHT TRIM - SIDE -
830, 880 SERIES
TAPE MOUNT



VV100001
TOP FENDER TRIM - 830,
880 SERIES
TAPE MOUNT



STAINLESS ACCESSORIES

VOLVO VT SERIES

HOOD & FENDER TRIM

MOUNTS WITH STRONG 3M DOUBLE-SIDED TAPE



VV120000
FENDER GUARD - UPPER -
830, 880 SERIES



VV120001
FENDER GUARD - LOWER -
830, 880 SERIES

BUG SHIELD

MOUNTING HARDWARE INCLUDED



VV120107
BUG DEFLECTOR 630, 670, 780,
830, 880 SERIES



SUN VISORS

MOUNTING HARDWARE INCLUDED



VV130005
DROP VISOR - 830 MID-ROOF



STAINLESS ACCESSORIES

VOLVO VT SERIES

BATTERY BOX COVER

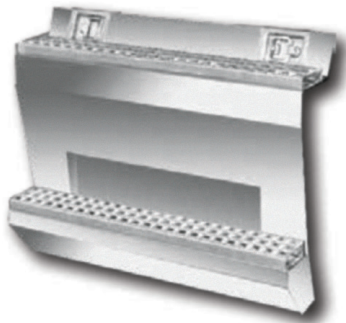

VV150000
BATTERY BOX COVER - 830
VOLVO - 8PCS



FUEL TANK FAIRINGS



VV150001
FUEL TANK FAIRINGS - 68"

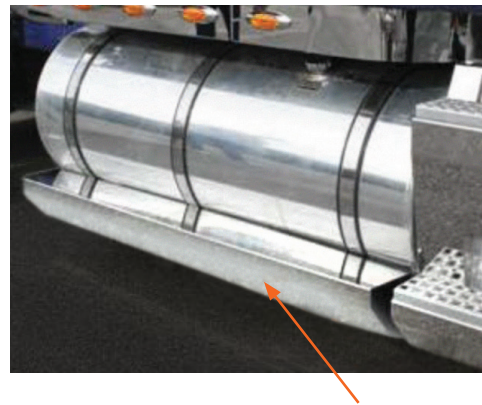

STAINLESS ACCESSORIES

WESTERN STAR 4700SF



PARTS LIST:

- | | | |
|----------|---------------|--|
| 1 | IM-2110-06 | Chrome Bumper (Call for Options & Price) |
| 2 | VW120005 | Fender Guards (Fitted) |
| 3 | VW120006 | Upper Fender Guards (Rolled) |
| 4 | VW110200-8GMA | Cab Panel Line
(Cab Panels with Granite Amber Lights Shown) |
| | VW110200 | Blank Cab Panels w/Heater
Plug Holes (Not Pictured) |
| | VW110201 | Blank Cab Panels (Not Pictured) |
| 5 | VW130001 | 12" Visor - 2013 & Newer |
| 6 | VW120010 | Bug Shield - Stainless Steel |
| 7 | VW120011 | Bug Shield - Stainless Steel - "W" Look |
| 8 | VW120201 | Lower Radiator Rock Guard |

STAINLESS ACCESSORIES

WESTERN STAR 4700SF YEARS 2013 & NEWER CAB PANELS

MOUNTING HARDWARE INCLUDED



VW110200
WS CAB PANELS - 2013 AND
NEWER - 4700 SF - BLANK W/
HEATER PLUG HOLE



VW110201
CAB PANELS - BLANK - NO
SIDE FAIRING - 4PCS

ADD LIGHTS TO YOUR PANEL - SEE PAGES 106-107

FENDER GUARDS



VW120005
WS FENDER GUARDS - FITTED -
4700 SF 2013 AND NEWER
HARDWARE INCLUDED

VW120006
WS UPPER FENDER GUARD
- FITTED 4700 SF 2013
AND NEWER
TAPE MOUNT



BUG SHIELDS

BRACKETS & MOUNTING HARDWARE INCLUDED



VW120010
PB BUG SHIELD - STAINLESS
- 4700 SF 2013 AND NEWER



VW120011
WS BUG SHIELD - "W" STYLE
- STAINLESS - 4700 SF 2013
AND NEWER

RADIATOR ROCK GUARD



VW120201
WS LOWER RADIATOR
GUARD - 2013 AND NEWER
4700 SF

SUN VISORS

BRACKETS & MOUNTING HARDWARE INCLUDED



VW130001
WS 12" VISOR 2013 AND NEWER
4700 SF



STAINLESS ACCESSORIES

5700XE YEARS 2015 & NEWER SUN VISORS

BRACKETS & MOUNTING HARDWARE INCLUDED

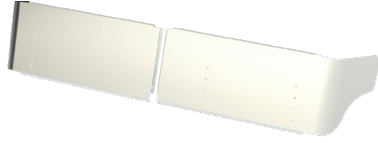

VW130002
WS SUNVISOR - 13.5" WIDE
5700XE STAINLESS

ADD LIGHTS TO YOUR VISOR - SEE PAGES 106-107

For more info on bumpers for this model, see page 85

BUG SHIELDS

MOUNTING HARDWARE INCLUDED



VW120014
WS BUGSHIELD
5700XE STAINLESS



STAINLESS ACCESSORIES

47X/49X SETBACK AXLE YEARS 2021-NEWER VISORS



VW130003
12" DROP VISOR



VW130004
15" DROP VISOR



VW130004
15" DROP VISOR
(REAR VIEW)



49X SETBACK AXLE YEARS 2022-NEWER SLEEPER EXTENSION PANEL



VW142100
SLEEPER EXTENSION
PANEL
ISO VIEW



VW142100
SLEEPER EXTENSION
PANEL

49X SETBACK AXLE YEARS 2022-NEWER AIR INTAKE SCREEN



VW100000
AIR INTAKE SCREEN
ISO VIEW

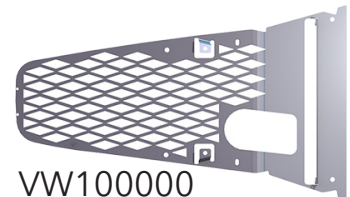

VW100000
AIR INTAKE SCREEN

49X SETBACK AXLE YEARS 2021 & NEWER CAB PANELS



VW110202
CAB PANELS - BLANK
(FITS TRUCKS WITH CAB MOUNTED EXHAUST)



VW142000
60" SLEEPER PANEL - BLANK
(FITS TRUCKS WITH CAB MOUNTED EXHAUST)



VW110203
COWEL PANEL

**THE ORIGINAL
TURBOWING
BY**



STAINLESS ACCESSORIES

TURBOWING



THE TURBOWING ADVANTAGE

“The Original Turbowing” is the Grand-Daddy of all air deflectors. This size, shape and design is today’s air deflector of choice and will be for another 30 years. Impeccable over the road performance records make it one of the most popular accessories in the industry today, because Turbowing works. Proven efficiency saves truckers thousands of dollars in fuel costs each year. Get started today!

DURABILITY:

Turbowing “Tough” is the term unmatched in the trucking industry today. A rugged over-the-road environment remains a real-life “Tell-tale” test for big rig accessories. Some air deflectors are giving in to this harsh reality, Turbowings remain solid and continue to prove their worth, trip after trip!

FUNCTIONAL:

Testimonials from owner operators have shown consistent fuel savings of approximately **10% up to 19%**. for the average owner/operator, this means payback for their Turbowing investment in less than six months.

EXAMINE THIS LIST OF FEATURES OFFERED ONLY BY STAINLESS COMPANY:

- Highest quality materials and hardware.
- Pre-formed body panels to reduce undue stress on rivets.
- Sleeper specific brackets attach to the strongest points of the sleeper at the factory-built supports.
- Fixed angle brackets ensure the correct angle for deflection of air, no fooling around.
- Full application range to fit all popular sleeper sizes in flat-top and raised roofs.
- Paccar approved, one of the only wing-styled air deflectors available through Paccar’s parts division.
- Tested and proven so you gain every time.

STAINLESS ACCESSORIES

TURBOWING

PICKUP TRUCK WINGS

HIGHLIGHTS OF THE STAINLESS LINE OF AIR DEFLECTORS

- 30% reduction in drag.
- Wings are available in mirror polished stainless steel.
- Reduced "bug splatter" on the front of the trailer.
- Enhances stability in windy situations.
- Increased towing speed.
- The ability to pass other large vehicles without getting bogged down or blown around from on-coming wind.
- No drilling required with easy on and off clip mount system. (For most full size domestic pickup trucks 3/4 ton and up)

DESIGNED TO IMPROVE YOUR TOW PACKAGE

Towing a 5th wheel trailer, gooseneck race car trailer with a pickup truck or big rig semi truck means you are fighting the wind. STAINLESS builds a stylish wing to deflect air over the trailer and maximize fuel economy every time you tow.

Going camping? Want to get better fuel mileage towing on the way to and from your destination but just want the most economical way to save fuel? Use STAINLESS air deflectors.

TURBOWING UNIVERSAL CLIP-ON/BOLT-ON WING

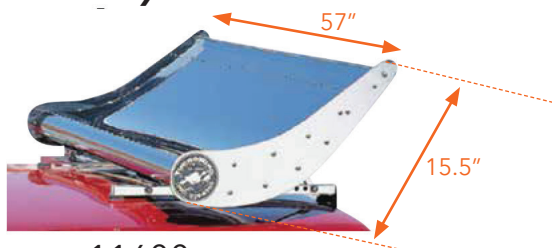

11600

DODGE, CHEVY, FORD - POWER
*SEE UNIVERSAL MOUNTING KITS

HIGH PROFILE UPGRADE KIT



11603

11600 UPGRADE KIT, MINI WING, END PLATES, BOLT KITS

APPLICATION	CAB STYLE	CLIP-ON KIT	BOLT-ON KIT
2001 - 2006 Chevy & GMC (2500-3500)	Extended w/4-door	10244	11703
2001 - 2006 Chevy & GMC (2500-3500)	Extended w/ small door	10244	11703
2001 - 2006 Chevy & GMC (2500-3500)	Crew cab	10249	11704
2007 & Newer Chevy & GMC (2500-3500)	Extended cab	17249	11703
2007 & Newer Chevy & GMC (2500-3500)	Crew cab	17249	11704
2010-2014 Chevy	Crew cab	10258	(N/A)
2015 Chevy	Crew cab	10256	(N/A)
1980 -1997 Ford	All cabs w/rain gutters	11230	CALL
1998 & Newer Ford Standard,	Extended w/4-door, Crew	10237	10601
2015 Ford 3/4 ton to 1 ton	Super Crew	10257	(N/A)
1994-2002 Dodge (1500-3500)	All cabs	10251	(N/A)
2003-2010 Dodge	All cabs	10252	11706
2013 & Newer Dodge	All cabs	10254	(N/A)

STAINLESS ACCESSORIES

TURBOWING

AEROLIGHT 700 SERIES



- 38" Rail
- 76"L X 26"D X 20"H
- Ideal size and function for all stand-up high-roof sleepers
- Downsized, identical design/function as the Turbowing 1.
- Conforms to industry height restrictions.
- Preset wing angle for optimum performance.
- Polished stainless bracketry.
- Polished stainless available for most standups.



900 SERIES

The Turbowing 900 Series was originally developed for the lower roof flat-top style sleepers where the height of the trailer was significantly taller than the roof of the truck. This design boasts bold, sharp looks, and works extremely well at increasing fuel mileage.

Standard 900 Series

- Weight 125 lbs.
- 76"L X 30"D X 30"H
- Wing body: mirror polished stainless
- Brackets: polished stainless steel
- Adjustment: preset per sleeper/trailer height
- Fuel mileage increase: approx. 10%
- Drag/wing resistance reduction: 30%
- For most flat-top sleepers
- Warranty: 3 year limited



STAINLESS ACCESSORIES

TURBOWING

PETERBILT WINGS



711
HIGH ROOF/STANDUP SLEEPERS



911
FLAT TOP/ C/O CABOVER

MOUNTING KITS

AEROLIGHT 700 - PETERBILT

48700
48" HR - HIGH ROOF/
STANDUP SLEEPER

63700
63"/72" HR - HIGH ROOF/
STANDUP SLEEPER

70700
70" HR - HIGH ROOF/STANDARD OR
UNIBILT SLEEPER

AEROLIGHT 900 - PETERBILT

63900
63"/72" STD FT - STANDARD
FLATTOP NON-UNIBILT

50900
48" STD FT - STANDARD
NON-UNIBILT

36900
36" STD FT - STANDARD
NON-UNIBILT

63900U
63"/72" STD FT - STANDARD
FLATTOP UNIBILT

90900
90" C/O CAB OVER



VU190021
TURBOWING BRACKET
STAND-UP SLEEPERS (PB, KW, FL)

HOOD WINGS

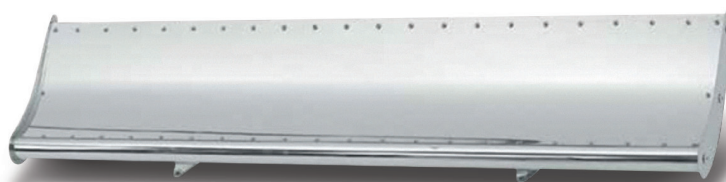

11131
HOOD WINGS - POWER STYLE -
UNIVERSAL (EXCEPT KW) 42" X 9" X 6"

STAINLESS ACCESSORIES

TURBOWING

KENWORTH WINGS



711
ALL HIGH ROOF SLEEPERS



911
AEROCAB INTEGRAL/ STANDARD
FLATTOP/ CAB OVERS

MOUNTING KITS

AEROLIGHT 700 - KENWORTH

KW700
ALL HR - HIGH ROOF SLEEPERS
60", 62", 72", 74", & 86" AERODYNE I, II, STUDIO SLEEPERS & STAND UP AEROCAB

AEROLIGHT 900 - KENWORTH

62900
62" ING - AEROCAB
INTEGRAL FLATTOP

60900
60" STD FT -
STANDARD FLATTOP

42900
42" STD FT -
STANDARD FLATTOP

72900
72" ING - AEROCAB
INTEGRAL FLATTOP

49900
50" STD FT -
STANDARD FLATTOP

37900
36" STD FT -
STANDARD FLATTOP



VU190021
TURBOWING BRACKET
STAND-UP SLEEPERS (PB, KW, FL)

HOOD WINGS

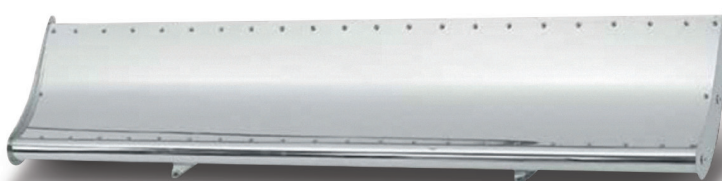

11151
HOOD WINGS POWER STYLE
42" X 9" X 3"

STAINLESS ACCESSORIES

TURBOWING

FREIGHTLINER WINGS



711

HI-STYLE/STANDARD RAISED
ROOF/MID ROOF INTEGRAL



911

STANDARD INTEGRAL/STANDARD
FLATTOP/CAB OVER

MOUNTING KITS

AEROLIGHT 700 - FREIGHTLINER

FX711

BUSINESS CLASS FL50, FL60, FL70, FL80, FL106, FL112, M2(72") WING & BRKTS SOLD TOGETHER

56700

58" MR ING - MID ROOF INTEGRAL

69700

70" MR ING - MID ROOF INTEGRAL

TURBOWING 900 - FREIGHTLINER

70900

70" ING - STANDARD INTEGRAL
SLEEPER CAB

47900

48" ING - STANDARD INTEGRAL
SLEEPER CAB

49900

50" STD FT - STANDARD FLATTOP
SLEEPER BOX

57900

58" ING - STANDARD INTEGRAL
SLEEPER CAB

58900

60" STD FT - STANDARD FLATTOP
SLEEPER BOX

39900

40" STD FT - STANDARD FLATTOP
SLEEPER BOX

86900

86" C/O - CAB OVER



VU190021

TURBOWING BRACKET
STAND-UP SLEEPERS (PB, KW, FL)

HOOD WINGS

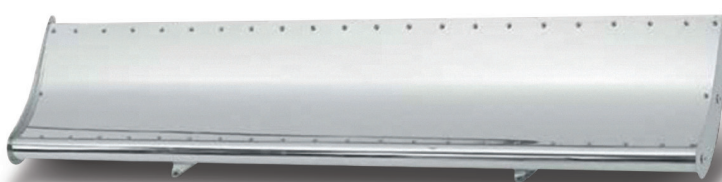

11131

HOOD WINGS - POWER STYLE -
UNIVERSAL (EXCEPT KW) 42" X 9" X 6"

STAINLESS ACCESSORIES

TURBOWING

INTERNATIONAL WINGS



711
HIGH ROOF/STANDUP SLEEPERS



911
FLAT TOP/ C/O CABOVER

MOUNTING KITS

51700
51" H/R - HI-RISE INTEGRAL
PRO SLEEPER

72700
72" H/R - HI-RISE INTEGRAL
PRO SLEEPER

TURBOWING 900 - INTERNATIONAL

73900
72" ING - LO-ROOF INTEGRAL
PRO SLEEPER

59900
60" STD FT -
STANDARD FLATTOP

41900
42" STD FT -
STANDARD FLATTOP

51900
51" ING - LO-ROOF
INTEGRAL PRO SLEEPER

48900
48" STD FT -
STANDARD FLATTOP

86900
86" C/O - CAB OVER

10900
110" C/O - CAB OVER

HOOD WINGS

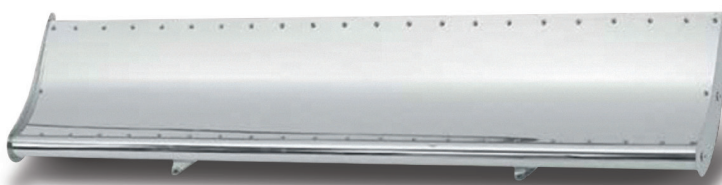

11131
HOOD WINGS - POWER STYLE - UNI-
VERSAL (EXCEPT KW) 42" X 9" X 6"

STAINLESS ACCESSORIES

TURBOWING

WESTERN STAR WINGS



AEROLIGHT 700 - WESTERN STAR

WESTERN STAR WINGS HAVE DIFFERENT C-C DIM. 60" SOLID WING & MOUNTING

WC711

70" CONST - CONSTELLATION SERIES



VU190021

TURBOWING BRACKET
STAND-UP SLEEPERS (PB, KW, FL)

HOOD WINGS

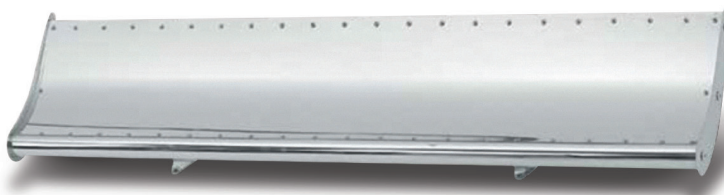

11131

HOOD WINGS - POWER STYLE -
UNIVERSAL (EXCEPT KW) 42" X 9" X 6"



STAINLESS ACCESSORIES

TURBOWING

PRO TAIL WINGS



VU194000
PRO TAIL 72" X 18" HIGH ROOF FLAT
TOPS ONLY



VU194001
PRO TAIL 70" X 11" HIGH ROOF FLAT
TOPS ONLY



VU194002
PRO TAIL 70" X 19" - WING VERSION
FLAT TOPS ONLY



WARRANTY & RETURNS

Thank you for choosing Valley Chrome bumpers and STAINLESS, a division of Valley Chrome Plating, Inc., as your source for chrome and stainless steel custom truck accessories. Our family of products is fully guaranteed for fit, appearance and quality. Our mission is to provide you with the finest products at a fair price. Our reputation has been built in the trucking industry on our commitment to you, the trucking industry professional.

LIMITED WARRANTY

STAINLESS extends a warranty against defects in material and workmanship for a period of one year. LED light assemblies come with a three year limited warranty. This warranty is void by damage or defects in appearance due to accident, abuse, alterations to the product, improper installation, corrosive environments or any other abnormal conditions. This warranty applies only to the original purchaser of the product and covers only the defective part, whether it is a single item or component part of a purchased group. The warranty year begins upon purchase of the product by the end user. All requests for warranty must include the original invoice. Serial numbers must be provided for bumpers, wings and any other serialized parts. There is no warranty for setback axle bumpers ("break-backs") 20" and wider. Flat bumpers 20" and wider may require additional brackets and bracing (not included) to avoid cracking, and may not be warranted if our company determines the bracing is insufficient.

RETURN POLICY

Products must be returned to our Clovis, Ca. facility with a Returned Goods Authorization number, freight prepaid. Items sent without an R.G.A. number or freight collect will be refused. STAINLESS reserves the right to repair or replace the item at our discretion. Warranted items will be returned freight prepaid upon acceptance of our responsibility of the defect. Please contact our customer service staff for the R.G.A. number. Items may not be returnable due to age or stored condition, which is at our company's discretion.

FREIGHT POLICY

All freight is F.O.B. from our Clovis, Ca. facility unless prepaid conditions are met.

Dealers/Distributors: see your published price list for the freight policy that applies to you. Bumpers, Turbowings, battery boxes and tool boxes can be combined to achieve prepaid status.

Accessories may be combined with bumper and/or wing orders at our discretion.

IMAGES IN THIS CATALOG

The images shown in this catalog are best representations of our products, however, they are representative only and may sometimes not match actual product. Add-on items shown in images, such as external tow apparatus, fog lamps and other non-Valley Chrome/STAINLESS items attached to bumpers and accessories are not included in the product offered.

UPDATED INFORMATION

Information in this catalog, when printed by our company, is made as accurate as possible at the time of printing. For the most current information, including error corrections, see the most current catalog posted on our website. Because of the truck and automotive industry's aftermarket publishing inconsistencies, some model years and vehicle models indicated in this publication may vary slightly from the actual model. Obtain product drawings and photos from our customer service staff to verify product fit prior to ordering.

VALLEY CHROME

: TRUCK PARTS :

Call for a Dealer Near You **1.800.354.0976**

www.valleychrome.com • 1028 HOBLITT AVE. • CLOVIS, CA 93612 • USA

FOLLOW US

